



PREMIUM
LITE LINE
NEW LINE

à la
carte
2022

Contents

Carcase.....	2
Visible sides.....	3 - 5
Heights of carcase and fronts.....	6 - 12
Glass.....	13
Blum LEGRABOX / MERIVOBX / TANDEMBOX.....	14 - 16
Melamine fronts	
TOUCH / TOUCH com.....	18
PORTO H/V wl / PORTO H/V wl com.....	19
SINCRONO H/V / SINCRONO H/V com.....	20
SHERWOOD HV / SHERWOOD H/V com.....	21
EDGE sincrono H/V / EDGE sincrono H/V com.....	22
EDGE sherwood H/V / EDGE sherwood H/V com.....	23
SMART H/V / SMART H/V com.....	24
CEMENTO / CEMENTO com.....	25
RUPE H/V / RUPE H/V com.....	26
METALL H/V / METALL H/V com.....	27
CROSS / CROSS com , STYLE.....	28
Matt-Line	
OPACO / OPACO com.....	30
FROST / FROST com.....	31
EXTREM / EXTREM com , URBAN / URBAN com.....	32
FENIX / FENIX com , ART-GLAS MATT.....	33
EFFECTO / EFFECTO com.....	34
CONCRETE.....	35
LUNA R2 / LUNA R2 com.....	36
LUNA R2 RAL / LUNA R2 RAL com.....	36
METALLICO / METALLICO com.....	37
LUNA MICRON / LUNA MICRON com.....	38
LUNA SOFT / LUNA SOFT com.....	39
INSPIRATION SOFT.....	40
ELEGANCE SOFT.....	41
MILA SOFT.....	42
High-gloss Line	
SILK / SILK com.....	44
ESPRIT / ESPRIT com.....	45
LUCE / LUCE com.....	46
LUCE INFINITY / LUCE INFINITY com.....	47
PASSION / PASSION com.....	48
PASSION R2 RAL.....	48
LUCIDA / LUCIDA com.....	49
ART-GLAS GLOSS.....	50
Foil-wrapped fronts	
GROOVE matt.....	52
CASTLE matt, MEDA matt.....	53
MODERNO matt, STEP matt.....	54
Wood	
TOSCANA.....	56
Oak-Line	
REAL-OAK H/V.....	58
EDGE REAL-OAK H/V.....	59
LAMELLA anticato.....	60
NOTCHO.....	60
PLANK-OAK anticato.....	61
ROUGH zero + R15.....	61
CADRE anticato.....	62
BLACK-LINE.....	62
MERINO anticato.....	63
SPLIT-OAK H/V anticato.....	64
INTENSE H/V.....	64
LEGNO H/V.....	65
TELAIO anticato.....	65
INCAVO anticato.....	66
ORBITA anticato.....	66
STRETTO anticato.....	67
RIPIENO anticato.....	67
Handles, worktop decors, colour charts and discontinued lines	
Handles.....	69 - 73
Worktop decors.....	74 - 77
Colour charts.....	78 - 85
Discontinued lines 2021.....	86

Legend

N	NEW
GL	Handleless (flatdoor)
GLD E/B	Handleless decor (flatdoor), profile stainless steel or black
GLV E/B	Handleless (door with 45° chamfer + metal-strip) metal-strip stainless steel or black
GLXE	Handleless (door with 90° routing + stainless steel strip)
GLV 45	Handleless (door with 45° chamfer)
GLX 90	Handleless (door with 90° routing)
GLU	Handleless (wooden door with U-routing)

ELarge  Extra-large, crockery cabinets with one-piece full-height doors can be supplied up to 195 cm high in **wood decor**, and up to 234 cm in **unicolours**

EWide  Extra-wide pull-outs and flaps available as a special size up to max. 180 cm

XTend  Tall unit fronts available with full-height doors (without filler panels)

COM Range available with **COM strip rounded 996, square 997 and down 995**

CLA  Some appliance housing units require a different front partition (see price list) for the COM/ARTE ranges

Carcase

KS Carcase inside and outside in colour
* to choice, no carcase in front colour available

Visible sides

if required, please specify when ordering!
(Wood decors always with vertical graining)

-	none required
KS	Melamine
WL	Woodline
ST	Texture
UM	Ultra-matt
SM	HPL matt
SMF	HPL matt Fenix
SMFi	HPL matt Fenix inox
XTR	HPL matt Extrem
SZ	HPL soft cement
UVM	UV matt lacquered
ACM	Acryl matt
ML	Matt lacquered
MLMI	Matt lacquered Micron
MLSO	Matt lacquered Soft
BT	Concrete
LM	Lacquered metal look
EG	Fine gloss
SG	HPL gloss
ACG	Acryl gloss
UVHG	UV high gloss
LG	High-gloss lacquered
FL	Veneered lacquered
FA	Veneered anticato (sandblasted or brushed, then lacquered)
FR	Veneered anticato (Rough/Intense)

Panels

-	not available
KS	Melamine*
WL	Woodline
EST	Texture, black/snow edge
ST	Texture
UM	Ultra-matt
SM	HPL matt
SMF	HPL matt Fenix*
SMFi	HPL matt Fenix inox
XTR	HPL matt Extrem*
SZ	HPL soft cement
UVM	UV matt lacquered
ACM	Acryl matt
ML	Matt lacquered
MLMI	Matt lacquered Micron
MLSO	Matt lacquered Soft
BT	Concrete
LM	Lacquered metal look

EG	Fine gloss
SG	HPL gloss
ACG	Acryl gloss
UVHG	UV high gloss
LG	High-gloss lacquered
FL	Veneered lacquered
FA	Veneered anticato (sandblasted or brushed, then lacquered)
FR	Veneered anticato (Rough/Intense)
FS	Veneered sierrado (saw-cut look, lacquered)

Cornice / Light pelmet

OZ 14	 Light pelmet melamine or matt lacquered
OZ 15	 Cornice melamine or matt lacquered
OZ 36	 Light pelmet melamine or matt lacquered
OZ 37	 Cornice melamine or matt lacquered
OZ 40	 Light pelmet mit Holzstruktur, lackiert (FL)
OZ 41	 Kranzleiste mit Holzstruktur, lackiert (FL)
OZ 53	 Cornice melamine or matt lacquered
OZ 54	 Light pelmet melamine or matt lacquered

Pilasters (Shaker)

K	Pilaster, foil-wrapped
M	Pilaster solid square, lacquered

Plinth panels

When ordering, please specify if a surface other than KS is required! (Wood decors always horizontal graining)

-	not available
KS	Melamine
WL	Woodline horizontal (max. 260 cm)
ST	Texture horizontal (max. 260 cm)
UM	Ultra-matt (max. 260 cm)
SM	HPL matt
SMF	HPL matt Fenix
SMFi	HPL matt Fenix inox
XTR	HPL matt Extrem
SZ	HPL soft cement
UVM	UV matt lacquered
ACM	Acryl matt
ML	Matt lacquered
MLMI	Matt lacquered Micron
MLSO	Matt lacquered Soft
BT	Concrete (max. 250 cm)
LM	Lacquered metal look
EG	Fine gloss (max. 260 cm)
SG	HPL gloss
ACG	Acryl gloss
UVHG	UV high gloss
LG	High-gloss lacquered
FL	Veneered lacquered (max. 260 cm)
FA	Veneered anticato (max. 260 cm) (sandblasted or brushed, then lacquered)
FR	Veneered anticato (Rough/Intense, max. 260 cm)

Open shelving

When ordering, please specify if a surface other than KS is required! (Wood decors always with vertical graining)

-	Colour not available
KS	Melamine*
WL	Woodline
ST	Texture
UM	Ultra-matt
SM	HPL matt
EG	Fine gloss
SG	HPL gloss
FL	Veneered lacquered
FA	Veneered anticato (sandblasted or brushed, then lacquered)

Carcase finishes

PREMIUM LINE

Carcase as standard in same decor inside and outside with PP edging



bianco 006



black 008



carbon 063



fango 014



graphite 017



grigio 095



halifax crack oak 199 



cashmere 024



pebble-grey 064



magnolia 090



natural knotty oak 028

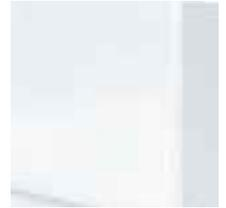

optiwhite 007



sharky 126



snow 101



vicenza oak claire 153

All wood decors with textured surface (WL/ST)



Carcase finishes

LITE LINE

Carcase as standard in same decor inside and outside with PP edging



dolphin 123

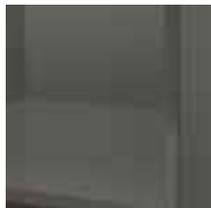

slate 128



Carcase finishes

NEW LINE

Carcase as standard in same decor inside and outside with PP edging



bianco 006

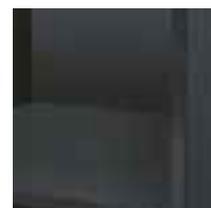

carbon 063



On carcasses with visible sides the front edge of the visible sides (only this one) is in the colour of the visible sides. All other edges are in carcasse colour. As a result of differences in material and texture, the colours of visible sides can deviate slightly from the colours of the fronts.

VISIBLE SIDES AT NO EXTRA CHARGE

VISIBLE SIDE:	CARCASE:	VISIBLE SIDE:	CARCASE:	VISIBLE SIDE:	CARCASE:
KS melamine		WL Woodline		EG Fine gloss	
dolphin	to choice	denver-oak	to choice	bianco	bianco
moss	to choice	oak bardolino	to choice	cashmere	cashmere
muscata	to choice	graphite	graphite	optiwhite	optiwhite
slate	to choice	nordic	to choice	UM Melamine ultra-matt	
WL Woodline		sanremo oak	to choice	bianco	bianco
bianco	bianco	stormy oak	to choice	magnolia	magnolia
darkwood	to choice			snow	snow

VISIBLE SIDES AT EXTRA CHARGE

ST Texture	SZ HPL soft cement	MLSO - Matt lacquered Soft
amber (N) to choice	cement white to choice	midnight blue to choice
argento (N) to choice	BT Concrete	moos to choice
ash to choice	clair-light to choice	olive to choice
basalt dunkel to choice	fonce-dark to choice	seta (N) to choice
black (Cemento) black	moyen-medium to choice	fir green to choice
black (Metall) black	super-bright to choice	urbano (N) to choice
bronze to choice	UVM Matt lacquered	LM Lacquered metal look
brown to choice	anthracite to choice	bronze dark to choice
halifax crack oak (N) halifax crack oak	aqua (N) to choice	bronze light to choice
halifax nature to choice	bianco bianco	silver to choice
halifax white to choice	black (N) black	titanium to choice
knotty oak to choice	carbon carbon	MT - Metallic
light grey to choice	crush gold to choice	bronze oxide to choice
light oxide to choice	dolphin to choice	copper to choice
reno to choice	fango fango	gold to choice
sand to choice	cashmere cashmere	platinum to choice
sherwood black black	pebble-grey pebble-grey	ACM - Acrylic matt
sherwood burned wood to choice	laguna (N) to choice	terricio to choice
sherwood bushy park to choice	ocean to choice	titanio to choice
sherwood cigar to choice	slate to choice	SG HPL gloss
sherwood engadina to choice	snow (N) snow	bianco bianco
sherwood graphite (N) graphite	steel gold-brown to choice	grigio grigio
sherwood greenwich to choice	ML - Matt lacquered	magnolia magnolia
sherwood nature to choice	snow snow	optiwhite optiwhite
sherwood richmond to choice	RAL/Sikkens/NCS colours to choice	snow snow
dark steel to choice	MLMi - Matt lacquered Micron	LG High-gloss lacquered
steel blue to choice	bianco bianco	bianco bianco
light umbra to choice	black black	snow snow
XTR HPL matt Extrem	blue grey to choice	RAL/Sikkens/NCS colours to choice
black black	graphite graphite	UVHG Lacquer high-gloss
graphite graphite	midnight blue to choice	anthracite to choice
cashmere cashmere	peach to choice	azure blue to choice
optiwhite optiwhite	rost to choice	black black
sharky sharky	sharky sharky	blue grey to choice
snow snow	snow snow	lemon to choice
SM HPL matt	tannengrün to choice	onyx grey to choice
bianco bianco	taupe to choice	red to choice
magnolia magnolia	RAL/Sikkens/NCS colours to choice	
optiwhite optiwhite	MLSO - Matt lacquered Soft	
SMF HPL matt Fenix	bianco bianco	
bianco bianco	black black	
black black	carbon carbon	
bromo to choice	graphite graphite	
cacao to choice	cashmere cashmere	
light grey to choice	pebble-grey pebble-grey	
kos white bianco	londra to choice	
londra to choice	magnolia magnolia	
midnight blue to choice	marone (N) to choice	
optiwhite optiwhite		
rosso to choice		
verde to choice		

Visible sides

PREMIUM LINE

On carcasses with visible sides the front edge of the visible sides (only this one) is in the colour of the visible sides. All other edges are in carcass colour. As a result of differences in material and texture, the colours of visible sides can deviate slightly from the colours of the fronts.

VISIBLE SIDES AT EXTRA CHARGE

VISIBLE SIDE:	CARCASS:	VISIBLE SIDE:	CARCASS:	VISIBLE SIDE:	CARCASS:
ACG - Acrylic glossy		FR Veneered Anticato (Rough/Intense/Notcho/Legno)		FA Veneered Anticato	
bianco	bianco	black	Ⓝ black	beachwood	to choice
black	black	graphite	graphite	bianco	bianco
fumo	to choice	nature	Ⓝ to choice	black	black
cashmere	cashmere	pastell loam	to choice	chalk	to choice
snow	snow	pastell shadow	to choice	driftwood	to choice
FL veneered lacquered		pastell smoke	to choice	graphite	graphite
bianco	bianco	plage	to choice	chestnut	to choice
black	black	walnut	Ⓝ to choice	loam	to choice
graphite	graphite			nature/natural asteiche	to choice
magnolia	magnolia			real-nature	to choice
RAL/Sikkens/NCS colours	to choice			tiramisu	to choice
				RAL/Sikkens/NCS colours	to choice

Visible sides

LITE LINE

On carcasses with visible sides the front edge of the visible sides (only this one) is in the colour of the visible sides. All other edges are in carcass colour. As a result of differences in material and texture, the colours of visible sides can deviate slightly from the colours of the fronts.

VISIBLE SIDES AT NO EXTRA CHARGE

VISIBLE SIDE:	CARCASS:	VISIBLE SIDE:	CARCASS:	VISIBLE SIDE:	CARCASS:
KS melamine		WL Woodline		UM Melamine ultra-matt	
bianco	to choice	denver-oak	to choice	bianco	to choice
grigio	to choice	oak bardolino	to choice	snow	to choice
cashmere	to choice	natural knotty oak	to choice	EG Fine gloss	
pebble-grey	to choice	sanremo oak	to choice	bianco	to choice
moss	to choice	stormy oak	to choice	cashmere	to choice
optiwhite	to choice	vicenza oak claire	to choice	optiwhite	to choice
sharky	to choice				
snow	to choice				

VISIBLE SIDES AT EXTRA CHARGE

VISIBLE SIDE:	CARCASS:	VISIBLE SIDE:	CARCASS:	VISIBLE SIDE:	CARCASS:
ST Texture		SM HPL matt		SG HPL gloss	
amber	Ⓝ to choice	bianco	to choice	bianco	to choice
argento	Ⓝ to choice	optiwhite	to choice	magnolia	to choice
ash	to choice	UVM Matt lacquered		optiwhite	to choice
basalt dunkel	to choice	anthracite	to choice	snow	to choice
black (Metall)	to choice	aqua	Ⓝ to choice	UVHG Lacquer high-gloss	
brown (Metall)	to choice	bianco	to choice	anthracite	to choice
halifax nature	to choice	black	Ⓝ to choice	azure blue	to choice
halifax white	to choice	carbon	to choice	black	to choice
knotty oak	to choice	crush gold	to choice	blue grey	to choice
light grey	to choice	dolphin	delphin	lemon	to choice
light oxide	to choice	fango	to choice	onyx grey	to choice
sand	to choice	cashmere	to choice	red	to choice
sherwood burned wood	to choice	pebble-grey	to choice	LG High-gloss lacquered	
sherwood bushy park	to choice	laguna	Ⓝ to choice	bianco	to choice
sherwood engadina	to choice	ocean	to choice	snow	to choice
sherwood graphite	Ⓝ to choice	slate	slate		
sherwood nature	to choice	snow	Ⓝ to choice		
dark steel	to choice	steel gold-brown	to choice		
steel blue	to choice	ML - Matt lacquered			
light umbra	to choice	snow	to choice		

On carcasses with visible sides the front edge of the visible sides (only this one) is in the colour of the visible sides. All other edges are in carcass colour. As a result of differences in material and texture, the colours of visible sides can deviate slightly from the colours of the fronts.

VISIBLE SIDES AT NO EXTRA CHARGE

VISIBLE SIDE:	CARCASS:	VISIBLE SIDE:	CARCASS:	VISIBLE SIDE:	CARCASS:
KS melamine		WL Woodline		UM Melamine ultra-matt	
fango	to choice	bianco	bianco	bianco	bianco
grigio	to choice	graphite	to choice	magnolia	to choice
cashmere	to choice	natural knotty oak	to choice	EG Fine gloss	
magnolia	to choice	nordic	to choice	bianco	bianco
muscata	to choice	sanremo oak	to choice	cashmere	to choice
		vicenza oak claire	to choice	optiwhite	to choice

VISIBLE SIDES AT EXTRA CHARGE

ST Texture		SM HPL matt		UVHG Lacquer high-gloss	
basalt dunkel	to choice	bianco	bianco	anthracite	to choice
halifax white	to choice	magnolia	to choice	azure blue	to choice
light grey	to choice	SG HPL gloss		black	to choice
light oxide	to choice	bianco	bianco	blue grey	to choice
		grigio	to choice	lemon	to choice
		optiwhite	to choice	onyx grey	to choice
		snow	to choice	red	to choice

dimensions in mm

S 126 WALL UNITS

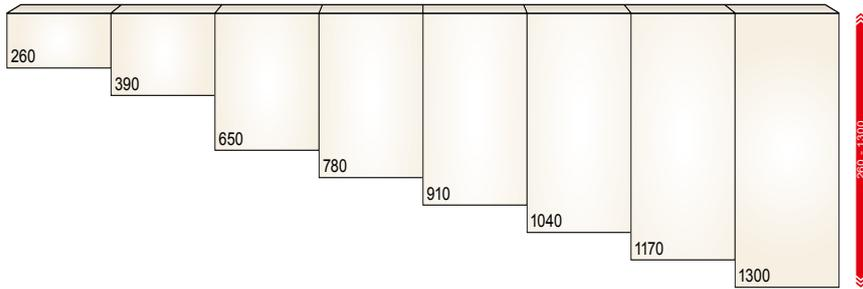

S 126 BASE UNITS

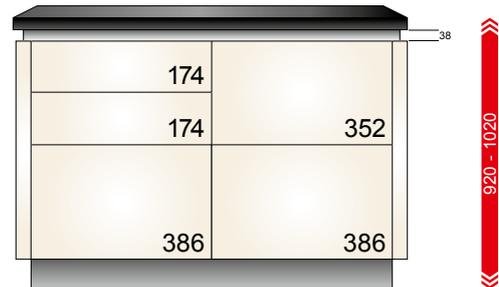
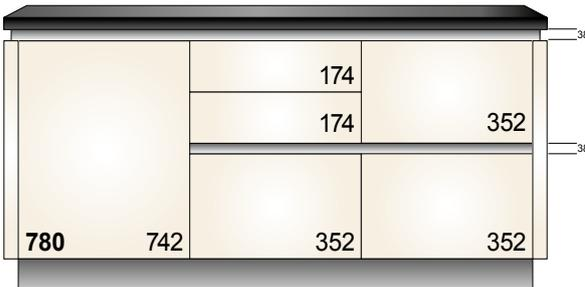

S 126 TALL UNITS

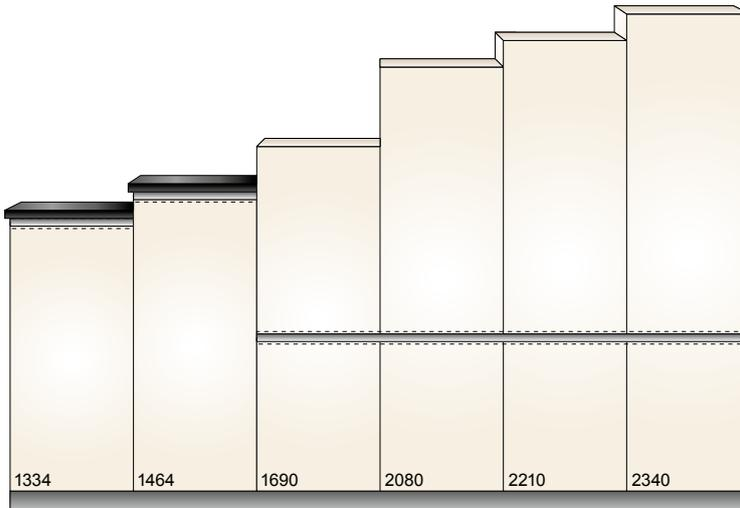

- GL
- GLD E/B
- GLV E/B
- GLX E
- GLV 45
- GLX 90
- GLU

S 126 COMBINATION OF BASE, TALL AND WALL UNITS

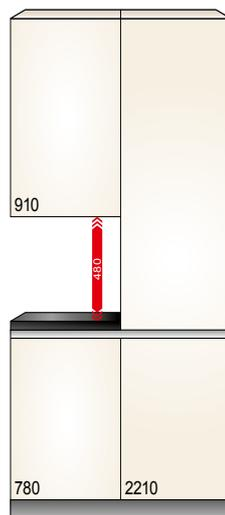
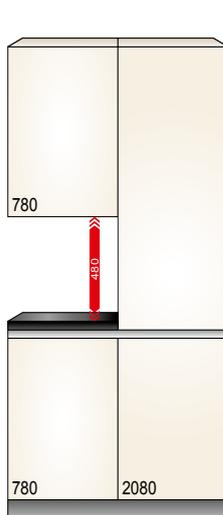

- GL
- GLD E/B
- GLV E/B
- GLX E
- GLV 45
- GLX 90
- GLU

dimensions in mm

WALL UNITS

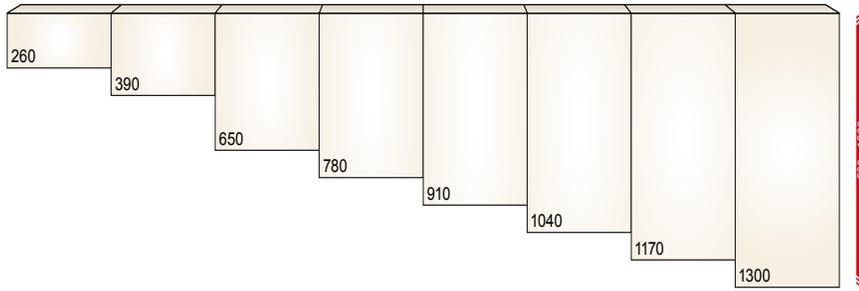

BASE UNITS

		126	126		126	126	126	
			256	386	126	126	126	256
					126	126	256	256
					126			
					126			
780	776	646	386	386	126	256	256	256

TALL UNITS

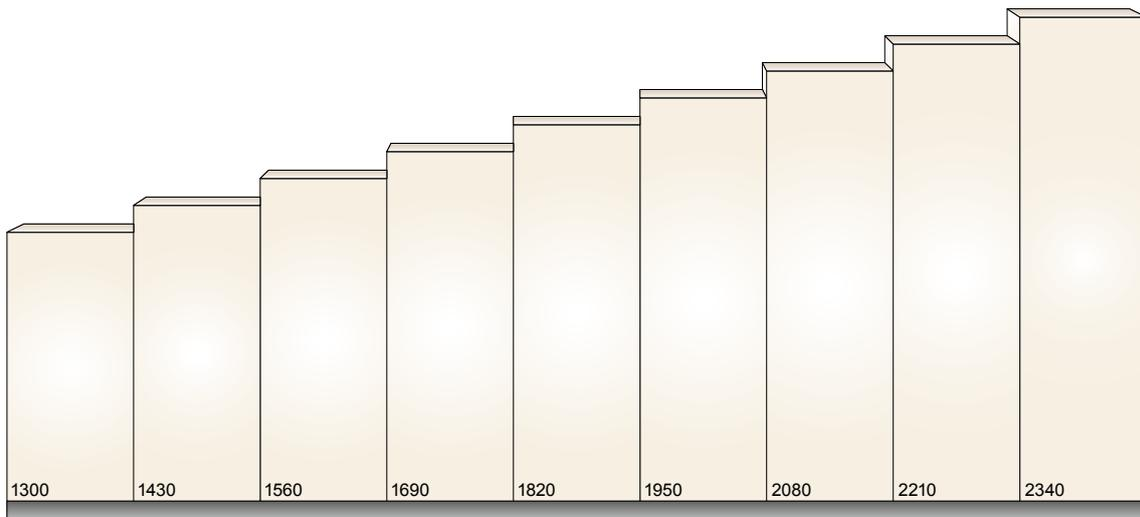

COMBINATION OF BASE, TALL AND WALL UNITS

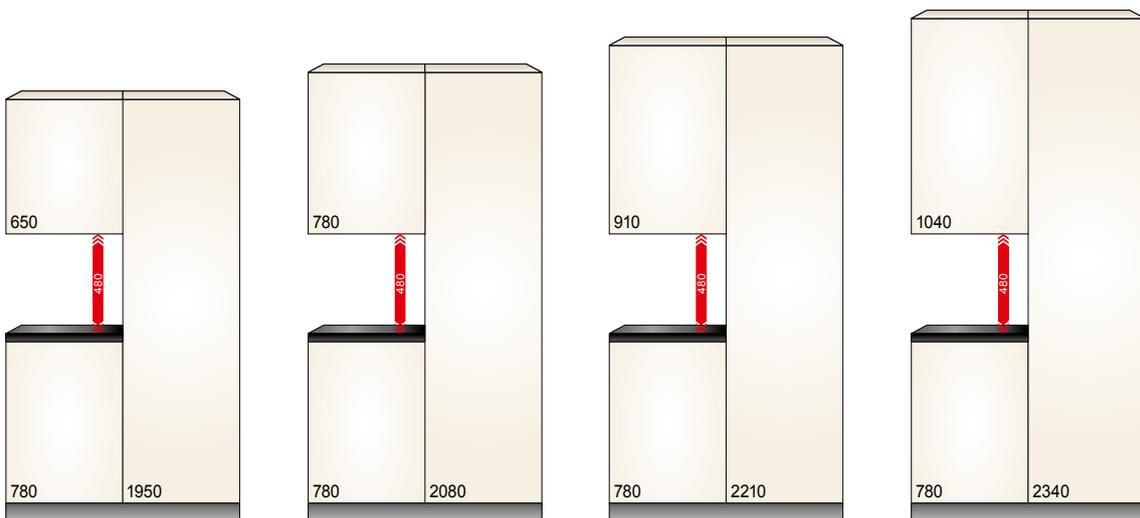

dimensions in mm

WALL UNITS

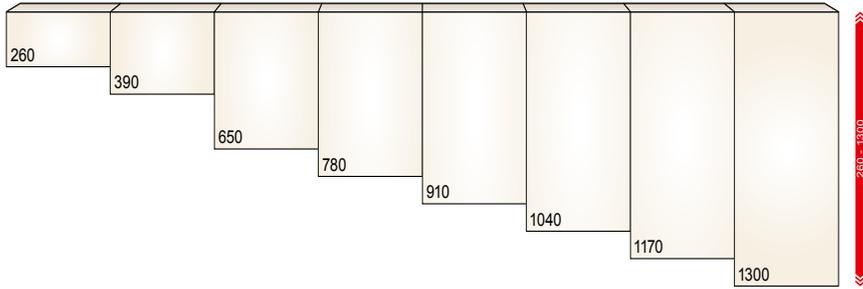

BASE UNITS

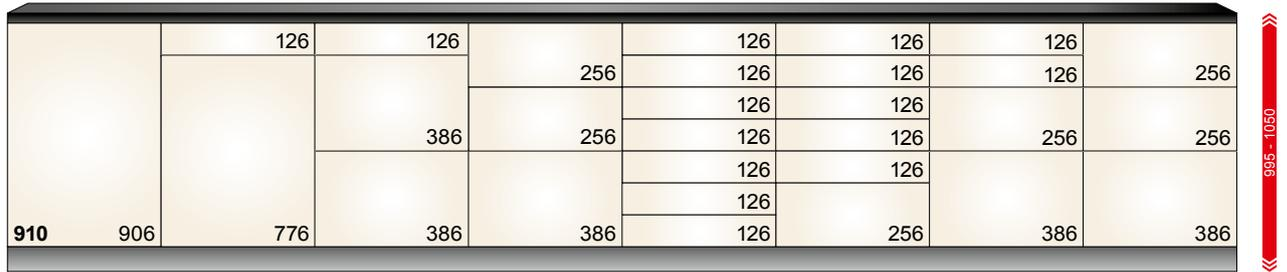

TALL UNITS

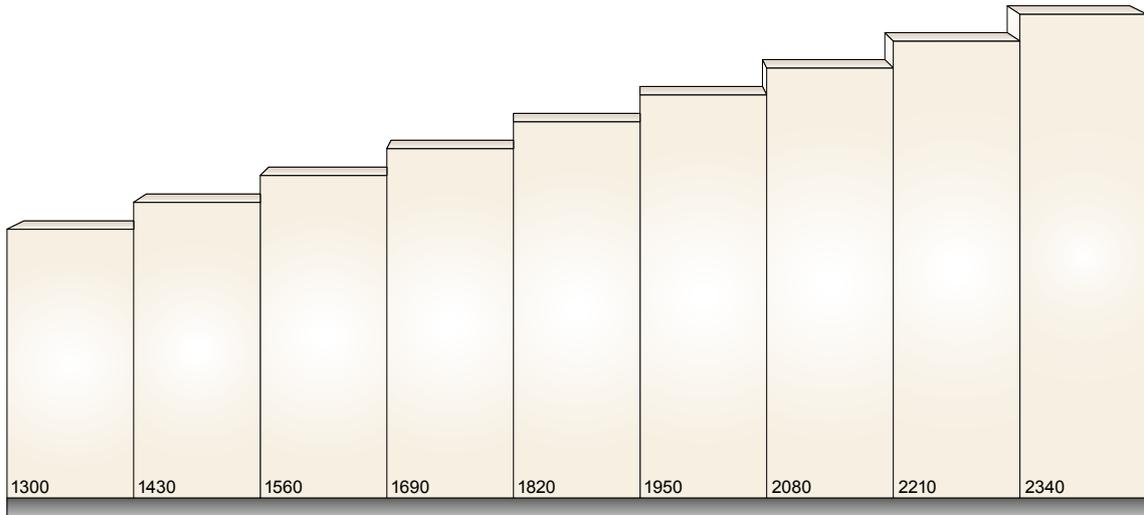

COMBINATION OF BASE, TALL AND WALL UNITS

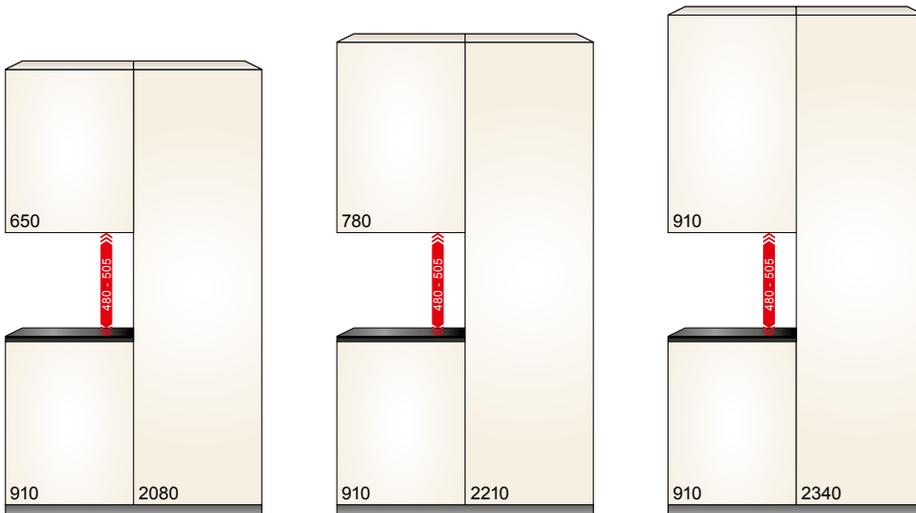

dimensions in mm

S 126 WALL UNITS

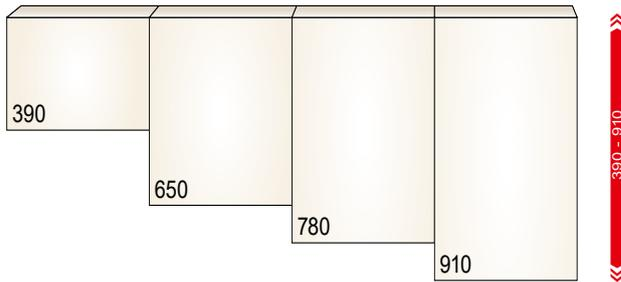

S 126 BASE UNITS

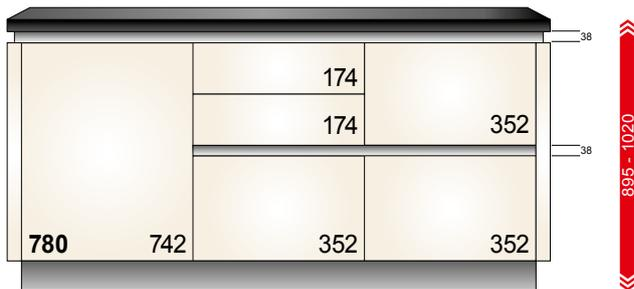

S 126 TALL UNITS

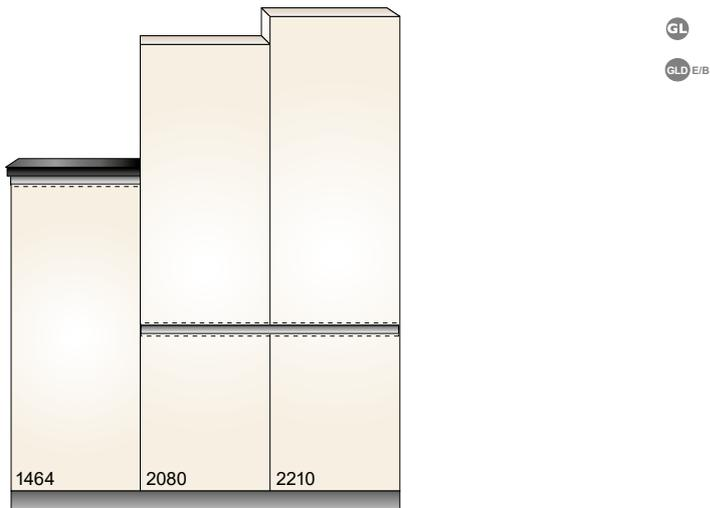

S 126 COMBINATION OF BASE, TALL AND WALL UNITS

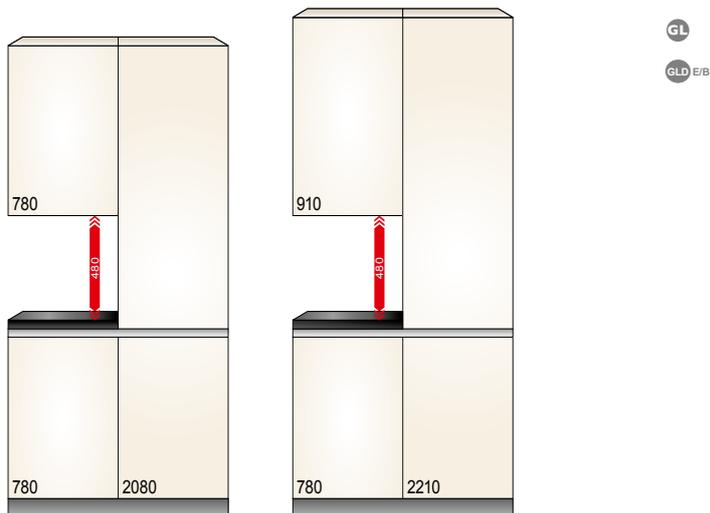

WALL UNITS

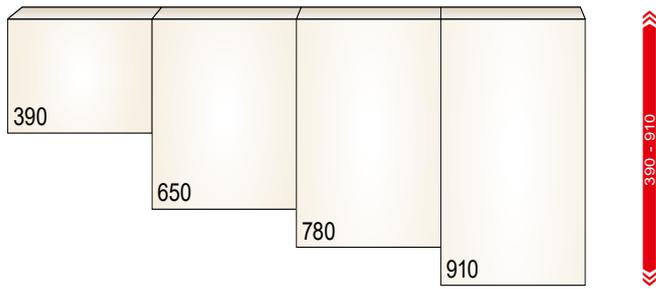

BASE UNITS

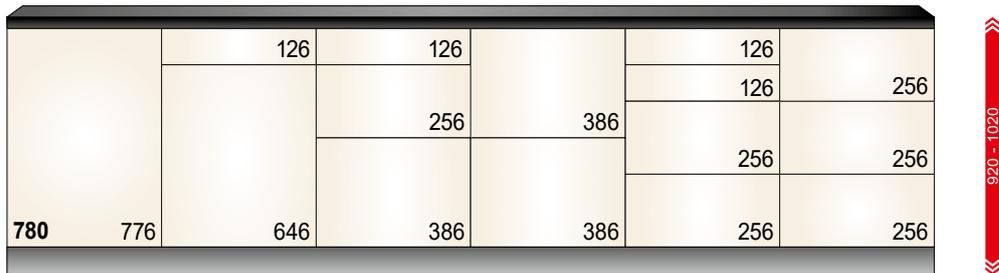

TALL UNITS

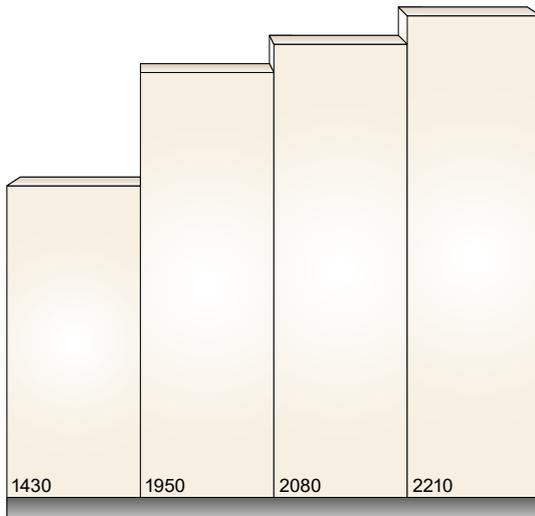

COMBINATION OF BASE, TALL AND WALL UNITS

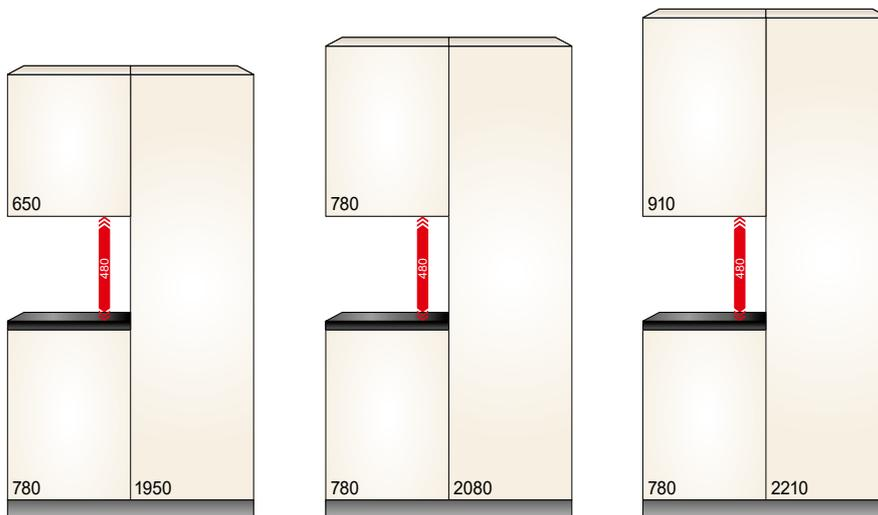

dimensions in mm

dimensions in mm

S 126 WALL UNITS

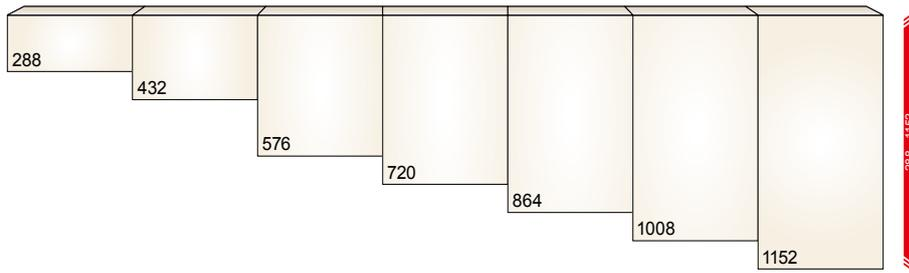

S 126 BASE UNITS

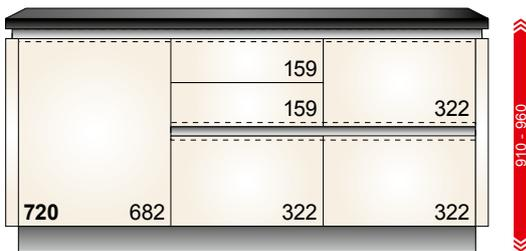

S 126 TALL UNITS

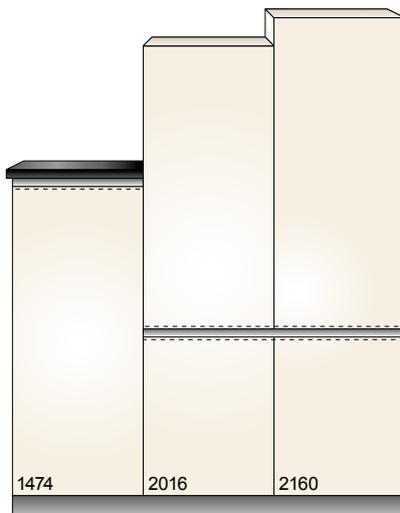

S 126 COMBINATION OF BASE, TALL AND WALL UNITS

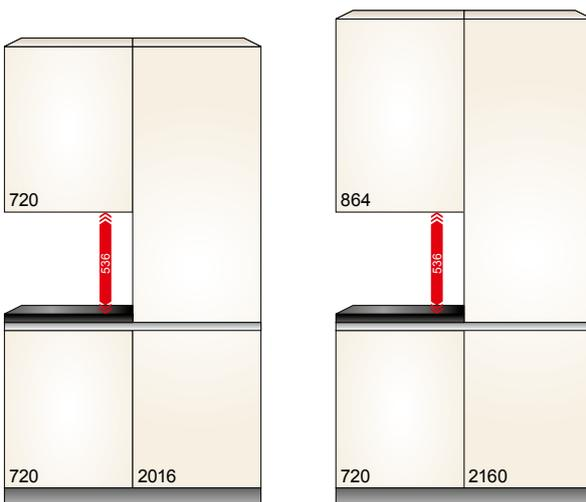

dimensions in mm

WALL UNITS

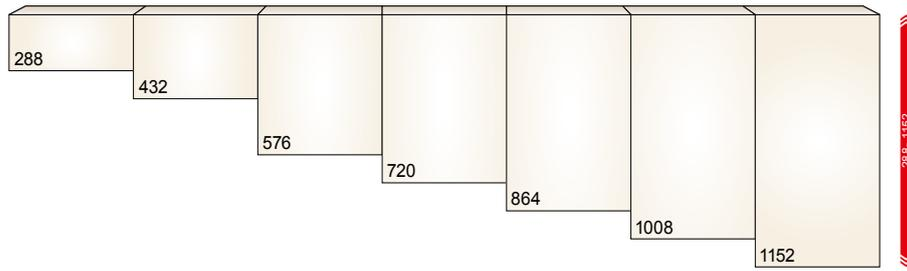

BASE UNITS

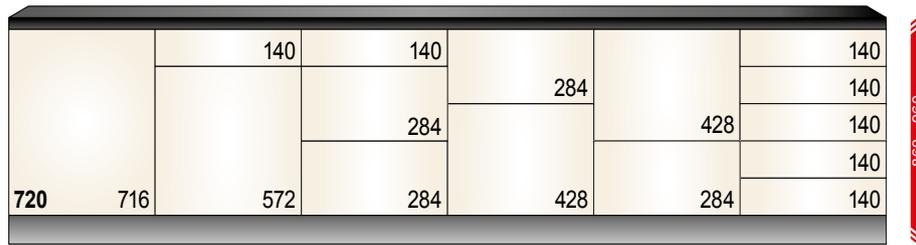

TALL UNITS

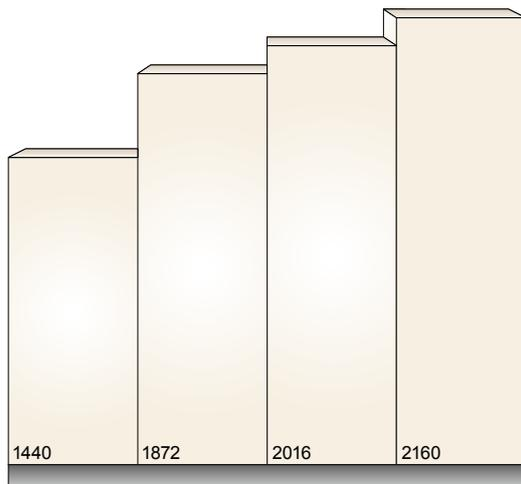

COMBINATION OF BASE, TALL AND WALL UNITS

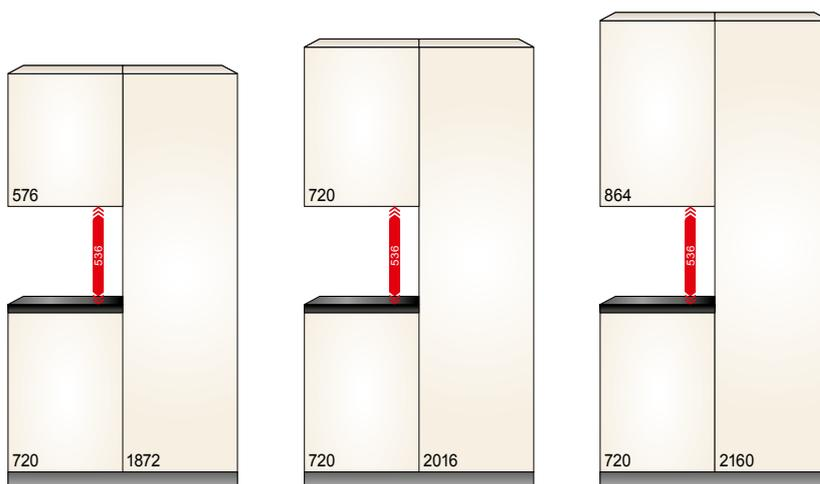

Universal glass doors

FRAME 20 MM	GLASS TYPES	ALU	INOX	SNOW	BLACK
		A20	I20	S20	B20
	Clear glass (KG)	*	*	*	*
	Matt satinato (SAT M)	*	*	*	*
	Shiny satinato (SAT G)	*	*	*	*
	Shiny black glass (SG G)	-	-	-	*

Aluminium frame **20 x 20** mm in the various colour options.
Frame only available with metal knob.

Please always specify the required glass type.

FRAME 50 MM	GLASS TYPES	ALU	INOX	SNOW	BLACK
		A50	I50	S50	B50
	Clear glass (KG)	*	*	*	*
	Matt satinato (SAT M)	*	*	*	*
	Shiny satinato (SAT G)	*	*	*	*
	Shiny black glass (SG G)	-	-	-	*

Polished aluminium frame **50 x 20** mm in the various colour options.
Frame only available with bar handle STG/STGE (extra charge applicable).

Please always specify the required glass type.

FRAME 55 MM	GLASS TYPES	INDUSTRY LOOK
		IL55
	Clear glass (KG)	*

Frame **55 x 20** mm in the industry look. The frame is always supplied without drilling.
Tip-On required (at extra charge).

FRAME 20 MM	GLASS TYPES	CROSSBAR DOOR
		SP20
	Clear glass (KG)	*

Frame **20 x 20** mm with crossbars, black lacquered aluminium. The frame can only be supplied with metal knob.

GLASS TYPES			
			
KG	SAT M	SAT G	SG G

KG Clear glass
SAT M Matt satinato
SAT G Shiny satinato
SG G Shiny black glass

Range-assigned glass doors

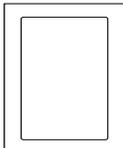
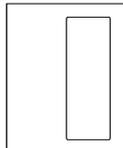
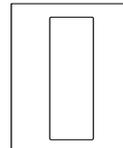
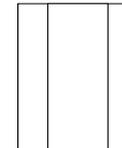
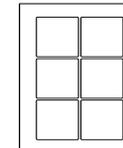
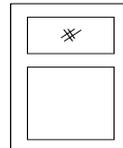
R	G*/GA*	GM	L	K	H
					
KG	KG	KG	KG	KG	KG
SAT M	SAT M	SAT M	SAT M	SAT M	SAT M
SAT G	SAT G	SAT G	SAT G	SAT G	SAT G
SG G	SG G	SG G	SG G	SG G	SG G

G* Glass element can be positioned either left or right.
Glass cut-out opposite the hinged side.

GA* Glass element can be positioned either left or right.
Glass cut-out opposite the hinged side.

GLASS TYPES			
			
KG	SAT M	SAT G	SG G

KG Clear glass
SAT M Matt satinato,
SAT G Shiny satinato
SG G Shiny black glass



- Elegant slim box system in the colour matt orion grey
- The drawer frames are absolutely straight inside and out, featuring 12.8 mm thick sides
- Metal back panel
- Undermounted runners
- High dynamic load-bearing capacity
40 kg up to 60 cm width
70 kg from a width of 80 cm upwards
- Smooth running action even when fully loaded
- Silent and effortless closing with integrated BLUMOTION
- Minimal sag due to the sturdy cabinet profile
- Colour-matched inner dividing system
- TIP-ON BLUMOTION available for LEGRABOX (mechanical one-touch opening for drawers and pull-outs)
- SERVO-DRIVE flex available for the electrical opening of handleless integrated fridges and dishwashers



Legrabox - Free
with 10 mm clear glass
(extra charge)



Screw-fastened 5 mm **MDF** back panel
19 mm solid wood crossmember in front

Standard carcass depth 575 mm,
550 mm optional at no extra charge

15 different carcass colours,
matching colour inside and out

Thin-walled LEGRABOX with under-
mounted runners and steel back panel

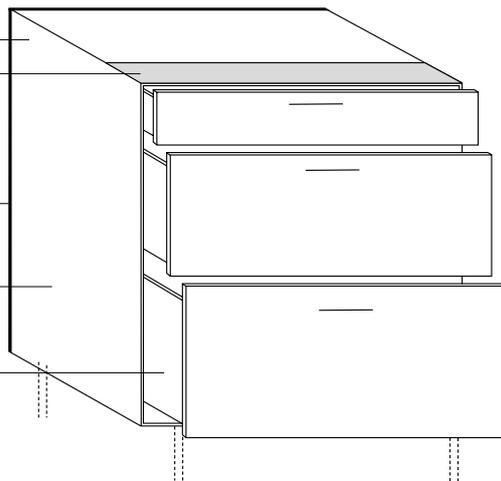

19 mm carcass

Concealed hanging brackets

Screw-fastened 5 mm **MDF** back panel

19 mm removable shelves with
securing pin

3 mm shelf supports

Blum all-metal hinges with integral damping
180° hinge with integral damping



[ELarge]

[XTend]

[←EWide→]



Larder units with full-height pull-out interior / LeMans units:
as standard with high-quality luxury chrome interior fittings



- new innovative drawer system in matt orion grey, recipient of the German Design Award 2020
- metal back panel
- exceptional stability thanks to the innovative L-shape of the cabinet profile
- high dynamic load-bearing capacity:
up to 60 cm wide with a load capacity of 40 kg
from 80 cm wide pull-outs with a load capacity of 70 kg
- high front stability
- colour-matched inner dividing system
- TIP-ON BLUMOTION available for MERIVOBX (mechanical one-touch opening for drawers and pull-outs)

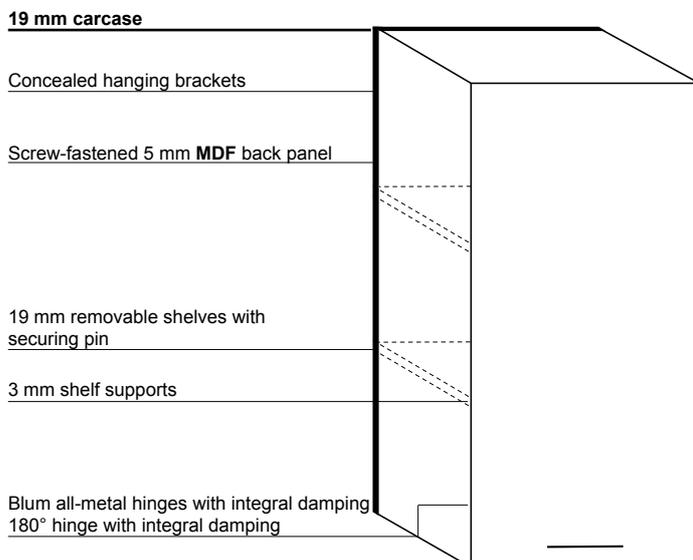
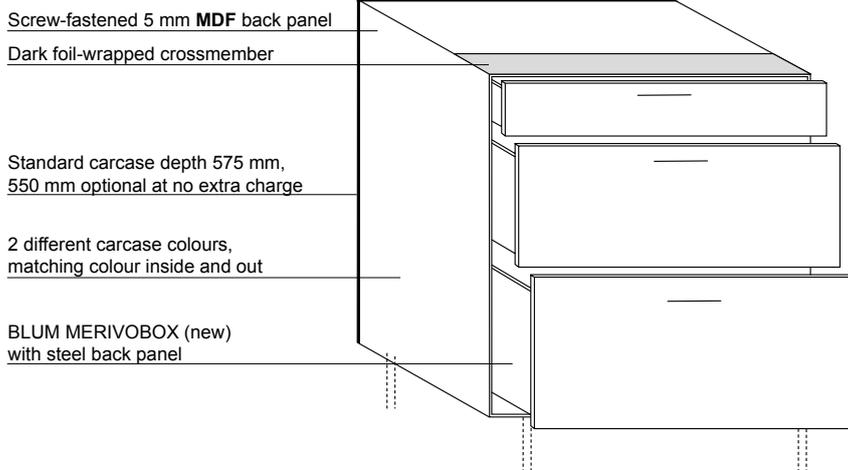

Larder units with full-height pull-out interior / LeMans units: as standard with graphite-coloured powder-coated interior fittings



- Blum TANDEMBOX plus system
- Fully extending pull-out and smooth gliding action under maximum load
- High-quality aluminium look, without glass sides
- up to 60 cm wide with 30 kg load-bearing capacity
- From 80 cm wide with 50 kg load-bearing capacity
- 3-way adjustment for front panels
- BLUMOTION - virtually silent closing even when fully loaded
- Lift-off protection

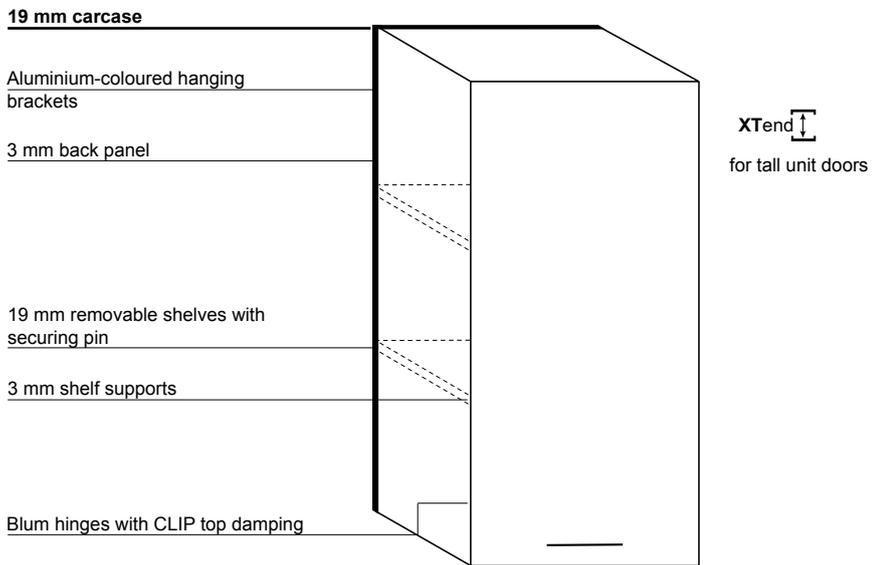
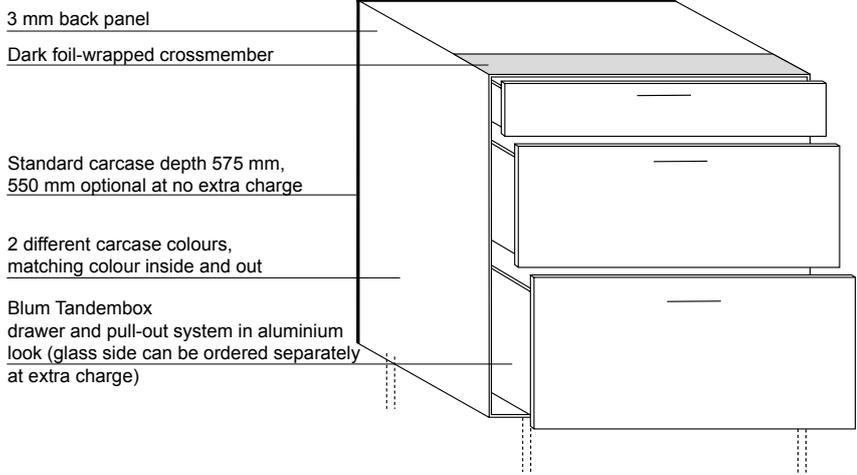

Melamine
fronts



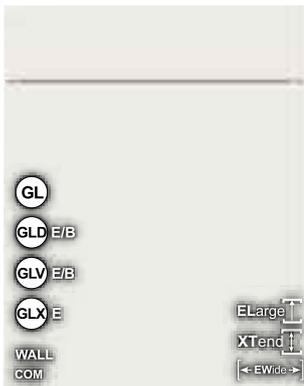

PREMIUM

Glass doors
G/GA/GM/R Framed glass door,
L Door with vertical side stiles

TOUCH	COM	Front colour	Carcase	Vis. side	W 19	W50+100	KL/LL	Plinth	Shelving
GLV 45 P108 006	P229 006	bianco	KS	UM	UM	UM W100	-	UM	UM
GLV 45 P108 063	P229 063	carbon	KS	-	KS	KS	-	KS	KS
GLV 45 P108 123	P229 123	dolphin	*	KS	KS	KS	-	KS	KS
GLV 45 P108 014	P229 014	fango	KS	-	KS	KS	-	KS	KS
GLV 45 P108 095	P229 095	grigio	KS	-	KS	KS	-	KS	KS
GLV 45 P108 024	P229 024	cashmere	KS	-	KS	KS	-	KS	KS
GLV 45 P108 064	P229 064	pebble-grey	KS	-	KS	KS	-	KS	KS
GLV 45 P108 090	P229 090	magnolia	KS	UM	UM	UM W100	-	UM	UM
P108 112	P229 112	moss	*	KS	KS	KS W100	-	KS	-
P108 013	P229 013	muscata	*	KS	KS	KS	-	KS	KS
P108 007	P229 007	optiwhite	KS	-	KS	KS	-	KS	KS
GLV 45 P108 126	P229 126	sharky	KS	-	KS	KS	-	KS	KS
GLV 45 P108 128	P229 128	slate	*	KS	KS	KS	-	KS	KS
GLV 45 P108 101	P229 101	snow	KS	UM	UM	UM W100	-	UM	UM



LITE

Glass doors
Only universal glass doors available

TOUCH	Front colour	Carcase	Vis. side	W 19	W50+100	KL/LL	Plinth	Shelving
L108 006	bianco	*	UM	UM	UM W100	-	UM	UM
L108 123	delphin	KS	-	KS	KS	-	KS	KS
L108 095	grigio	*	KS	KS	KS	-	KS	KS
L108 024	cashmere	*	KS	KS	KS	-	KS	KS
L108 064	pebble-grey	*	KS	KS	KS	-	KS	KS
L108 112	moss	*	KS	KS	KS W100	-	KS	-
L108 007	optiwhite	*	KS	KS	KS	-	KS	KS
L108 126	sharky	*	KS	KS	KS	-	KS	KS
L108 128	slate	KS	-	KS	KS	-	KS	KS
L108 101	snow	*	UM	UM	UM W100	-	UM	UM



NEW

Glass doors
R Framed glass door,
L Door with vertical side stiles

TOUCH	Front colour	Carcase	Vis. side	W 19	W50+100	KL/LL	Plinth	Shelving
N108 006	bianco	KS	UM	UM	-	-	UM	UM
N108 063	carbon	KS	-	KS	-	-	KS	KS
N108 014	fango	*	KS	KS	-	-	KS	KS
N108 095	grigio	*	KS	KS	-	-	KS	KS
N108 024	cashmere	*	KS	KS	-	-	KS	KS
N108 090	magnolia	*	UM	UM	-	-	UM	UM
N108 013	muscata	*	KS	KS	-	-	KS	KS



Front: Melamine with fine-matt (KS)/ ultra-matt (UM) surface and zero joint edge all around, reverse side in the same colour (the surface feel of the different colours varies slightly)

Handle drilling options

TOUCH

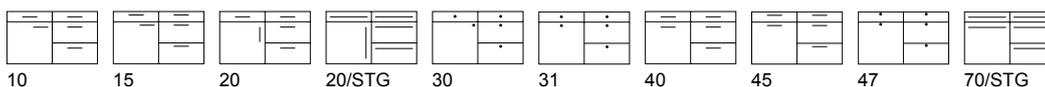



P R E M I U M

Glass doors

G/GA/GM/R Framed glass door,
L Door with vertical side stiles

PORTO H	COM	Front colour	Carcase	Vis. side	W 19	W50+100	KL/LL	Plinth	Shelving
P105 006	P250 006	bianco, H	KS	WL	WL	WL	-	WL	WL
P105 023	P250 023	denver-oak, H	*	WL	WL	WL W100	-	WL	-
P105 045	P250 045	oak bardolino, H	*	WL	WL	WL	-	WL	WL
P105 017	P250 017	graphite, H	KS	WL	WL	WL	-	WL	WL
P105 028	P250 028	nat. knotty oak, H	KS	-	WL	WL	-	WL	WL

PORTO V	COM	Front colour	Carcase	Vis. side	W 19	W50+100	KL/LL	Plinth	Shelving
P104 006	P249 006	bianco, V	KS	WL	WL	WL	-	WL	WL
P104 023	P249 023	denver-oak, V	*	WL	WL	WL W100	-	WL	-
P104 045	P249 045	oak bardolino, V	*	WL	WL	WL	-	WL	WL
P104 017	P249 017	graphite, V	KS	WL	WL	WL	-	WL	WL
P104 028	P249 028	nat. knotty oak, V	KS	-	WL	WL	-	WL	WL



L I T E

Glass doors

Only universal glass doors available

PORTO H	Front colour	Carcase	Vis. side	W 19	W50+100	KL/LL	Plinth	Shelving
L105 023	denver-oak, H	*	WL	WL	WL W100	-	WL	-
L105 045	oak bardolino, H	*	WL	WL	WL	-	WL	WL
L105 028	nat. knotty oak, H	*	WL	WL	WL	-	WL	WL

PORTO V	Front colour	Carcase	Vis. side	W 19	W50+100	KL/LL	Plinth	Shelving
L104 023	denver-oak, V	*	WL	WL	WL W100	-	WL	-
L104 045	oak bardolino, V	*	WL	WL	WL	-	WL	WL
L104 028	nat. knotty oak, V	*	WL	WL	WL	-	WL	WL



N E W

Glass doors

R Framed glass door,
L Door with vertical side stiles

PORTO H	Front colour	Carcase	Vis. side	W 19	W50+100	KL/LL	Plinth	Shelving
N105 006	bianco, H	KS	WL	WL	-	-	WL	WL
N105 017	graphite, H	*	WL	WL	-	-	WL	WL
N105 028	nat. knotty oak, H	*	WL	WL	-	-	WL	WL

PORTO V	Front colour	Carcase	Vis. side	W 19	W50+100	KL/LL	Plinth	Shelving
N104 006	bianco, V	KS	WL	WL	-	-	WL	WL
N104 017	graphite, V	*	WL	WL	-	-	WL	WL
N104 028	nat. knotty oak, V	*	WL	WL	-	-	WL	WL

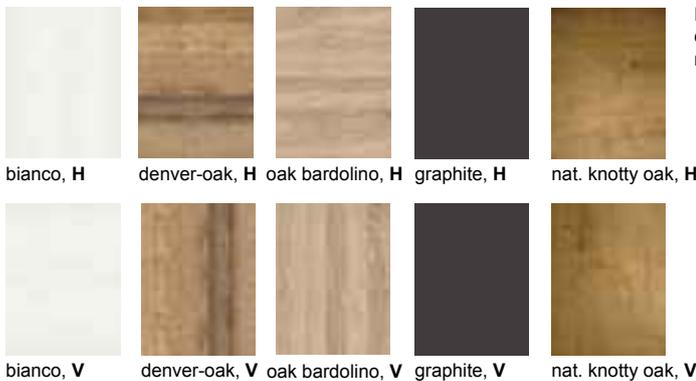

Front: Melamine, 0.8 mm edge all around, wood decor with **horizontally/vertically running** woodline surface, reverse side in the same colour

Handle drilling options

PORTO H+V woodline

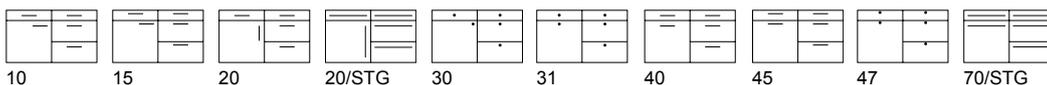

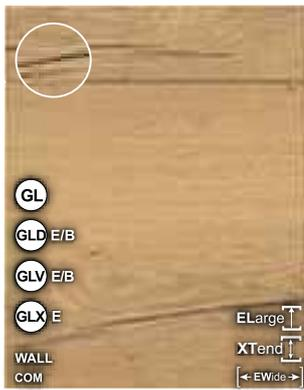

PREMIUM

Glass doors
G/GA/GM/R Framed glass door,
L Door with vertical side stiles

SINCRONO H	COM	Front colour	Carcase	Vis. side	W 19	W50+100	KL/LL	Plinth	Shelving
GLV)45 P114 200	P206 200	argento, H	*	ST	ST	ST	-	ST	ST
P114 116	P206 116	darkwood, H	*	WL	WL	WL W100	-	WL	WL
GLV)45 P114 199	P206 199	halifax crack oak, H	KS	-	ST	ST	-	ST	ST
GLV)45 P114 175	P206 175	halifax nature, H	*	ST	ST	ST	-	ST	ST
GLV)45 P114 145	P206 145	halifax white, H	*	ST	ST	ST	-	ST	ST
GLV)45 P114 115	P206 115	knotty oak, H	*	ST	ST	ST	-	ST	ST
GLV)45 P114 140	P206 140	nordic, H	*	WL	WL	WL	-	WL	WL
GLV)45 P114 046	P206 046	sanremo oak, H	*	WL	WL	WL	-	WL	WL
GLV)45 P114 117	P206 117	stormy oak, H	*	WL	WL	WL	-	WL	WL
SINCRONO V	COM	Front colour	Carcase	Vis. side	W 19	W50+100	KL/LL	Plinth	Shelving
GLV)45 P115 200	P207 200	argento, V	*	ST	ST	ST	-	ST	ST
P115 116	P207 116	darkwood, V	*	WL	WL	WL W100	-	WL	WL
GLV)45 P115 199	P207 199	halifax crack oak, V	KS	-	ST	ST	-	ST	ST
GLV)45 P115 175	P207 175	halifax nature, V	*	ST	ST	ST	-	ST	ST
GLV)45 P115 145	P207 145	halifax white, V	*	ST	ST	ST	-	ST	ST
GLV)45 P115 115	P207 115	knotty oak, V	*	ST	ST	ST	-	ST	ST
GLV)45 P115 140	P207 140	nordic, V	*	WL	WL	WL	-	WL	WL
GLV)45 P115 046	P207 046	sanremo oak, V	*	WL	WL	WL	-	WL	WL
GLV)45 P115 117	P207 117	stormy oak, V	*	WL	WL	WL	-	WL	WL



LITE

Glass doors
Only universal glass doors available

SINCRONO H	Front colour	Carcase	Vis. side	W 19	W50+100	KL/LL	Plinth	Shelving
L114 200	argento, H	*	ST	ST	ST	-	ST	ST
L114 175	halifax nature, H	*	ST	ST	ST	-	ST	ST
L114 145	halifax white, H	*	ST	ST	ST	-	ST	ST
L114 115	knotty oak, H	*	ST	ST	ST	-	ST	ST
L114 046	sanremo oak, H	*	WL	WL	WL	-	WL	WL
L114 117	stormy oak, H	*	WL	WL	WL	-	WL	WL

SINCRONO V	Front colour	Carcase	Vis. side	W 19	W50+100	KL/LL	Plinth	Shelving
L115 200	argento, H	*	ST	ST	ST	-	ST	ST
L115 175	halifax nature, V	*	ST	ST	ST	-	ST	ST
L115 145	halifax white, V	*	ST	ST	ST	-	ST	ST
L115 115	knotty oak, V	*	ST	ST	ST	-	ST	ST
L115 046	sanremo oak, V	*	WL	WL	WL	-	WL	WL
L115 117	stormy oak, V	*	WL	WL	WL	-	WL	WL



NEW

Glass doors
R Framed glass door, L Door with vertical side stiles

SINCRONO H	Front colour	Carcase	Vis. side	W 19	W50+100	KL/LL	Plinth	Shelving
N114 145	halifax white, H	*	ST	ST	-	-	ST	ST
N114 140	nordic, H	*	WL	WL	-	-	WL	WL
N114 046	sanremo oak, H	*	WL	WL	-	-	WL	WL

SINCRONO V	Front colour	Carcase	Vis. side	W 19	W50+100	KL/LL	Plinth	Shelving
N115 145	halifax white, V	*	ST	ST	-	-	ST	ST
N115 140	nordic, V	*	WL	WL	-	-	WL	WL
N115 046	sanremo oak, V	*	WL	WL	-	-	WL	WL



Front: Melamine with synchronized pore finish and **horizontally/vertically running** grain, matching edge, reverse side in the same colour



Handle drilling options SINCRONO H+V

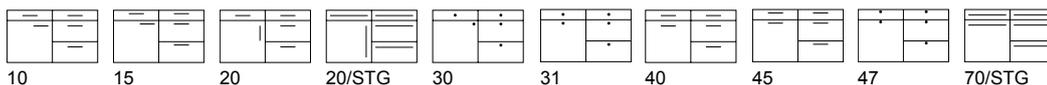

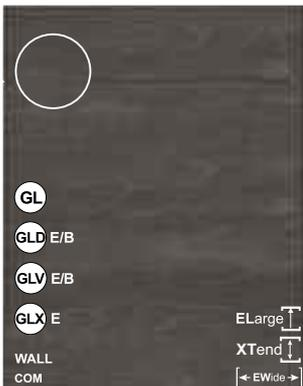

PREMIUM

Glass doors

G/GA/GM/R Framed glass door,
L Door with vertical side stiles

SHERWOOD H		COM	Front colour	Carcase	Vis. side	W 19	W 100	KL/LL	Plinth	Shelving
GLV 45	P140 122	P290 122	black, H	KS	ST	ST	ST	-	ST	ST
	P140 198	P290 198	burned wood, H	*	ST	ST	ST	-	ST	-
GLV 45	P140 142	P290 142	bushy park, H	*	ST	ST	ST	-	ST	ST
GLV 45	P140 092	P290 092	cigar, H	*	ST	ST	ST	-	ST	ST
GLV 45	P140 093	P290 093	engadina, H	*	ST	ST	ST	-	ST	ST
	P140 203	P290 203	graphite, H	KS	ST	ST	ST	-	ST	ST
GLV 45	P140 144	P290 144	greenwich, H	*	ST	ST	ST	-	ST	ST
GLV 45	P140 195	P290 195	nature, H	*	ST	ST	ST	-	ST	ST
GLV 45	P140 143	P290 143	richmond, H	*	ST	ST	ST	-	ST	ST

SHERWOOD V		COM	Front colour	Carcase	Vis. side	W 19	W 100	KL/LL	Plinth	Shelving
GLV 45	P141 122	P291 122	black, V	KS	ST	ST	ST	-	ST	ST
	P141 198	P291 198	burned wood, V	*	ST	ST	ST	-	ST	-
GLV 45	P141 142	P291 142	bushy park, V	*	ST	ST	ST	-	ST	ST
GLV 45	P141 092	P291 092	cigar, V	*	ST	ST	ST	-	ST	ST
GLV 45	P141 093	P291 093	engadina, V	*	ST	ST	ST	-	ST	ST
	P141 203	P291 203	graphite, V	KS	ST	ST	ST	-	ST	ST
GLV 45	P141 144	P291 144	greenwich, V	*	ST	ST	ST	-	ST	ST
GLV 45	P141 195	P291 195	nature, V	*	ST	ST	ST	-	ST	ST
GLV 45	P141 143	P291 143	richmond, V	*	ST	ST	ST	-	ST	ST



LITE

Glass doors

Only universal glass doors available

SHERWOOD H	Front colour	Carcase	Vis. side	W 19	W 100	KL/LL	Plinth	Shelving
L140 198	burned wood, H	*	ST	ST	ST	-	ST	-
L140 142	bushy park, H	*	ST	ST	ST	-	ST	ST
L140 093	engadina, H	*	ST	ST	ST	-	ST	ST
L140 203	graphite, H	*	ST	ST	ST	-	ST	ST
L140 195	nature, H	*	ST	ST	ST	-	ST	ST

SHERWOOD V	Front colour	Carcase	Vis. side	W 19	W 100	KL/LL	Plinth	Shelving
L141 198	burned wood, V	*	ST	ST	ST	-	ST	-
L141 142	bushy park, V	*	ST	ST	ST	-	ST	ST
L141 093	engadina, V	*	ST	ST	ST	-	ST	ST
L141 203	graphite, V	*	ST	ST	ST	-	ST	ST
L141 195	nature, V	*	ST	ST	ST	-	ST	ST

Front: Thick-film melamine with deep synchronized pore finish and **horizontally/vertically running grain**, 1.0 mm PP edge all around, reverse side in the same colour

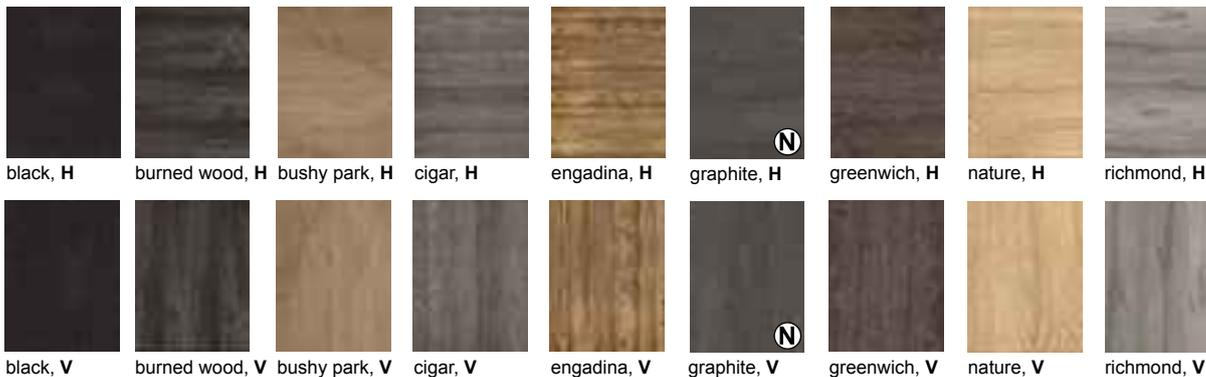

Handle drilling options SHERWOOD H+V

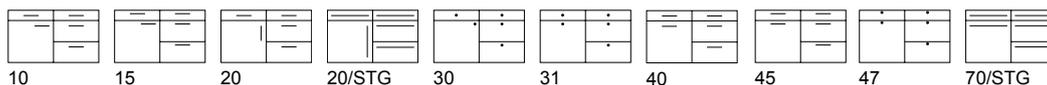

Melamine fronts
Matt-Line
High-gloss Line
Foil-wrapped fronts
Wood
Oak-Line
Handles, worktops decors, colour charts and discontinued lines



**P
R
E
M
I
U
M**

EDGE H	COM	Edge colour / Front colour	Carcase	Vis. side	W 19	W 100	KL/LL	Plinth	Shelving
P288 233	P325 233	black / halifax nature, H	*	ST	ST/EST	ST	-	ST	ST
P288 234	P325 234	snow / halifax nature, H	*	ST	ST/EST	ST	-	ST	ST
P288 235	P325 235	black / knotty oak, H	*	ST	ST/EST	ST	-	ST	ST
P288 236	P325 236	snow / knotty oak, H	*	ST	ST/EST	ST	-	ST	ST

EDGE V	COM	Edge colour / Front colour	Carcase	Vis. side	W 19	W 100	KL/LL	Plinth	Shelving
P298 233	P327 233	black / halifax nature, V	*	ST	ST/EST	ST	-	ST	ST
P298 234	P327 234	snow / halifax nature, V	*	ST	ST/EST	ST	-	ST	ST
P298 235	P327 235	black / knotty oak, V	*	ST	ST/EST	ST	-	ST	ST
P298 236	P327 236	snow / knotty oak V	*	ST	ST/EST	ST	-	ST	ST

Side panels **W19** are supplied in ST with same-coloured edge, in the EST model with a choice of black or snow edge, in line with the range.

Glass doors
G/GA/GM/R Framed glass door,
L Door with vertical side stiles

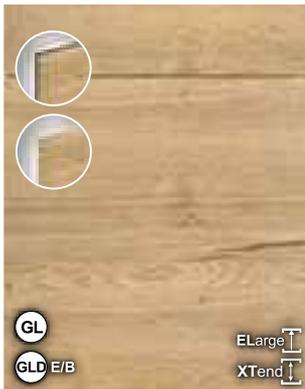

**L
I
T
E**

EDGE H	Edge colour / Front colour	Carcase	Vis. side	W 19	W 100	KL/LL	Plinth	Shelving
L288 233	black / halifax nature, H	*	ST	ST/EST	ST	-	ST	ST
L288 234	snow / halifax nature, H	*	ST	ST/EST	ST	-	ST	ST
L288 235	black / knotty oak, H	*	ST	ST/EST	ST	-	ST	ST
L288 236	snow / knotty oak, H	*	ST	ST/EST	ST	-	ST	ST

EDGE V	Edge colour / Front colour	Carcase	Vis. side	W 19	W 100	KL/LL	Plinth	Shelving
L298 233	black / halifax nature, V	*	ST	ST/EST	ST	-	ST	ST
L298 234	snow / halifax nature, V	*	ST	ST/EST	ST	-	ST	ST
L298 235	black / knotty oak, V	*	ST	ST/EST	ST	-	ST	ST
L298 236	snow / knotty oak V	*	ST	ST/EST	ST	-	ST	ST

Side panels **W19** are supplied in ST with same-coloured edge, in the EST model with a choice of black or snow edge, in line with the range.

Glass doors
Only universal glass doors available



halifax nature, **H** knotty oak, **H**



halifax nature, **V** knotty oak, **V**

Front: Sincrono (H/V) front with a choice of matt edge in **black** or **snow** all around the door.
Decor pattern horizontal/vertical, reverse side in the same colour.

Handle drilling options EDGE H+V

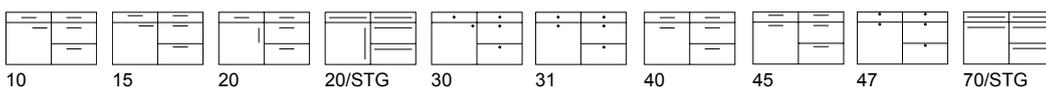



**P
R
E
M
I
U
M**

EDGE H	COM	Edge colour / Front colour	Carcase	Vis. side	W 19	W 100	KL/LL	Plinth	Shelving
P284 237	P335 237	black / engadina, H	*	ST	ST/EST	ST	-	ST	ST
P284 238	P335 238	snow / engadina, H	*	ST	ST/EST	ST	-	ST	ST
P284 239	P335 239	black / nature, H	*	ST	ST/EST	ST	-	ST	ST
P284 240	P335 240	snow / nature, H	*	ST	ST/EST	ST	-	ST	ST

EDGE V	COM	Edge colour / Front colour	Carcase	Vis. side	W 19	W 100	KL/LL	Plinth	Shelving
P296 237	P337 237	black / engadina, V	*	ST	ST/EST	ST	-	ST	ST
P296 238	P337 238	snow / engadina, V	*	ST	ST/EST	ST	-	ST	ST
P296 239	P337 239	black / nature, V	*	ST	ST/EST	ST	-	ST	ST
P296 240	P337 240	snow / nature, V	*	ST	ST/EST	ST	-	ST	ST

Side panels **W19** are supplied in ST with same-coloured edge, in the EST model with a choice of black or snow edge, in line with the range.

Glass doors

G/GA/GM/R framed glass door, L door with vertical side stiles

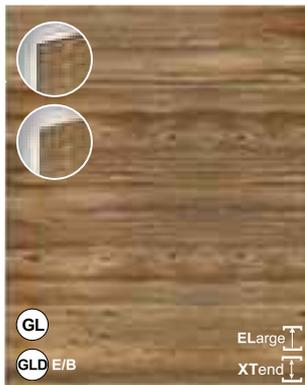

**L
I
T
E**

EDGE H	Edge colour / Front colour	Carcase	Vis. side	W 19	W 100	KL/LL	Plinth	Shelving
L284 237	black / engadina, H	*	ST	ST/EST	ST	-	ST	ST
L284 238	snow / engadina, H	*	ST	ST/EST	ST	-	ST	ST
L284 239	black / nature, H	*	ST	ST/EST	ST	-	ST	ST
L284 240	snow / nature, H	*	ST	ST/EST	ST	-	ST	ST

EDGE V	Edge colour / Front colour	Carcase	Vis. side	W 19	W 100	KL/LL	Plinth	Shelving
L296 237	black / engadina, V	*	ST	ST/EST	ST	-	ST	ST
L296 238	snow / engadina, V	*	ST	ST/EST	ST	-	ST	ST
L296 239	black / nature, V	*	ST	ST/EST	ST	-	ST	ST
L296 240	snow / nature, V	*	ST	ST/EST	ST	-	ST	ST

Side panels **W19** are supplied in ST with same-coloured edge, in the EST model with a choice of black or snow edge, in line with the range.

Glass doors

Only universal glass doors available



Front: Sherwood (H/V) front with a choice of matt edge in black or snow all around the door. Decor pattern horizontal/vertical, reverse side in same colour.

Handle drilling options

EDGE H+V

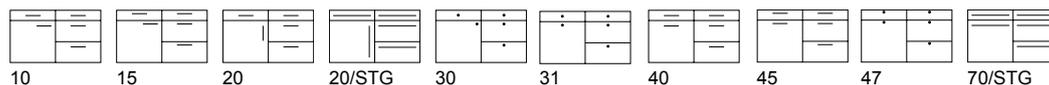



PREMIUM

Glass doors

G/GA/GM/R Framed glass door,
L Door with vertical side stiles

SMART H COM	Front colour	Carcase	Vis. side	W 19	W50+100	KL/LL	Plinth	Shelving
P148 153 P279 153	vic. oak claire, H	KS	-	WL	WL	-	WL	WL

SMART V COM	Front colour	Carcase	Vis. side	W 19	W50+100	KL/LL	Plinth	Shelving
P149 153 P280 153	vic. oak claire, V	KS	-	WL	WL	-	WL	WL



LITE

Glass doors

Only universal glass doors available

SMART H	Front colour	Carcase	Vis. side	W 19	W50+100	KL/LL	Plinth	Shelving
L148 153	vic. oak claire, H	*	WL	WL	WL	-	WL	WL

SMART V	Front colour	Carcase	Vis. side	W 19	W50+100	KL/LL	Plinth	Shelving
L149 153	vic. oak claire, V	*	WL	WL	WL	-	WL	WL



NEW

Glass doors

R Framed glass door,
L Door with vertical side stiles

SMART H	Front colour	Carcase	Vis. side	W 19	W50+100	KL/LL	Plinth	Shelving
N148 153	vic. oak claire, H	*	WL	WL	-	-	WL	WL

SMART V	Front colour	Carcase	Vis. side	W 19	W50+100	KL/LL	Plinth	Shelving
N149 153	vic. oak claire, V	*	WL	WL	-	-	WL	WL



vic. oak claire, H

Front: Melamine with fine **horizontally/vertically running** wood graining and PP edge, reverse side in the same decor



vic. oak claire, V

Handle drilling options

SMART H+V

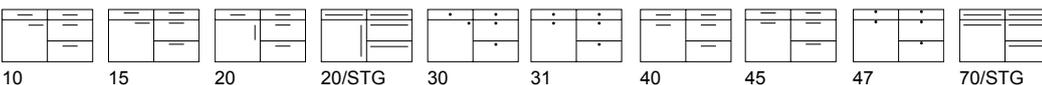

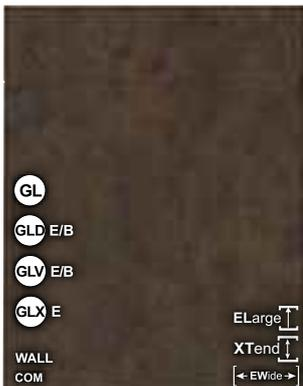

Glass doors

G/GA/GM/R Framed glass door,
L Door with vertical side stiles

	CEMENTO	COM	Front colour	Carcase	Vis. side	W 19	W 100	KL/LL	Plinth	Shelving
GLV 45	P170 205	P270 205	amber	*	ST	ST	ST	-	ST	ST
GLV 45	P170 096	P270 096	basalt dunkel	*	ST	ST	ST	-	ST	ST
GLV 45	P170 022	P270 022	black	KS	ST	ST	ST	-	ST	ST
	P170 039	P270 039	bronze	*	ST	ST	ST	-	ST	ST
	P170 040	P270 040	light grey	*	ST	ST	ST	-	ST	ST
GLV 45	P170 097	P270 097	light oxide	*	ST	ST	ST	-	ST	ST
GLV 45	P170 118	P270 118	steel blue	*	ST	ST	ST	-	ST	ST



Glass doors

Only universal glass doors available

	CEMENTO	Front colour	Carcase	Vis. side	W 19	W 100	KL/LL	Plinth	Shelving
	L170 205	amber	*	ST	ST	ST	-	ST	ST
	L170 096	basalt dunkel	*	ST	ST	ST	-	ST	ST
	L170 040	light grey	*	ST	ST	ST	-	ST	ST
	L170 097	light oxide	*	ST	ST	ST	-	ST	ST
	L170 118	steel blue	*	ST	ST	ST	-	ST	ST



Glass doors

R Framed glass door,
L Door with vertical side stiles

	CEMENTO	Front colour	Carcase	Vis. side	W 19	W 100	KL/LL	Plinth	Shelving
	N170 096	basalt dunkel	*	ST	ST	-	-	ST	ST
	N170 040	light grey	*	ST	ST	-	-	ST	ST
	N170 097	light oxide	*	ST	ST	-	-	ST	ST

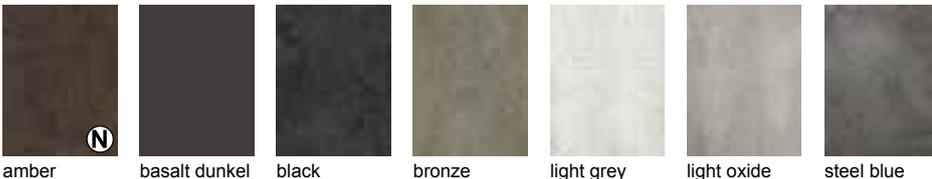

Front: Thick-film melamine with concrete texture and feel, 1.0 mm PP edge all around, reverse side in the same colour

Handle drilling options

CEMENTO

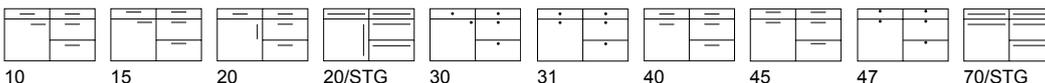

Melamine fronts
Matt-Line
High-gloss Line
Foil-wrapped fronts
Wood
Oak-Line
Handles, worktops decors, colour charts and discontinued lines

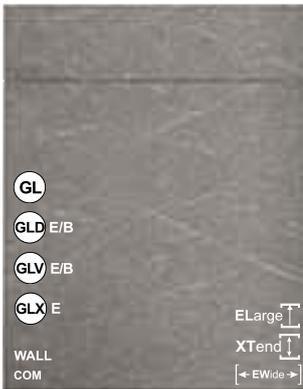

PREMIUM

Glass doors
G/GA/GM/R Framed glass door,
L Door with vertical side stiles

RUPE H	COM	Front colour	Carcase	Vis. side	W 19	W 100	KL/LL	Plinth	Shelving
P204 119	P304 119	ash, H	*	ST	ST	ST	-	ST	ST
P204 120	P304 120	sand, H	*	ST	ST	ST	-	ST	ST

RUPE V	COM	Front colour	Carcase	Vis. side	W 19	W 100	KL/LL	Plinth	Shelving
P205 119	P308 119	ash, V	*	ST	ST	ST	-	ST	ST
P205 120	P308 120	sand, V	*	ST	ST	ST	-	ST	ST

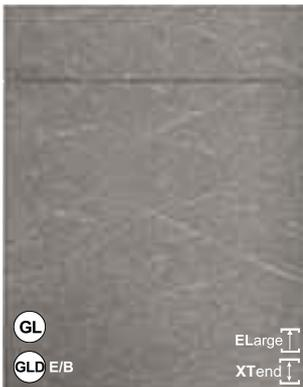

LITE

Glass doors
Only universal glass doors available

RUPE H	Front colour	Carcase	Vis. side	W 19	W 100	KL/LL	Plinth	Shelving
L204 119	ash, H	*	ST	ST	ST	-	ST	ST
L204 120	sand, H	*	ST	ST	ST	-	ST	ST

RUPE V	Front colour	Carcase	Vis. side	W 19	W 100	KL/LL	Plinth	Shelving
L205 119	ash, V	*	ST	ST	ST	-	ST	ST
L205 120	sand, V	*	ST	ST	ST	-	ST	ST



ash, H sand, H



ash, V sand, V

Front: Thick-film melamine with stone feel and **horizontally/vertically running** grain, 1.0 mm PP edge all around, reverse side in the same colour

Handle drilling options RUPE H+V

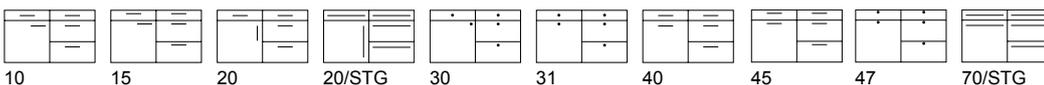

METALL H/V

COM

Melamine

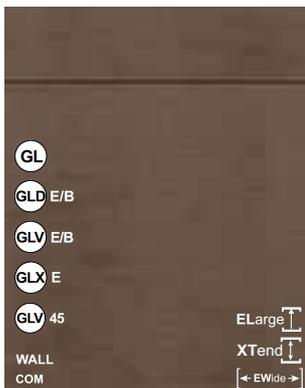

PREMIUM

Glass doors

G/GA/GM/R Framed glass door,
L Door with vertical side stiles

METALL H	COM	Front colour	Carcase	Vis. side	W 19	W 100	KL/LL	Plinth	Shelving
P233 022	P333 022	black, H	KS	ST	ST	ST	-	ST	ST
P233 196	P333 196	brown, H	*	ST	ST	ST	-	ST	ST
P233 060	P333 060	dark steel, H	*	ST	ST	ST	-	ST	ST
P233 059	P333 059	light umbra, H	*	ST	ST	ST	-	ST	ST

METALL V	COM	Front colour	Carcase	Vis. side	W 19	W 100	KL/LL	Plinth	Shelving
P234 022	P334 022	black, V	KS	ST	ST	ST	-	ST	ST
P234 196	P334 196	brown, V	*	ST	ST	ST	-	ST	ST
P234 060	P334 060	dark steel, V	*	ST	ST	ST	-	ST	ST
P234 059	P334 059	light umbra, V	*	ST	ST	ST	-	ST	ST

Melamine fronts

Matt-Line

High-gloss Line

Foil-wrapped fronts

Wood

Oak-Line

Handles, worktops decors, colour charts and discontinued lines

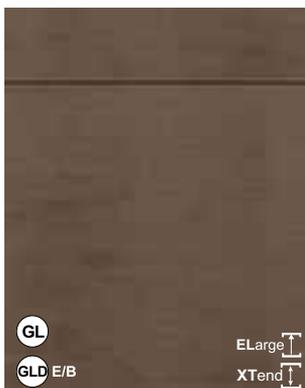

LITE

Glass doors

Only universal glass doors available

METALL H	Front colour	Carcase	Vis. side	W 19	W 100	KL/LL	Plinth	Shelving
L233 022	black, H	*	ST	ST	ST	-	ST	ST
L233 196	brown, H	*	ST	ST	ST	-	ST	ST
L233 060	dark steel, H	*	ST	ST	ST	-	ST	ST
L233 059	light umbra, H	*	ST	ST	ST	-	ST	ST

METALL V	Front colour	Carcase	Vis. side	W 19	W 100	KL/LL	Plinth	Shelving
L234 022	black, V	*	ST	ST	ST	-	ST	ST
L234 196	brown, V	*	ST	ST	ST	-	ST	ST
L234 060	dark steel, V	*	ST	ST	ST	-	ST	ST
L234 059	light umbra, V	*	ST	ST	ST	-	ST	ST



black, H brown, H dark steel, H light umbra, H



black, V brown, V dark steel, V light umbra, V

Front: Thick-film melamine, textured metal effect with **horizontally/vertically running** pattern, 1.0 mm PP edge all around, reverse side identical

Handle drilling options

METALL H+V

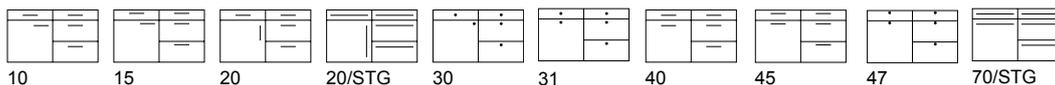



PREMIUM

CROSS	COM	Front colour	Carcase	Vis. side	W 19	W 100	KL/LL	Plinth	Shelving
P145 167	P245 167	reno	*	ST	ST	ST	-	ST	-

Glass doors

L Door with vertical side stiles



reno

Front: Thick-film melamine with textured metal effect, all-round edge in matching decor, reverse side in the same colour

Handle drilling options

CROSS

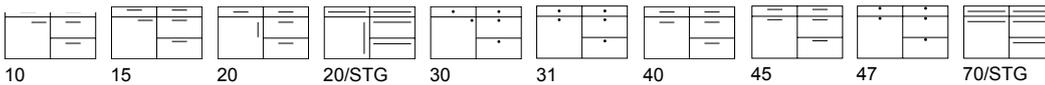

STYLE

KS/XTR/SMF

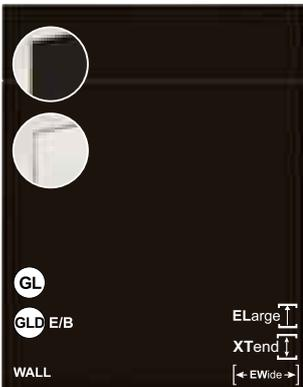

PREMIUM

			Front colour	Carcase	Vis. side	W 19	W50+100	KL/LL	Plinth	Shelving
P150 401	STYLE		Touch optiwhite	KS	-	KS STKS	KS	-	KS	KS
P275 402	STYLE		Extrem black	KS	XTR	XTR STXTR	XTR	-	XTR	KS
P275 403	STYLE		Extrem optiwhite	KS	XTR	XTR STXTR	XTR	-	XTR	KS
P355 404	STYLE		Fenix black	KS	SMF	SMF STSMF	SMF	-	SMF	KS
P355 405	STYLE		Fenix optiwhite	KS	SMF	SMF STSMF	SMF	-	SMF	KS

Glass doors

Only universal glass doors available

Touch

Extrem

Fenix



STYLE TOUCH optiwhite



STYLE EXTREM optiwhite



STYLE EXTREM black



STYLE FENIX optiwhite



STYLE FENIX black

Front: Above models with all-round compact-style edge, **W19 panels available with same-coloured edge** in KS/XTR/SMF or with **compact-style edge (STY)**, see table

Handle drilling options

STYLE

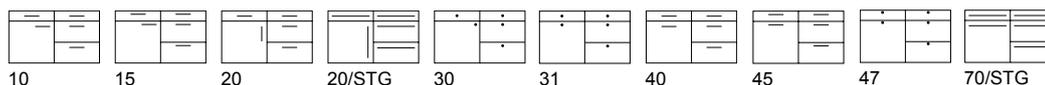

Matt-Line



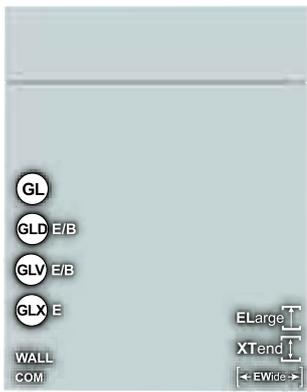

Glass doors
L Door with vertical side stiles

OPACO	COM	Front colour	Carcase	Vis. side	W 19	W50+100	KL/LL	Plinth	Shelving
P232 076	P332 076	anthracite	*	UVM	UVM	-	-	UVM	-
P232 250	P332 250	aqua	*	UVM	UVM	-	-	UVM	-
P232 006	P332 006	bianco	KS	UVM	UVM	-	-	UVM	KS
P232 022	P332 022	black	KS	UVM	UVM	-	-	UVM	KS
P232 063	P332 063	carbon	KS	UVM	UVM	-	-	UVM	KS
P232 129	P332 129	crush gold	*	UVM	UVM	-	-	UVM	-
P232 123	P332 123	dolphin	*	UVM	UVM	-	-	UVM	KS
P232 014	P332 014	fango	KS	UVM	UVM	-	-	UVM	KS
P232 024	P332 024	cashmere	KS	UVM	UVM	-	-	UVM	KS
P232 064	P332 064	pebble-grey	KS	UVM	UVM	-	-	UVM	KS
P232 251	P332 251	laguna	*	UVM	UVM	-	-	UVM	-
P232 111	P332 111	ocean	*	UVM	UVM	-	-	UVM	-
P232 128	P332 128	slate	*	UVM	UVM	-	-	UVM	KS
P232 101	P332 101	snow	KS	UVM	UVM	-	-	UVM	KS
P232 109	P332 109	steel gold-brown	*	UVM	UVM	-	-	UVM	-



Glass doors
Only universal glass doors available

OPACO	Front colour	Carcase	Vis. side	W 19	W50+100	KL/LL	Plinth	Shelving
L232 076	anthracite	*	UVM	UVM	-	-	UVM	-
L232 250	aqua	*	UVM	UVM	-	-	UVM	-
L232 006	bianco	*	UVM	UVM	-	-	UVM	KS
L232 022	black	*	UVM	UVM	-	-	UVM	KS
L232 063	carbon	*	UVM	UVM	-	-	UVM	KS
L232 129	crush gold	*	UVM	UVM	-	-	UVM	-
L232 123	dolphin	KS	UVM	UVM	-	-	UVM	KS
L232 014	fango	*	UVM	UVM	-	-	UVM	KS
L232 024	cashmere	*	UVM	UVM	-	-	UVM	KS
L232 064	pebble-grey	*	UVM	UVM	-	-	UVM	KS
L232 251	laguna	*	UVM	UVM	-	-	UVM	-
L232 111	ocean	*	UVM	UVM	-	-	UVM	-
L232 128	slate	KS	UVM	UVM	-	-	UVM	KS
L232 101	snow	*	UVM	UVM	-	-	UVM	KS
L232 109	steel gold-brown	*	UVM	UVM	-	-	UVM	-



Front: UV matt lacquered surface with anti-fingerprint overlay, 1.0 mm zero joint edge all around, reverse side in the same colour
Note:
19 mm panels UV lacquered on the one side, reverse side in the same colour

Handle drilling options

OPACO

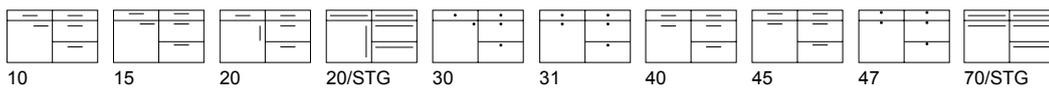

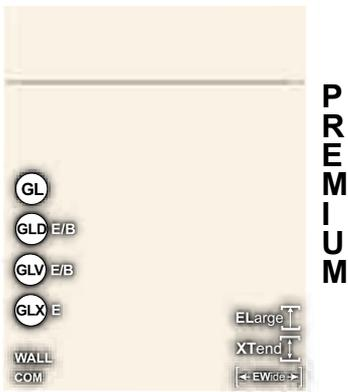

Glass doors
L Door with vertical side stiles

FROST	COM	Front colour	Carcase	Vis. side	W 19	W50+100	KL/LL	Plinth	Shelving
P111 006	P221 006	bianco	KS	SM	SM	SM	-	SM	SM
P111 090	P221 090	magnolia	KS	SM	SM	SM	-	SM	SM
P111 007	P221 007	optiwhite	KS	SM	SM	SM	-	SM	SM



Glass doors
Only universal glass doors available

FROST	Front colour	Carcase	Vis. side	W 19	W50+100	KL/LL	Plinth	Shelving
L111 006	bianco	*	SM	SM	SM	-	SM	SM
L111 007	optiwhite	*	SM	SM	SM	-	SM	SM



Glass doors
L Door with vertical side stiles

FROST	Front colour	Carcase	Vis. side	W 19	W50+100	KL/LL	Plinth	Shelving
N111 006	bianco	KS	SM	SM	-	-	SM	SM
N111 090	magnolia	*	SM	SM	-	-	SM	SM



Front: HPL matt, with zero joint edge all around, reverse side in the same colour

Handle drilling options

FROST

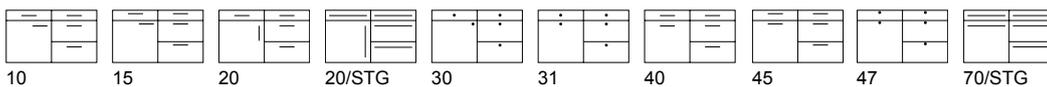

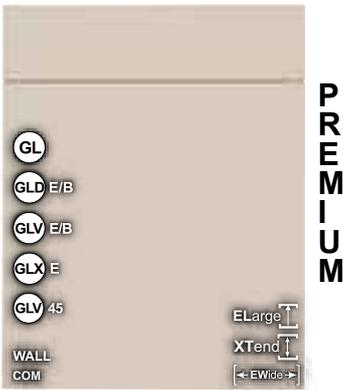

EXTREM	COM	Front colour	Carcase	Vis. side	W 19	W50+100	KL/LL	Plinth	Shelving
P385 022	P485 022	black	KS	XTR	XTR	XTR	-	XTR	KS
P385 017	P485 017	graphite	KS	XTR	XTR	XTR	-	XTR	KS
P385 024	P485 024	cashmere	KS	XTR	XTR	XTR	-	XTR	KS
P385 007	P485 007	optiwhite	KS	XTR	XTR	XTR	-	XTR	KS
P385 126	P485 126	sharky	KS	XTR	XTR	XTR	-	XTR	KS
P385 101	P485 101	snow	KS	XTR	XTR	XTR	-	XTR	KS

Glass doors

L Door with vertical side stiles



Front: HPL front with extremely matt surface and anti-fingerprint overlay with enormous depth of colour, 1.0 mm zero joint edge all around, reverse side in the same colour

Handle drilling options

EXTREM

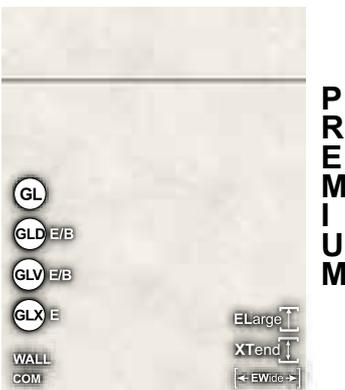
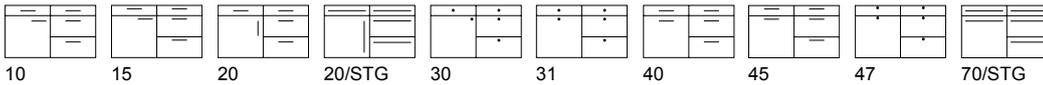

URBAN	COM	Front colour	Carcase	Vis. side	W 19	W50+100	KL/LL	Plinth	Shelving
P265 062	P365 062	cement white	*	SZ	SZ	SZ	-	SZ	-

Glass doors

L Door with vertical side stiles



Front: HPL matt with cement texture and PP edge all around, reverse side identical

Handle drilling options

URBAN

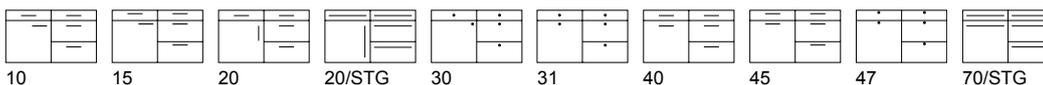

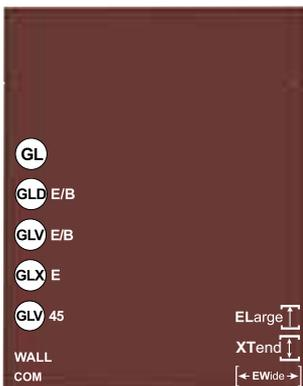

PREMIUM

Glass doors

L Door with vertical side stiles

FENIX	COM	Front colour	Carcase	Vis. side	W 19	W 50	KL/LL	Plinth	Shelving
P310 006	P510 006	bianco	KS	SM/SMF	SM/SMF	SM/SMF	-	SM/SMF	SM
P310 022	P510 022	black	KS	SMF	SMF	SMF	-	SMF	-
P310 134	P510 134	bromo	*	SMF	SMF	SMF	-	SMF	-
P310 135	P510 135	cacao	*	SMF	SMF	SMF	-	SMF	-
P310 091	P510 091	lightgrey	*	SMF	SMF	SMF	-	SMF	-
P310 034	P510 034	kos white	KS	SM/SMF	SM/SMF	SM/SMF	-	SM/SMF	SM
P310 044	P510 044	londra	*	SMF	SMF	SMF	-	SMF	-
P310 110	P510 110	midnight blue	*	SMF	SMF	SMF	-	SMF	-
P310 007	P510 007	optiwhite	KS	SM/SMF	SM/SMF	SM/SMF	-	SM/SMF	SM
P310 136	P510 136	rosso	*	SMF	SMF	SMF	-	SMF	-
P310 137	P510 137	verde	*	SMF	SMF	SMF	-	SMF	-

SPECIAL FEATURES OF FENIX

Lightfast, wipe-proof, resistant to acidic cleaning agents, Nanotech coating, extremely matt surface, soft touch, anti-fingerprint, antibacterial, antistatic, resistant to scratches and abrasions, scratches can be removed using a dirt eraser or hot iron at 80°C.

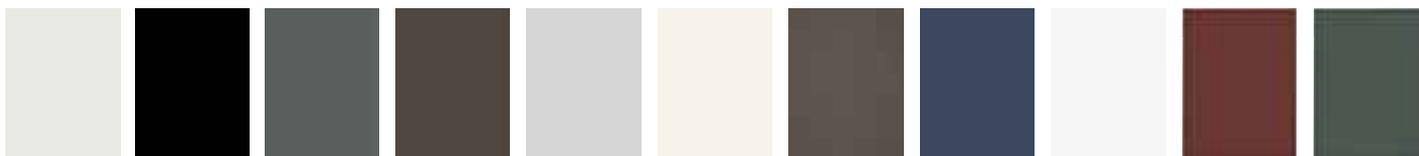

Front: HPL matt with outstanding characteristics, laser edge all around, reverse side in the same colour

Handle drilling options

FENIX

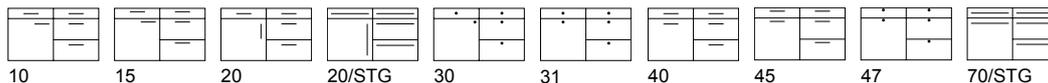

ART-GLAS MATT

Matt acrylic



PREMIUM

Glass doors

Only universal glass doors available

ART-GLAS MATT	Front colour	Carcase	Vis. side	W 19	W50+100	KL/LL	Plinth	Shelving
P383 188	terrificio	*	ACM	ACM*	-	-	ACM	-
P383 187	titanio	*	ACM	ACM*	-	-	ACM	-

*Side panels only available with acrylic on one side, reverse side in same colour!

SPECIAL FEATURES OF ART-GLAS MATT:

- super-matt surface
- 50% lighter
- 10x more breakproof than real glass
- high scratch-resistance
- easy to clean on account of nano properties
- TÜV-approved
- drillable



terrificio titanio

Front: ART-GLAS MATT front in high-quality acrylic with chamfered matt edge, reverse side in same colour.

Handle drilling options

ART-GLAS MATT

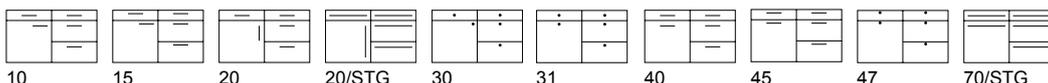



PREMIUM

EFFECTO	COM	Front colour	Carcase	Vis. side	W 19	W50+100	KL/LL	Plinth	Shelving
P506 182	P606 182	bronze dark	*	LM	LM	LM	-	LM	-
P506 186	P606 186	bronze light	*	LM	LM	LM	-	LM	-
P506 183	P606 183	silver	*	LM	LM	LM	-	LM	-
P506 184	P606 184	titanium	*	LM	LM	LM	-	LM	-

EVERY FRONT A UNIQUE ONE-OFF

Involved here is a surface with a special-effect lacquer finish which is largely produced by hand. Differences in the sanding pattern or shading, possibly having the effect that the colour shade appears to vary across the front, are no coincidence, but are desired and intended. Solely this method of working and application lends your furniture its unique character and charisma.

Glass doors

L Door with vertical side stiles

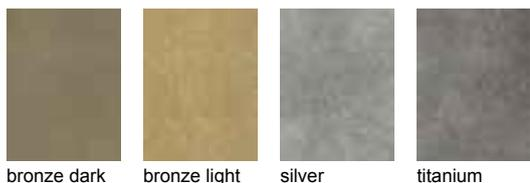

Front: Matt lacquered front with metallic-effect surface and 2 mm radius to all four sides, reverse side colour-matched

Handle drilling options

EFFECTO

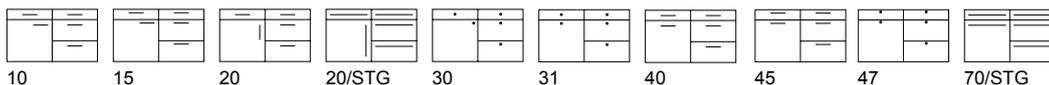



CONCRETE	Front colour	Carcase	Vis. side	W 19	W50+100	KL/LL	Plinth	Shelving
P522 161	clair-light	*	BT	BT	BT	-	BT	-
P522 163	fonce-dark	*	BT	BT	BT	-	BT	-
P522 162	moyen-medium	*	BT	BT	BT	-	BT	-
P522 160	super-bright	*	BT	BT	BT	-	BT	-

Glass doors

G/GA/GM/R Framed door,
L Door with vertical side stiles

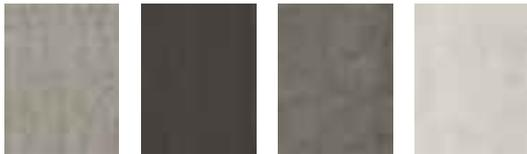

Front: MDF front with real concrete surface,
reverse side in the same colour.

clair-light fonce-dark moyen-medium super-bright

Handle drilling options

CONCRETE

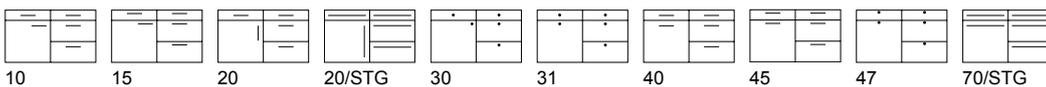

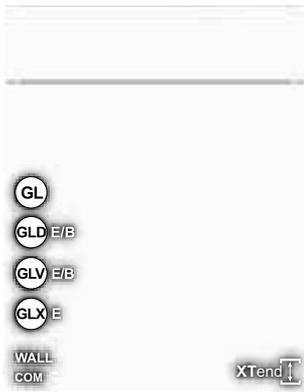

P
R
E
M
I
U
M

Glass doors
L Door with vertical side stiles

LUNA R2	COM	Front colour	Carcase	Vis. side	W 19	W 50	KL/LL	Plinth	Shelving
P219 101	P319 101	snow	KS	UM/ML	UM/ML	UM/ML	-	UM/ML	UM

LUNA R2 RAL COM	Front colour	Carcase	Vis. side	W 19	W 50	KL/LL	Plinth	Shelving
P293 000 P501 000	RAL/Sikkens/NCS	*	ML	ML	ML	-	ML	-



L
I
T
E

Glastüren
Nur universelle Glastüren lieferbar

LUNA R2	Front colour	Carcase	Vis. side	W 19	W 50	KL/LL	Plinth	Shelving
L219 101	snow	*	UM/ML	UM/ML	UM/ML	-	UM/ML	UM

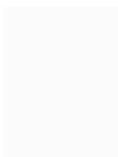

snow



RAL/Sikkens/
NCS colours

All RAL/Sikkens/NCS colours available.

Individual parts only available on request and at extra charge!
No metallic colours available!

Please place repeat orders for RAL fronts within 6 months in order to avoid a difference in colour.

Front: Matt lacquered,
2 mm radius to all four sides, reverse side in the same colour

XTend XTend doors with metal strip at the bottom of the door

Handle drilling options

LUNA R2 + RAL

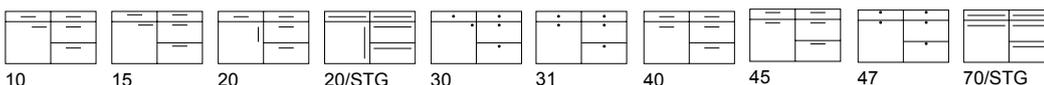



METALLICO	COM	Front colour	Carcase	Vis. side	W 19	W100	KL/LL	Plinth	Shelving
P286 256	P364 256	bronze oxide	*	MT	MT	MT	-	MT	-
P286 257	P364 257	copper	*	MT	MT	MT	-	MT	-
P286 258	P364 258	gold	*	MT	MT	MT	-	MT	-
P286 259	P364 259	platinum	*	MT	MT	MT	-	MT	-

Glass doors

L Door with vertical side stiles



Front: MDF substrate with super-matt metallic PET film, PP edge all around, reverse side always in unicolour light grey. **Panels also available coloured on both sides.**

Handle drilling options

METALLICO

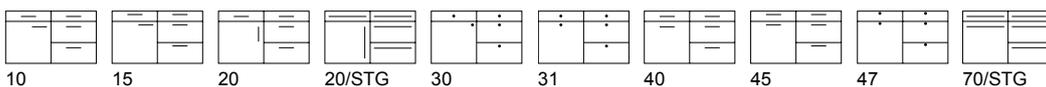

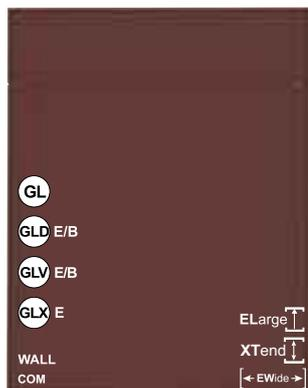

Glass doors
 G/GA/GM/R Framed door,
 L Door with vertical side stiles

LUNA MICRON		COM	Front colour	Carcase	Vis. side	W/WR 19	W 50	KL/LL	Plinth	Shelving
P311 006	P471 006		bianco	KS	MLMi	MLMi	MLMi	-	MLMi	KS
P311 022	P471 022		black	KS	MLMi	MLMi	MLMi	-	MLMi	KS
P311 079	P471 079		blue grey	*	MLMi	MLMi	MLMi	-	MLMi	-
P311 017	P471 017		graphite	KS	MLMi	MLMi	MLMi	-	MLMi	KS
P311 110	P471 110		midnight blue	*	MLMi	MLMi	MLMi	-	MLMi	-
P311 016	P471 016		peach	*	MLMi	MLMi	MLMi	-	MLMi	-
P311 041	P471 041		rust	*	MLMi	MLMi	MLMi	-	MLMi	-
P311 126	P471 126		sharky	KS	MLMi	MLMi	MLMi	-	MLMi	KS
P311 101	P471 101		snow	KS	MLMi	MLMi	MLMi	-	MLMi	KS
P311 113	P471 113		fir green	*	MLMi	MLMi	MLMi	-	MLMi	-
P311 020	P471 020		taupe	*	MLMi	MLMi	MLMi	-	MLMi	-
RAL										
P503 000			RAL/Sikkens/NCS	*	MLMi	MLMi	MLMi	-	MLMi	-

Luna Micron RAL-COM is not available!

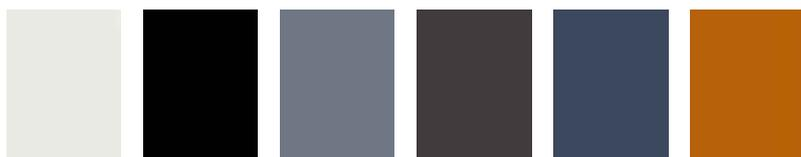

bianco black blue grey graphite midnight blue peach

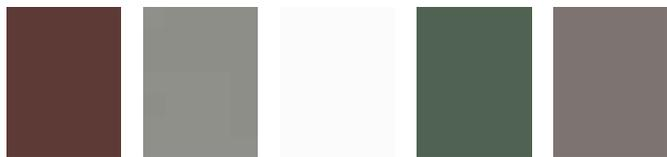

rust sharky snow fir green taupe

Front: Micron-textured lacquer on MDF with 2 mm radius, reverse side in the same colour



All RAL/Sikkens/NCS colours available.

Individual parts only available on request and at extra charge!
 No metallic colours available!

Please place repeat orders for RAL fronts within 6 months in order to avoid a difference in colour.

Handle drilling options

LUNA MICRON

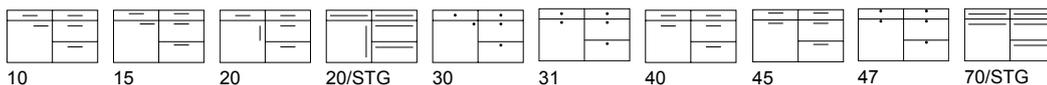

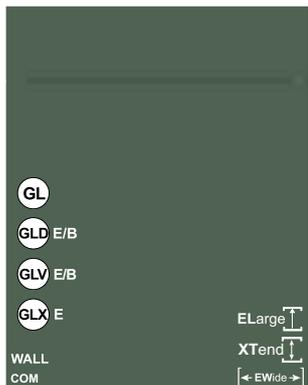

PREMIUM

Glass doors

G/GA/GM/R Framed glass door, L Door with vertical side stiles

LUNA SOFT	COM	Front colour	Carcase	Vis. side	W/WR 19	W 50	KL/LL	Plinth	Shelving
P340 006	P540 006	bianco	KS	MLSO	MLSO	MLSO	-	MLSO	KS
P340 022	P540 022	black	KS	MLSO	MLSO	MLSO	-	MLSO	KS
P340 063	P540 063	carbon	KS	MLSO	MLSO	MLSO	-	MLSO	KS
P340 017	P540 017	graphite	KS	MLSO	MLSO	MLSO	-	MLSO	KS
P340 024	P540 024	cashmere	KS	MLSO	MLSO	MLSO	-	MLSO	KS
P340 064	P540 064	pebble-grey	KS	MLSO	MLSO	MLSO	-	MLSO	KS
P340 044	P540 044	londra	*	MLSO	MLSO	MLSO	-	MLSO	-
P340 090	P540 090	magnolia	KS	MLSO	MLSO	MLSO	-	MLSO	KS
P340 208	P540 208	marone	*	MLSO	MLSO	MLSO	-	MLSO	-
P340 110	P540 110	midnight blue	*	MLSO	MLSO	MLSO	-	MLSO	-
P340 112	P540 112	moos	*	MLSO	MLSO	MLSO	-	MLSO	-
P340 032	P540 032	olive	*	MLSO	MLSO	MLSO	-	MLSO	-
P340 209	P540 209	seta	*	MLSO	MLSO	MLSO	-	MLSO	-
P340 113	P540 113	fir green	*	MLSO	MLSO	MLSO	-	MLSO	-
P340 210	P540 210	urbano	*	MLSO	MLSO	MLSO	-	MLSO	-

Features of anti-fingerprint matt lacquer:

- ultra-matt appearance
- pleasant velvety soft feel
- anti-reflective
- absolutely fingerprint-proof

Note:

- Lacquer is impact-resistant to a limited extent only



Front: matt lacquer with **anti-fingerprint** protection on MDF with 2 mm radius, reverse in same colour

Handle drilling options

LUNA SOFT

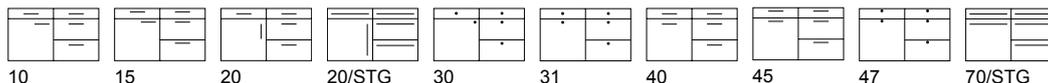



PREMIUM

Glass doors

R Framed glass door
Framed door up to max.1690 mm
from one piece

INSPIRATION SOFT	Front colour	Carcase	Vis. side	W/WR 19	W 50	KL/LL	Plinth	Shelving
P423 006	bianco	KS	MLSO	MLSO	MLSO	-	MLSO	KS
P423 022	black	KS	MLSO	MLSO	MLSO	-	MLSO	KS
P423 063	carbon	KS	MLSO	MLSO	MLSO	-	MLSO	KS
P423 017	graphite	KS	MLSO	MLSO	MLSO	-	MLSO	KS
P423 024	cashmere	KS	MLSO	MLSO	MLSO	-	MLSO	KS
P423 064	pebble-grey	KS	MLSO	MLSO	MLSO	-	MLSO	KS
P423 044	londra	*	MLSO	MLSO	MLSO	-	MLSO	-
P423 090	magnolia	KS	MLSO	MLSO	MLSO	-	MLSO	KS
P423 208	marone	*	MLSO	MLSO	MLSO	-	MLSO	-
P423 110	midnight blue	*	MLSO	MLSO	MLSO	-	MLSO	-
P423 112	moss	*	MLSO	MLSO	MLSO	-	MLSO	-
P423 032	olive	*	MLSO	MLSO	MLSO	-	MLSO	-
P423 209	seta	*	MLSO	MLSO	MLSO	-	MLSO	-
P423 113	fir green	*	MLSO	MLSO	MLSO	-	MLSO	-
P423 210	urbano	*	MLSO	MLSO	MLSO	-	MLSO	-

Features of anti-fingerprint matt lacquer:

- ultra-matt appearance
- pleasant velvety soft feel
- anti-reflective
- absolutely fingerprint-proof

Note:

- Lacquer is impact-resistant to a limited extent only



bianco black carbon graphite cashmere pebble-grey londra magnolia



marone midnight blue moss olive seta fir green urbano

Front: matt lacquer with **anti-fingerprint** protection as single frame with 45° chamfer on MDF with 2 mm radius, reverse in same colour

Handle drilling options

INSPIRATION SOFT

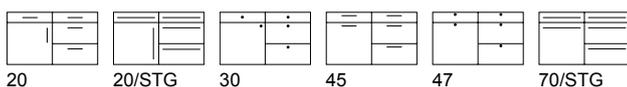



Glass doors
R Framed glass door
Framed door up to max. 1690 mm
from one piece

ELEGANCE SOFT	Front colour	Carcase	Vis. side	W/WR 19	W 50	KL/LL	Plinth	Shelving
P424 006	bianco	KS	MLSO	MLSO	MLSO	-	MLSO	KS
P424 022	black	KS	MLSO	MLSO	MLSO	-	MLSO	KS
P424 063	carbon	KS	MLSO	MLSO	MLSO	-	MLSO	KS
P424 017	graphite	KS	MLSO	MLSO	MLSO	-	MLSO	KS
P424 024	cashmere	KS	MLSO	MLSO	MLSO	-	MLSO	KS
P424 064	pebble-grey	KS	MLSO	MLSO	MLSO	-	MLSO	KS
P424 044	londra	*	MLSO	MLSO	MLSO	-	MLSO	-
P424 090	magnolia	KS	MLSO	MLSO	MLSO	-	MLSO	KS
P424 208	marone	*	MLSO	MLSO	MLSO	-	MLSO	-
P424 110	midnight blue	*	MLSO	MLSO	MLSO	-	MLSO	-
P424 112	moss	*	MLSO	MLSO	MLSO	-	MLSO	-
P424 032	olive	*	MLSO	MLSO	MLSO	-	MLSO	-
P424 209	seta	*	MLSO	MLSO	MLSO	-	MLSO	-
P424 113	fir green	*	MLSO	MLSO	MLSO	-	MLSO	-
P424 210	urbano	*	MLSO	MLSO	MLSO	-	MLSO	-

Features of anti-fingerprint matt lacquer:

- ultra-matt appearance
- pleasant velvety soft feel
- anti-reflective
- absolutely fingerprint-proof

Note:

- Lacquer is impact-resistant to a limited extent only



Front: matt lacquer with **anti-fingerprint** protection as double frame on MDF with 2 mm radius, reverse in same colour

Handle drilling options

ELEGANCE SOFT

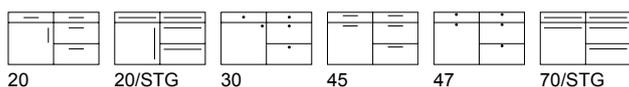



PREMIUM



UNO
One vertical groove
in the middle



R15
Vertical groove spacing
150 mm
Note:
The following front widths
have special groove
spacings:
40+80 cm = 132 mm
50+100 cm = 165 mm



R20
Vertical groove spacing
200 mm
Note:
The following front widths
have special groove
spacings:
30 cm = 148 mm
45+90 cm = 223 mm
50 cm = 248 mm

Glass doors

R Framed glass door,
L Door with vertical side stiles

Features of anti-fingerprint matt lacquer:

- ultra-matt appearance
- pleasant velvety soft feel
- anti-reflective
- absolutely fingerprint-proof

Note:

- Lacquer is impact-resistant to a limited extent only

ZERO	UNO	R15	R20	Front colour	Carcase	Vis. side	W/WR 19	W 50	KL/LL	Plinth	Shelving
P312 006	P313 006	P314 006	P315 006	bianco	KS	MLSO	MLSO	MLSO	-	MLSO	KS
P312 022	P313 022	P314 022	P315 022	black	KS	MLSO	MLSO	MLSO	-	MLSO	KS
P312 063	P313 063	P314 063	P315 063	carbon	KS	MLSO	MLSO	MLSO	-	MLSO	KS
P312 017	P313 017	P314 017	P315 017	graphite	KS	MLSO	MLSO	MLSO	-	MLSO	KS
P312 024	P313 024	P314 024	P315 024	cashmere	KS	MLSO	MLSO	MLSO	-	MLSO	KS
P312 064	P313 064	P314 064	P315 064	pebble-grey	KS	MLSO	MLSO	MLSO	-	MLSO	KS
P312 044	P313 044	P314 044	P315 044	londra	*	MLSO	MLSO	MLSO	-	MLSO	-
P312 090	P313 090	P314 090	P315 090	magnolia	KS	MLSO	MLSO	MLSO	-	MLSO	KS
P312 208	P313 208	P314 208	P315 208	marone	*	MLSO	MLSO	MLSO	-	MLSO	-
P312 110	P313 110	P314 110	P315 110	midnight blue	*	MLSO	MLSO	MLSO	-	MLSO	-
P312 112	P313 112	P314 112	P315 112	moos	*	MLSO	MLSO	MLSO	-	MLSO	-
P312 032	P313 032	P314 032	P315 032	olive	*	MLSO	MLSO	MLSO	-	MLSO	-
P312 209	P313 209	P314 209	P315 209	seta	*	MLSO	MLSO	MLSO	-	MLSO	-
P312 113	P313 113	P314 113	P315 113	fir green	*	MLSO	MLSO	MLSO	-	MLSO	-
P312 210	P313 210	P314 210	P315 210	urbano	*	MLSO	MLSO	MLSO	-	MLSO	-



Front: Matt lacquer anti-fingerprint, outside with beading,
Uno/R15/R20 models with fine grooving,
reverse side in same colour.

Handle drilling options

MILA SOFT ZERO

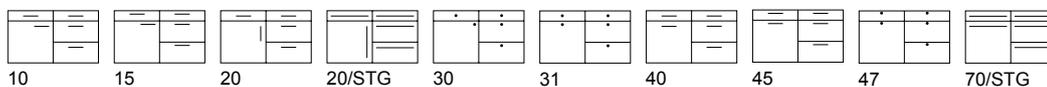

Handle drilling options

MILA SOFT UNO/R15/R20

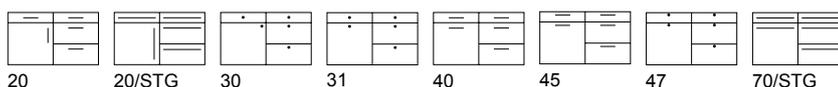



**High-gloss
Line**



PREMIUM

Glass doors

L Door with vertical side stiles

SILK	COM	Front colour	Carcase	Vis. side	W 19	W50+100	KL/LL	Plinth	Shelving
P109 006	P215 006	bianco	KS	EG	EG	EG	-	EG	EG
P109 007	P215 007	optiwhite	KS	EG	EG	EG	-	EG	EG



LITE

Glass doors

Only universal glass doors available

SILK	Front colour	Carcase	Vis. side	W 19	W50+100	KL/LL	Plinth	Shelving
L109 006	bianco	*	EG	EG	EG	-	EG	EG
L109 007	optiwhite	*	EG	EG	EG	-	EG	EG



NEW

Glass doors

L Door with vertical side stiles

SILK	Front colour	Carcase	Vis. side	W 19	W50+100	KL/LL	Plinth	Shelving
N109 006	bianco	KS	EG	EG	-	-	EG	EG
N109 007	optiwhite	*	EG	EG	-	-	EG	EG

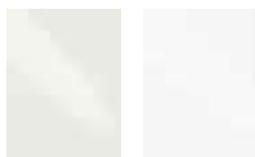

Front: Melamine with fine-gloss surface, glossy laser edge all around, reverse side in the same colour

Handle drilling options

SILK

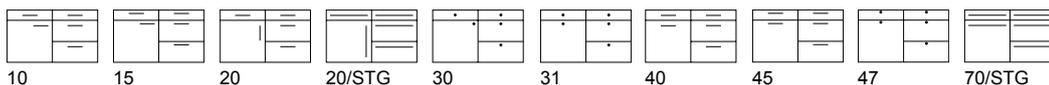

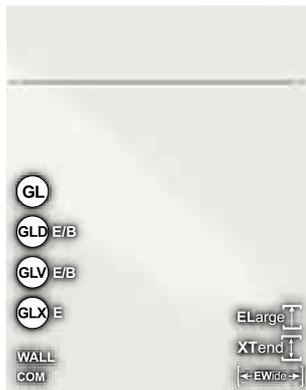

PREMIUM

Glass doors
Door with vertical side stiles

ESPRIT	COM	Front colour	Carcase	Vis. side	W 19	W50+100	KL/LL	Plinth	Shelving
P112 006	P225 006	bianco	KS	SG	SG	SG	-	SG	SG
P112 090	P225 090	magnolia	KS	SG	SG	SG	-	SG	SG
P112 007	P225 007	optiwhite	KS	SG	SG	SG	-	SG	SG
P112 101	P225 101	snow	KS	SG	SG	SG	-	SG	SG



LITE

Glass doors
Only universal glass doors available

ESPRIT	Front colour	Carcase	Vis. side	W 19	W50+100	KL/LL	Plinth	Shelving
L112 006	bianco	*	SG	SG	SG	-	SG	SG
L112 090	magnolia	*	SG	SG	SG	-	SG	SG



NEW

Glass doors
L Door with vertical side stiles

ESPRIT	Front colour	Carcase	Vis. side	W 19	W50+100	KL/LL	Plinth	Shelving
N112 006	bianco	KS	SG	SG	-	-	SG	SG
N112 007	optiwhite	*	SG	SG	-	-	SG	SG



bianco magnolia optiwhite snow

Front: HPL high gloss, zero joint edge all around, reverse side in the same colour

Handle drilling options

ESPRIT

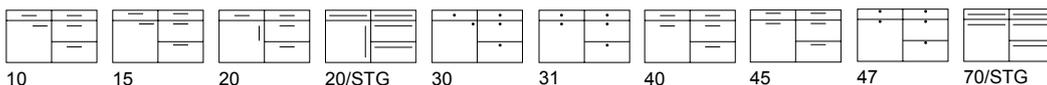

10 15 20 20/STG 30 31 40 45 47 70/STG

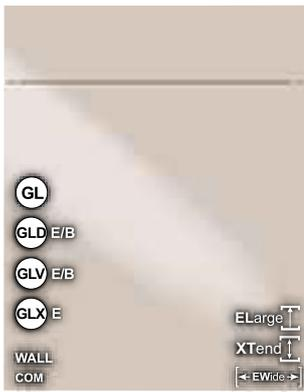

PREMIUM

	LUCE	COM	Front colour	Carcase	Vis. side	W 19	W50+100	KL/LL	Plinth	Shelving
GLV 45	P218 006	P353 006	bianco	KS	SG	SG	SG	-	SG	SG
	P218 095	P353 095	grigio	KS	SG	SG	SG	-	SG	SG
	P218 024	P353 024	cashmere	KS	EG	EG	EG	-	EG	EG
GLV 45	P218 007	P353 007	optiwhite	KS	SG	SG	SG	-	SG	SG
GLV 45	P218 101	P353 101	snow	KS	SG	SG	SG	-	SG	SG

Glass doors
L Door with vertical side stiles



LITE

	LUCE	Front colour	Carcase	Vis. side	W 19	W50+100	KL/LL	Plinth	Shelving
	L218 006	bianco	*	SG	SG	SG	-	SG	SG
	L218 024	cashmere	*	EG	EG	EG	-	EG	EG
	L218 007	optiwhite	*	SG	SG	SG	-	SG	SG
	L218 101	snow	*	SG	SG	SG	-	SG	SG

Glass doors
Only universal glass doors available



NEW

	LUCE	Front colour	Carcase	Vis. side	W 19	W50+100	KL/LL	Plinth	Shelving
	N218 006	bianco	KS	SG	SG	-	-	SG	SG
	N218 095	grigio	*	SG	SG	-	-	SG	SG
	N218 024	cashmere	*	EG	EG	-	-	EG	EG
	N218 007	optiwhite	*	SG	SG	-	-	SG	SG
	N218 101	snow	*	SG	SG	-	-	SG	SG

Glass doors
L Door with vertical side stiles



Front: UV lacquered high gloss, laser edge all around, reverse side in the same colour

Handle drilling options

LUCE

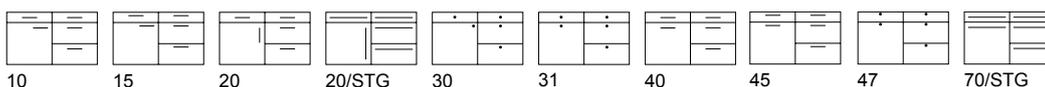



P
R
E
M
I
U
M

Glass doors
Only universal glass doors available

LUCE INF.	COM	Front colour	Carcase	Vis. side	W 19	W50+100	KL/LL	Plinth	Shelving
P158 007	P258 007	optiwhite	*	SG	SG	SG	-	SG	SG
P158 101	P258 101	snow	*	SG	SG	SG	-	SG	SG



L
I
T
E

Glass doors
Only universal glass doors available

LUCE INF.	Front colour	Carcase	Vis. side	W 19	W50+100	KL/LL	Plinth	Shelving
L158 007	optiwhite	*	SG	SG	SG	-	SG	SG
L158 101	snow	*	SG	SG	SG	-	SG	SG



N
E
W

Glass doors
Only universal glass doors available

LUCE INF.	Front colour	Carcase	Vis. side	W 19	W50+100	KL/LL	Plinth	Shelving
N158 007	optiwhite	*	SG	SG	-	-	SG	SG
N158 101	snow	*	SG	SG	-	-	SG	SG



Front: UV lacquered high gloss,
glass-effect laser edge all around,
reverse side in the same colour

Handle drilling options

LUCE INFINITY

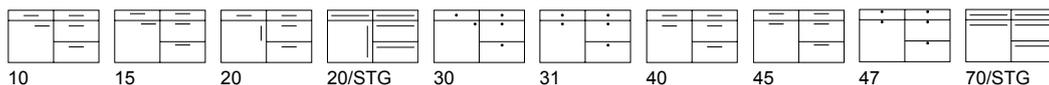

PASSION

COM

RAL

High-gloss lacquered

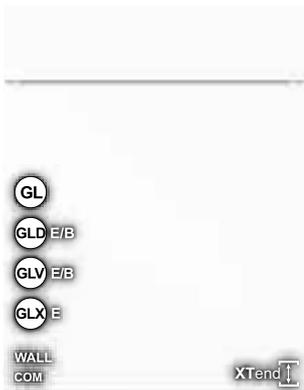

P
R
E
M
I
U
M

- GL
- GLD E/B
- GLV E/B
- GLX E
- WALL COM
- XTend

Glass doors
L Door with vertical side stiles

PASSION	COM	Front colour	Carcase	Vis. side	W 19	W 50	KL/LL	Plinth	Shelving	
P247	101	P357 101	snow	KS	SG/LG	SG/LG	SG/LG	-	SG/LG	SG

PASSION R2 RAL	Front colour	Carcase	Vis. side	W 19	W 50	KL/LL	Plinth	Shelving
P557 000	RAL/Sikkens/NCS	*	LG	LG	LG	-	LG	-

Cavity walls only available in LG!

Passion RAL-COM is not available!



L
I
T
E

- GL
- GLD E/B
- XTend

Glass doors
Only universal glass doors available

PASSION	Front colour	Carcase	Vis. side	W 19	W 50	KL/LL	Plinth	Shelving	
L247	101	snow	*	SG/LG	SG/LG	SG/LG	-	SG/LG	SG

XTend XTend doors with metal strip at the bottom of the door



All RAL/Sikkens/NCS colours available.

Individual parts only available on request and at extra charge! No metallic colours available!

Front: High-gloss lacquered, with 2 mm radius to all four sides, reverse side in the same colour

Please place repeat orders for RAL fronts within 6 months in order to avoid a difference in colour.

snow RAL/Sikkens/NCS colours **GL** XTend WALL

Handle drilling options

PASSION + RAL

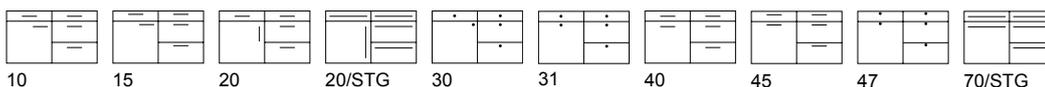



PREMIUM

Glass doors
L Door with vertical side stiles

LUCIDA	COM	Front colour	Carcase	Vis. side	W 19	W 50	KL/LL	Plinth	Shelving
P282 006	P292 006	bianco	KS	SG/LG	SG/LG	SG/LG	-	SG/LG	SG

Cavity walls only available in LG!



LITE

Glass doors
Only universal glass doors available

LUCIDA	Front colour	Carcase	Vis. side	W 19	W 50	KL/LL	Plinth	Shelving
L282 006	bianco	*	SG/LG	SG/LG	SG/LG	-	SG/LG	SG



Front: High-gloss lacquered, with 3 mm radius to all four sides, reverse side in the same colour

XTend XTend doors with metal strip at the bottom of the door

bianco

Handle drilling options

LUCIDA

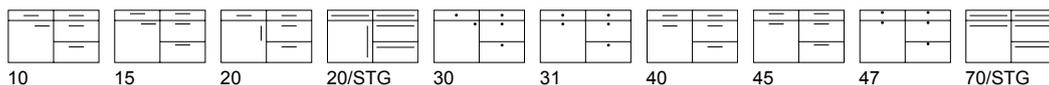



P R E M I U M

ART-GLAS GLOSS	Front colour	Carcase	Vis. side	W 19	W50+100	KL/LL	Plinth	Shelving
P316 006	bianco	KS	ACG	ACG*	-	-	ACG	-
P316 022	black	KS	ACG	ACG*	-	-	ACG	-
P316 105	fumo	*	ACG	ACG*	-	-	ACG	-
P316 024	cashmere	KS	ACG	ACG*	-	-	ACG	-
P316 101	snow	KS	ACG	ACG*	-	-	ACG	-

*Side panels only available with acrylic on one side, reverse side in same colour!

FEATURES OF ART-GLAS GLOSS:

- high-gloss depth effect as with real glass
- 50% lighter
- 10x more breakproof than real glass
- high scratch-resistance
- easy to clean on account of nano properties
- TÜV-approved
- drillable

Glass doors

Only universal glass doors available



bianco black fumo cashmere snow

Front: ART-GLAS GLOSS front in high-quality acrylic with chamfered glossy edge, reverse side in the same colour.

Handle drilling options

ART-GLAS GLOSS

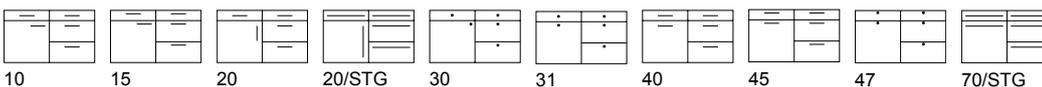



**Foil-wrapped
fronts**

ZERO
without grooves

Glass doors
R Framed glass door,
L Door with vertical side stiles

PREMIUM

UNO
One vertical groove
in the middle

R20
Vertical groove spacing
200 mm
Note:
The following front widths
have special groove
spacings:
30 cm = 148 mm
45+90 cm = 223 mm
50 cm = 248 mm

R15
Vertical groove spacing
150 mm
Note:
The following front widths
have special groove
spacings:
40+80 cm = 132 mm
50+100 cm = 165 mm

R10
Vertical groove spacing
100 mm
Note:
The following front widths
have special groove
spacings:
45 cm = 89 mm

ZERO	UNO	R20	R15	R10	Front colour	Carcase	Vis. side	W 19	W50+100	KL/LL	Plinth	Shelving
P235 006	P236 006	P239 006	P238 006	P237 006	bianco	KS	-	KS*	KS W100	-	KS	KS
P235 017	P236 017	P239 017	P238 017	P237 017	graphite	KS	-	KS*	KS	-	KS	KS
P235 024	P236 024	P239 024	P238 024	P237 024	cashmere	KS	-	KS*	KS	-	KS	KS
P235 090	P236 090	P239 090	P238 090	P237 090	magnolia	KS	-	KS*	KS W100	-	KS	KS
P235 101	P236 101	P239 101	P238 101	P237 101	snow	KS	-	KS*	KS W100	-	KS	KS

KS* in this model foil-wrapped side panels 19 mm thick are also available with grooves!



Front: Foil-wrapped model, **matt** surface, with vertically spaced grooves, reverse side in the same colour

Handle drilling options **GROOVE MATT ZERO**

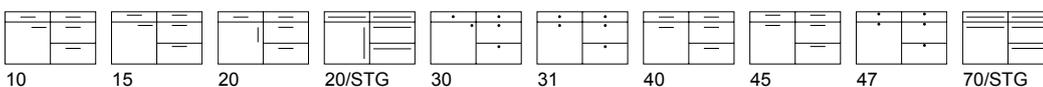

Handle drilling options **GROOVE MATT UNO + R20 + R15 + R10**

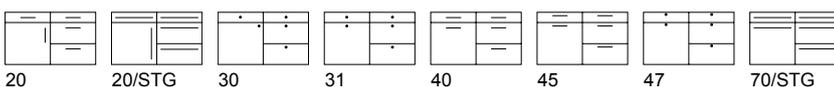

CASTLE MATT

Foil-wrapped



PREMIUM

CASTLE MATT	Front colour	Carcase	Vis. side	W 19	Pilasters	OZ 53/54 KL/LL	Plinth	Shelving
P220 006	bianco	KS	-	KS*	K	KS	KS	KS
P220 017	graphite	KS	-	KS*	K	KS	KS	KS
P220 024	cashmere	KS	-	KS*	K	KS	KS	KS
P220 090	magnolia	KS	-	KS*	K	KS	KS	KS
P220 101	snow	KS	-	KS*	K	KS	KS	KS

Note:

KS* in this model foil-wrapped side panels 19 mm thick are also available with grooves!

Pilaster: K = Foil-wrapped pilaster matt (Castle)

Glass doors

R Framed glass door,
L Door with vertical side stiles



Front: Foil-wrapped Shaker-style door, **matt** surface, with 7 cm frame and grooves, reverse side in the same colour

Handle drilling options CASTLE MATT

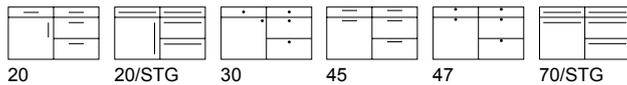

MEDA MATT

Foil-wrapped



PREMIUM

MEDA MATT	Front colour	Carcase	Vis. side	W 19	Pilasters	OZ 14/15 OZ 36/37 KL/LL	Plinth	Shelving
P240 006	bianco	KS	-	KS	K	KS	KS	KS
P240 017	graphite	KS	-	KS	K	KS	KS	KS
P240 024	cashmere	KS	-	KS	K	KS	KS	KS
P240 090	magnolia	KS	-	KS	K	KS	KS	KS
P240 101	snow	KS	-	KS	K	KS	KS	KS

Note:

Pilaster: K = Foil-wrapped pilaster matt (Meda)

Cornice and light pelmet will be matt lacquered in the same colour

Glass doors

R Framed glass door,
L Door with vertical side stiles



Front: Foil-wrapped Shaker-style door, **matt** surface, with 7 cm frame and chamfer, reverse side in the same colour

Handle drilling options MEDA MATT

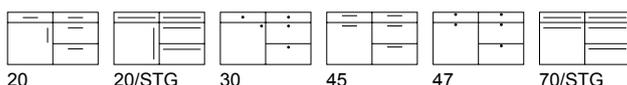

MODERNO MATT

Foil-wrapped



PREMIUM

MODERNO MATT	Front colour	Carcase	Vis. side	W 19	Pilasters	KL/LL	Plinth	Shelving
P241 006	bianco	KS	-	KS	KS W100	-	KS	KS
P241 017	graphite	KS	-	KS	KS	-	KS	KS
P241 024	cashmere	KS	-	KS	KS	-	KS	KS
P241 090	magnolia	KS	-	KS	KS W100	-	KS	KS
P241 101	snow	KS	-	KS	KS W100	-	KS	KS

Glass doors

R Framed glass door,
L Door with vertical side stiles



Front: Foil-wrapped model, **matt** surface,
with 7 cm frame and modern flat centre panel,
reverse side in the same colour

Handle drilling options

MODERNO MATT

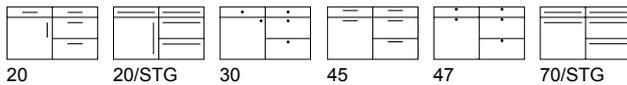

STEP MATT

Foil-wrapped



PREMIUM

STEP MATT	Front colour	Carcase	Vis. side	W 19	Pilasters	KL/LL	Plinth	Shelving
P243 006	bianco	KS	-	KS	K	KS	KS	KS
P243 017	graphite	KS	-	KS	K	KS	KS	KS
P243 024	cashmere	KS	-	KS	K	KS	KS	KS
P243 090	magnolia	KS	-	KS	K	KS	KS	KS
P243 101	snow	KS	-	KS	K	KS	KS	KS

OZ 14/15
OZ 36/37

Note:

Pilaster: K = Foil-wrapped pilaster matt (Step)

Cornice and light pelmet will be matt lacquered
in the same colour

Glass doors

R Framed glass door,
L Door with vertical side stiles



Front: Foil-wrapped Shaker-style door, **matt** surface,
with 7 cm stepped frame, reverse side in the same colour

Handle drilling options

STEP MATT

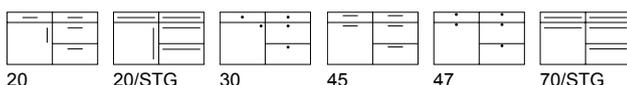



Wood



P
R
E
M
I
U
M

TOSCANA	PM	Front colour	Carcase	Vis. side	W 19	W50+100	Pilasters	KL/LL	Plinth	Shelving
P416 006	P441 006	bianco	KS	FL	FL/FL*	FL	M	FL	FL	FL
P416 022	P441 022	black	KS	FL	FL/FL*	FL	M	FL	FL	FL
P416 017	P441 017	graphite	KS	FL	FL/FL*	FL	M	FL	FL	FL
P416 090	P441 090	magnolia	KS	FL	FL/FL*	FL	M	FL	FL	FL
RAL										
P552 000	P539 000	RAL/Sikkens/NCS	*	FL	FL/FL*	FL	M	FL	FL	FL

OZ 40/41

Country-style elements available!

FL* In this model side panels 19 mm thick are also available with grooves!

Glass doors

H Framed door, glass at top only,
R Framed glass door,
K Crossbar door

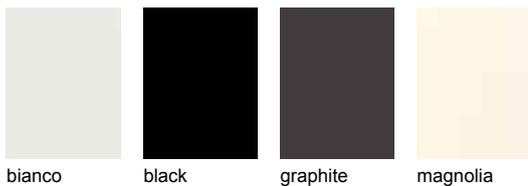

Front: Shaker-style oak front with semi-matt finish,
7 cm solid wood frame, flat veneered, lacquered centre
panel without grooves, reverse side in the same colour
Toscana PM - matt pore
Matt lacquered finish



All RAL/Sikkens/NCS colours available.

Individual parts only available on request and at extra charge!
No metallic colours available!

Please place repeat orders for RAL fronts within 6 months in order to avoid a difference in colour.

Handle drilling options

TOSCANA

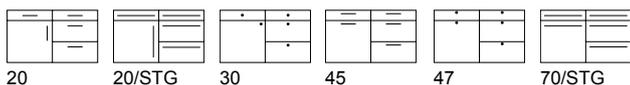



Oak-Line



REAL-OAK H	Front colour	Carcase	Vis. side	Panels	KL/LL	Plinth	Shelving
P397 104	chalk, H	*	FA	FA	-	FA	FA
P397 176	tiramisu, H	*	FA	FA	-	FA	FA
P397 177	real-nature, H	*	FA	FA	-	FA	FA

REAL-OAK V	Front colour	Carcase	Vis. side	Panels	KL/LL	Plinth	Shelving
P396 104	chalk, V	*	FA	FA	-	FA	FA
P396 176	tiramisu, V	*	FA	FA	-	FA	FA
P396 177	real-nature, V	*	FA	FA	-	FA </td <td>FA</td>	FA

W19: Side panels in industrial veneer are only available in a thickness of 19 mm and without grooves.

Glass doors
G/GA/GM/R Framed glass door



Front: Industrial veneer, brushed and lacquered, on raw chipboard substrate, with horizontal/vertical graining, same-coloured edge all around.



We would like to point out that in terms of the structure, colour and number of knots the appearance of the industrial veneer can vary and does not constitute grounds for complaint.

Handle drilling options

REAL-OAK H/V

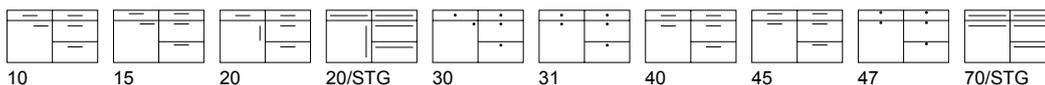

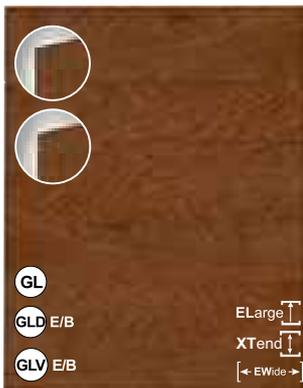

Glass doors
G/GA/GM/R Framed glass door

EDGE H	Edge colour / Front colour	Carcase	Vis. side	Panels	KL/LL	Plinth	Shelving
P392 227	black / chalk, H	*	FA	FA/EFA	-	FA	FA
P392 228	snow / chalk, H	*	FA	FA/EFA	-	FA	FA
P392 229	black / tiramisu, H	*	FA	FA/EFA	-	FA	FA
P392 230	snow / tiramisu, H	*	FA	FA/EFA	-	FA	FA
P392 231	black / real-nature, H	*	FA	FA/EFA	-	FA	FA
P392 232	snow / real-nature, H	*	FA	FA/EFA	-	FA	FA

EDGE V	Edge colour / Front colour	Carcase	Vis. side	Panels	KL/LL	Plinth	Shelving
P390 227	black / chalk, V	*	FA	FA/EFA	-	FA	FA
P390 228	snow / chalk, V	*	FA	FA/EFA	-	FA	FA
P390 229	black / tiramisu, V	*	FA	FA/EFA	-	FA	FA
P390 230	snow / tiramisu, V	*	FA	FA/EFA	-	FA	FA
P390 231	black / real-nature, V	*	FA	FA/EFA	-	FA	FA
P390 232	snow / real-nature, V	*	FA	FA/EFA	-	FA	FA

W19: Side panels in industrial veneer are only available in a thickness of 19 mm and without grooves.

Side panels **W19** are supplied in FA with same-coloured edge, in the EFA model with a choice of black or snow edge, in line with the range.

Front: Industrial veneer, brushed and lacquered, on raw chipboard substrate, with horizontal/vertical graining, edge in a choice of black or snow all around.



We would like to point out that in terms of the structure, colour and number of knots the appearance of the industrial veneer can vary and does not constitute grounds for complaint.

Handle drilling options

EDGE REAL-OAK H/V

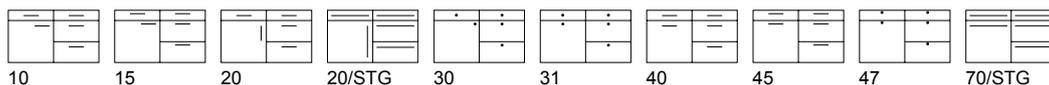



PREMIUM

Glass doors

Only universal glass doors available

LAMELLA	Front colour	Carcase	Vis. side	Panels	KL/LL	Plinth	Shelving
P601 022	black	KS	FA	FA	-	FA	FA
P601 104	chalk	*	FA	FA	-	FA	FA
P601 103	chestnut	*	FA	FA	-	FA	FA

Side panels are only available without slats!



black chalk chestnut

Front: Veneered brushed oak front, on MDF substrate, with horizontal slats. The groove between the slats is 13 mm wide. The front is 21.7 mm thick, reverse side in the same colour.

Due to the horizontal grooving GL780 and S126 cannot be combined (tall units with vertical GL-strip cannot be combined with handleless base units)

Handle drilling options

LAMELLA

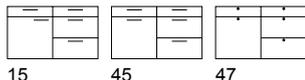

15 45 47

NOTCHO



PREMIUM

Glass doors

Only universal glass doors available

NOTCHO	Front colour	Carcase	Vis. side	Panels	KL/LL	Plinth	Shelving
P670 022	black	KS	FR*	FR*	-	FR	-
P670 102	nature	-	FR*	FR*	-	FR	-
P670 216	walnut	-	FR*	FR*	-	FR	-

Note:

* Visible side only available without grooves

* Panels 19 mm only available with grooves on one side (OLWR, 20 mm thick) or without grooves on both sides (OLW)

Panels 50-100 mm only available without grooves

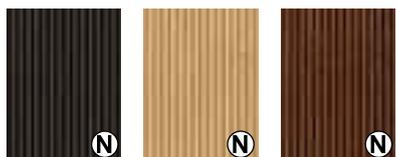

black nature walnut



All RAL/Sikkens/NCS colours available.

Individual parts only available on request and at extra charge! No metallic colours available!

Front: Vertically grooved front (oak: black and nature, walnut) on raw chipboard/MDF substrate with 2 veneer thicknesses. Front thickness 20 mm, reverse side in the same colour but without grooves

Only available handleless or with TIP-ON; drill holes are not possible.

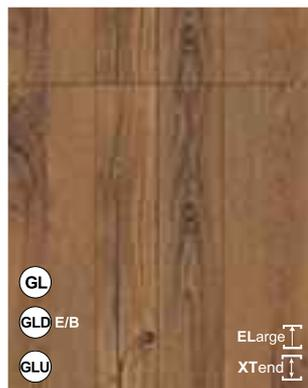

**P
R
E
M
I
U
M**

PLANK-OAK	Front colour	Carcase	Vis. side	Panels	KL/LL	Plinth	Shelving
P516 103	chestnut	*	FA	FA/*	-	FA	FA
P516 030	loam	*	FA	FA/*	-	FA	FA
P516 028	natural knotty oak	*	FA	FA/*	-	FA	FA

Note:

- * Visible sides are brushed, not planked
- * Shelving is brushed
- * FA/* In this model the side panels are sandblasted, available as a planked or non-planked version in a thickness of 19, 50, 75, 100 mm (if necessary OLWR)
The standard type is the smooth/flat version

Glass doors

L Door with vertical side stiles



chestnut loam natural knotty oak

Front: veneered old oak, vertically planked (butting against veneer) and sandblasted, reverse side in the same colour

Handle drilling options

PLANK-OAK

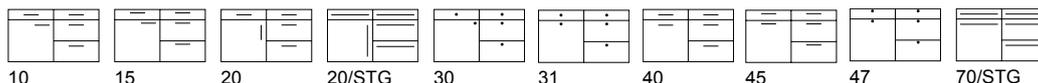

ROUGH ZERO + R15



**P
R
E
M
I
U
M**

ZERO	R15	Front colour	Carcase	Vis. side	Panels	KL/LL	Plinth	Shelving
P565 022	P567 022	black	KS	FR	FR	-	FR	-
P565 017	P567 017	graphite	KS	FR	FR	-	FR	-
P565 155	P567 155	pastell loam	*	FR	FR	-	FR	-
P565 156	P567 156	pastell shadow	*	FR	FR	-	FR	-
P565 157	P567 157	pastell smoke	*	FR	FR	-	FR	-
P565 158	P567 158	plage	*	FR	FR	-	FR	-

In this model side panels in 19, 50, 75 and 100 mm are available with or without grooves

Note for R15:

The following fronts have different groove spacings
 40 + 80 cm = 132 mm
 50 cm = 124 mm
 100 cm = 142 mm

Glass doors

L Door with vertical side stiles



black graphite pastell loam pastell shadow pastell smoke plage

Front: Thick oak veneer sandblasted, without grooves (ZERO) or with grooves at 150 mm spacings (R15), vertical graining, reverse side in the same colour

Handle drilling options

ROUGH ZERO

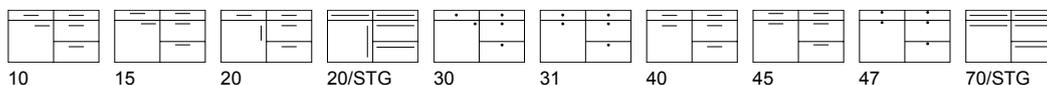

Handle drilling options

ROUGH R15

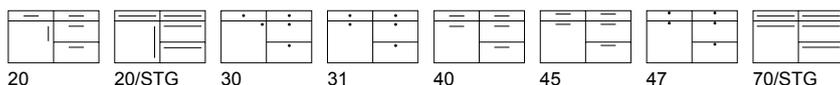



CADRE	Front colour	Carcase	Vis. side	Panels	KL/LL	Plinth	Shelving
P439 022	black	KS	FA	FA	-	FA	FA
P439 103	chestnut	*	FA	FA	-	FA	FA
P439 028	natural knotty oak	*	FA	FA	-	FA	FA

Glass doors

RQ framed glass door with horizontal rail



black chestnut natural knotty oak

Front: 23 mm thick, at top and bottom 9 cm wide solid sandblasted rail, with integral fingerrip recess, sited inbetween on left and right 5.5 cm wide flattened rail, centre panel in brushed veneer, reverse in same colour.

Note:

- drawer panels (plain) are only available with TIP-ON, as an alternative we recommend pull-out panels with interior drawers.
- Pull-out panels 256 mm high are not available.
- A door width of 296 mm should not be exceeded, otherwise available in plain finish only.
- Ideally, fridges should be planned at a height of 78 cm in order to ensure easy opening of the door.

BLACK-LINE



BLACK-LINE	Front colour	Carcase	Vis. side	W 19	Panels	KL/LL	Plinth	Shelving
P528 102	nature	black	FA*	FA	FA	-	FA	-

FA*: The face of visible sides is always supplied with grooving, the front edge is without grooving. The reverse side of the visible side is black. Side panels 19 and 50 mm: available with grooving on one side and on the edge, side panels 75 and 100 mm are not available!

Glass doors

G/GA/GM/R Framed door



nature

Front: Brushed oak veneer on black MDF, horizontal grooving, reverse side oak veneer without grooving

Note:

- With GLV45 and GLU the black MDF is always visible on the handle side
- On account of the horizontal grooving **GL780 and S126 cannot be combined** (tall units with vertical GL-strip cannot be combined with handleless base units!)
- Doors outside of the modular grid are not predrilled at the factory

Handle drilling options

BLACK-LINE (only for handle 466/467/470)



45

62



ZERO
without grooves
Flat veneered front

Glass doors

G/GA/GM/R Framed glass door only available for the ZERO range,
L Door with vertical side stiles

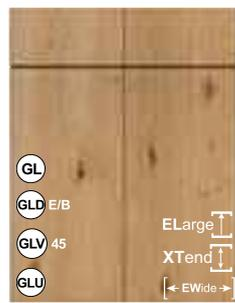

UNO
One vertical groove
in the middle



R20
Vertical groove spacing
200 mm
Note:
The following front
widths
have special groove
spacings:
30 cm = 148 mm
45+90 cm = 223 mm
50 cm = 248 mm

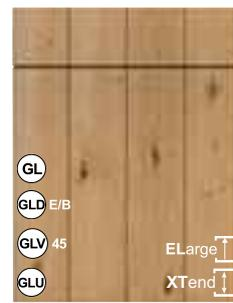

R15
Vertical groove spacing
150 mm
Note:
The following front
widths
have special groove
spacings:
40+80 cm = 132 mm
50+100 cm = 165 mm

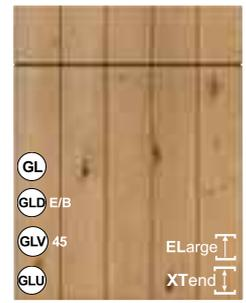

R10
Vertical groove spacing
100 mm
Note:
The following front widths
have special groove
spacings:
45 cm = 89 mm

ZERO	UNO	R20	R15	R10	Front colour	Carcase	Vis. side	Panels	KL/LL	Plinth	Shelving
P410 019	P431 019	P435 019	P414 019	P433 019	beachwood	*	FA	FA/*	-	FA	FA
P410 006	P431 006	P435 006	P414 006	P433 006	bianco	KS	FA	FA/*	-	FA	FA
P410 022	P431 022	P435 022	P414 022	P433 022	black	KS	FA	FA/*	-	FA	FA
P410 031	P431 031	P435 031	P414 031	P433 031	driftwood	*	FA	FA/*	-	FA	FA
P410 017	P431 017	P435 017	P414 017	P433 017	graphite	KS	FA	FA/*	-	FA	FA
P410 030	P431 030	P435 030	P414 030	P433 030	loam	*	FA	FA/*	-	FA	FA
P410 028	P431 028	P435 028	P414 028	P433 028	natural knotty oak	*	FA	FA/*	-	FA	FA

RAL ZERO	UNO	R20	R15	R10	Front colour	Carcase	Vis. side	Panels	KL/LL	Plinth	Shelving
P511 000	P531 000	P535 000	P514 000	P533 000	RAL/Sikkens/NCS	*	FA	FA/*	-	FA	FA

FA* In this model side panels in 19, 50, 75 and 100 mm thickness are available with or without grooves



All RAL/Sikkens/NCS colours available.

Individual parts only available on request and at extra charge! No metallic colours available!



Front: Veneered with vertical graining, heavily brushed and lacquered, reverse side in the same colour, wood edge all around

Handle drilling options

MERINO anticato ZERO

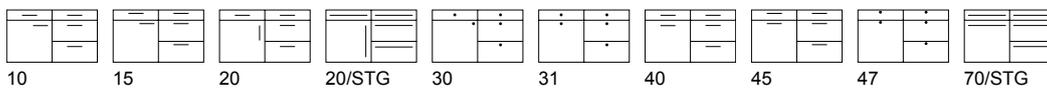

Handle drilling options

MERINO anticato UNO + R20 + R15 + R10

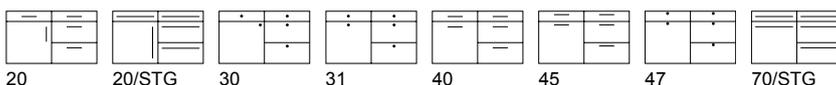



PREMIUM

SPLIT-OAK H	Front colour	Carcase	Vis. side	Panels	KL/LL	Plinth	Shelving
P480 102	nature, H	*	FA	FA	-	FA	FA
SPLIT-OAK V	Front colour	Carcase	Vis. side	Panels	KL/LL	Plinth	Shelving
P481 102	nature, V	*	FA	FA	-	FA	FA

Glass doors

G/GA/GM/R Framed glass door,
H Framed door, glass at top only



nature, **H** nature, **V**

Front: Veneered split-oak, heavily brushed with **horizontal/vertical graining**, reverse side in the same colour

Handle drilling options

SPLIT-OAK H + V anticato

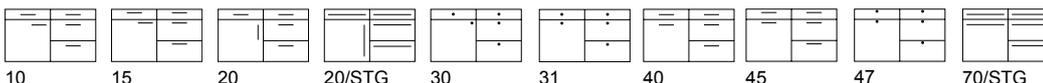

PREMIUM

INTENSE H	Front colour	Carcase	Vis. side	W 19	Panels	KL/LL	Plinth	Shelving
P684 102	nature, H	*	FR	FR	-	-	FR	-
INTENSE V	Front colour	Carcase	Vis. side	W 19	Panels	KL/LL	Plinth	Shelving
P685 102	nature, V	*	FR	FR	-	-	FR	-

Only 19 mm side panels, embossed on the one side, are available (with non-embossed edge)!

Glass doors

G/GA/GM/R Framed glass door,
L Door with vertical side stiles



nature, **H** nature, **V**

Front: Deep embossed wild oak front with 3D-effect rough-look surface, **horizontal/vertical graining**, front only available with non-embossed edge. Reverse side in the same colour

Handle drilling options

INTENSE H + V

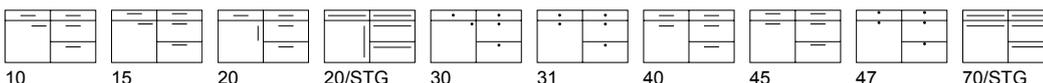

LEGNO H/V

Oak-Line

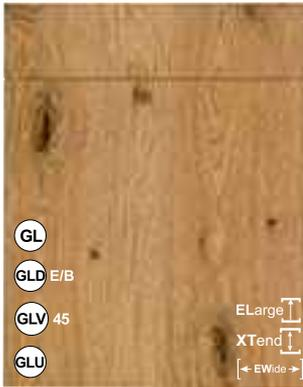

LEGNO H	Front colour	Carcase	Vis. side	Panels	KL/LL	Plinth	Shelving
P675 102	nature, H	-	FR	FR	-	FR	-
LEGNO V	Front colour	Carcase	Vis. side	Panels	KL/LL	Plinth	Shelving
P675 102	nature, V	-	FR	FR	-	FR	-

* Visible sides are brushed

Glass doors

G/GA/GM/R Framed glass door,
H Framed door, glass at top only

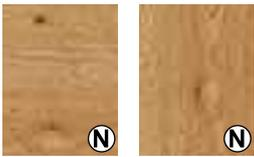

Front: Sandblasted thick knotty oak veneer, with horizontal or vertical graining, on raw chipboard substrate
The front is 21 mm thick, reverse side in the same colour
W19 is 21 mm thick

Handle drilling options

LEGNO H + V

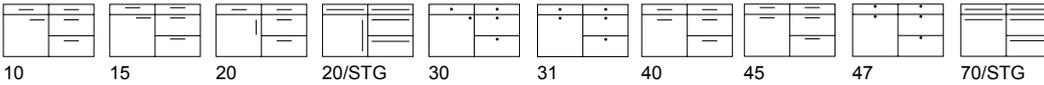

TELAIO anticato

RAL

Oak-Line



TELAIO	Front colour	Carcase	Vis. side	Panels	KL/LL	Plinth	Shelving
P418 006	bianco	KS	FA	FA/*	-	FA	FA
P418 031	driftwood	*	FA	FA/*	-	FA	FA
P418 017	graphite	KS	FA	FA/*	-	FA	FA
P418 028	natural knotty oak	*	FA	FA/*	-	FA	FA
RAL							
P518 000	RAL/Sikkens/NCS	*	FA	FA/*	-	FA	FA

FA/* In this model side panels 19, 50, 75 and 100 mm thickness are available with or without grooves (grooves as INCAVO)

Glass doors

R, Framed glass door,
H Framed door, glass at top only



All RAL/Sikkens/NCS colours available.
Individual parts only available on request and at extra charge!
No metallic colours available!
Please place repeat orders for RAL fronts within 6 months in order to avoid a difference in colour.

Front: Solid sandblasted front in knotty oak, veneered centre panel, 9 cm wide frame, lacquered, reverse side in the same colour

Handle drilling options

TELAIO

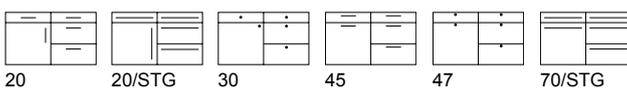



**P
R
E
M
I
U
M**

INCAVO	Front colour	Carcase	Vis. side	Panels	KL/LL	Plinth	Shelving
P419 006	bianco	KS	FA	FA/*	-	FA	FA
P419 031	driftwood	*	FA	FA/*	-	FA	FA
P419 017	graphite	KS	FA	FA/*	-	FA	FA
P419 028	natural knotty oak	*	FA	FA/*	-	FA	FA
RAL							
P519 000	RAL/Sikkens/NCS	*	FA	FA/*	-	FA	FA

FA/* In this model side panels 19, 50, 75 and 100 mm thickness are available with or without grooves

Glass doors

R, Framed glass door,
H Framed door, glass at top only

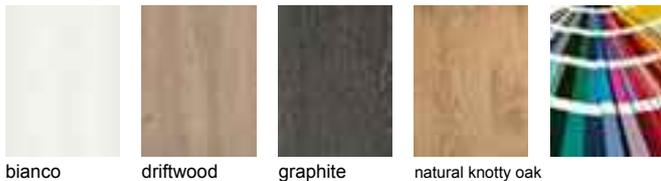

All RAL/Sikkens/NCS colours available.

Individual parts only available on request and at extra charge!

No metallic colours available!

Please place repeat orders for RAL fronts within 6 months in order to avoid a difference in colour.

Front: Solid sandblasted front in knotty oak, veneered centre panel with one groove (one central groove in all widths), 9 cm wide frame, lacquered, reverse side in the same colour

Handle drilling options INCAVO

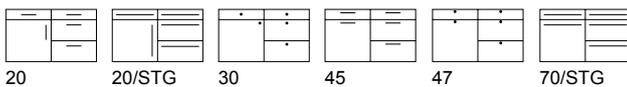

**P
R
E
M
I
U
M**

ORBITA	Front colour	Carcase	Vis. side	Panels	KL/LL	Plinth	Shelving
P447 031	driftwood	*	FA	FA/*	-	FA	FA
P447 030	loam	*	FA	FA/*	-	FA	FA
P447 028	natural knotty oak	*	FA	FA/*	-	FA	FA
RAL							
P547 000	RAL/Sikkens/NCS	*	FA	FA/*	-	FA	FA

FA/* In this model side panels in 19, 50, 75 and 100 mm thickness are available with or without grooves (grooves as SOLCO)

Note:

Doors less than 296 mm wide will be supplied without frame.

Glass doors

R Framed glass door,
H Framed door, glass at top only



All RAL/Sikkens/NCS colours available.

Individual parts only available on request and at extra charge!

No metallic colours available!

Please place repeat orders for RAL fronts within 6 months in order to avoid a difference in colour.

Front: Solid, rustic finished and sandblasted door in knotty oak, 11 cm frame, veneered centre panel, lacquered, reverse side in the same colour

Handle drilling options ORBITA

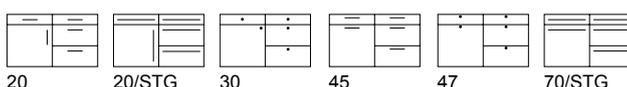

STRETTO anticato

Oak-Line



PREMIUM

STRETTO	Front colour	Carcase	Vis. side	Panels	KL/LL	Plinth	Shelving
P452 022	black	KS	FA	FA	-	FA	FA
P452 103	chestnut	*	FA	FA	-	FA	FA
P452 028	natural knotty oak	*	FA	FA	-	FA	FA

Glass doors

Only universal glass doors available



black chestnut natural knotty oak

Front: 21 mm thick, at top and bottom 8 cm wide solid sandblasted rail, sited inbetween on left and right 1.2 cm wide rail sandblasted veneered centre panel, reverse in the same colour

Handle drilling options STRETTO

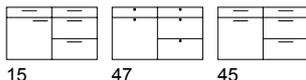

15 47 45

RIPIENO anticato

Oak-Line



PREMIUM

RIPIENO	Front colour	Carcase	Vis. side	Panels	KL/LL	Plinth	Shelving
P437 019	beachwood	*	FA	FA/*	-	FA	FA
P437 031	driftwood	*	FA	FA/*	-	FA	FA
P437 030	loam	*	FA	FA/*	-	FA	FA
P437 028	natural knotty oak	*	FA	FA/*	-	FA	FA

FA/* In this model side panels in 19, 50, 75 and 100 mm thickness are available with or without grooves (grooves as INCAVO)

Note:

Doors less than 296 mm wide will be supplied without frame. Pull-out panels less than 352 mm high will be supplied with flat centre panel.

Glass doors

R Framed glass door,
H Framed door, glass at top only



beachwood driftwood loam natural knotty oak

Front: Solid, rustic finished and sandblasted door in knotty oak, 11 cm frame, solid wood centre panel, lacquered, reverse side in the same colour

Handle drilling options RIPIENO

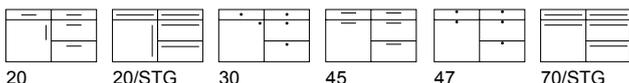

20 20/STG 30 45 47 70/STG



Handles,
worktops decors,
colour charts and
discontinued lines

Handles | Knobs

Handles/Knobs	No.	Details	Handles/Knobs	No.	Details
	200	chrome/matt, 160 mm GRIBO: 10 - 15 - 20 - 40 - 45		384	black, 160 mm overall length 206 mm GRIBO: 10 - 15 - 20 - 40 - 45
	222	Slender stainless steel handle, 192 mm ● GRIBO: 10 - 15 - 20 - 40 - 45		385	black knurled, 160 mm overall length 188 mm ● GRIBO: 10 - 15 - 20 - 40 - 45
	226	titanium coloured, 192 mm overall length 204 mm GRIBO: 10 - 15 - 20 - 40 - 45		386	black, 160 mm overall length 181 mm GRIBO: 10 - 15 - 20 - 40 - 45
	270	Matt brushed nickel, 128 mm ● GRIBO: 10 - 15 - 20 - 40 - 45		392	Stainless steel, 160 mm GRIBO: 10 - 15 - 20 - 40 - 45
	279	Zinc, 128 mm GRIBO: 10 - 15 - 20 - 40 - 45		393	Matt black, 160 mm GRIBO: 10 - 15 - 20 - 40 - 45
	285	Stainless steel coloured, 160 mm MP ● GRIBO: 10 - 15 - 20 - 40 - 45		394	rose-gold, 160 mm GRIBO: 10 - 15 - 20 - 40 - 45
	289	Anticato, 224 mm colour deviations are possible (restricted use on panels of 300 mm and less) MP for all price groups ● GRIBO: 10 - 15 - 20 - 40 - 45		413	Antiqued brown, 192 mm MP ● GRIBO: 10 - 15 - 20 - 40 - 45
	297	Stainless steel coloured, 128 mm GRIBO: 10 - 15 - 20 - 40 - 45		414	Antiqued brown, 288 mm only in combination with handle 413 MP ● GRIBO: 40 - 45
	298	Stainless steel finish, 192 mm overall length 230 mm GRIBO: 10 - 15 - 20 - 40 - 45		421	Stainless steel look, 160 mm ● GRIBO: 10 - 15 - 20 - 40 - 45
	299	Stainless steel look, 128 mm ● GRIBO: 10 - 15 - 20 - 40 - 45		422	Stainless steel look, 320 mm only in combination with handle 421 used from 600 mm width MP ● GRIBO: 40 - 45

Melamine
fronts

Matt-Line

High-gloss Line

Foil-wrapped fronts

Wood

Oak-Line

Handles, worktops decors, colour charts and discontinued lines

Handles | Knobs

Handles/Knobs	No.	Details	Handles/Knobs	No.	Details
	423	brushed brass, 160 mm overall length 170 mm ● GRIBO: 10 - 15 - 20 - 40 - 45		452	Antiqued black, 160 mm MP GRIBO: 10 - 15 - 20 - 40 - 45
	424	black, 160 mm overall length 200 mm MP GRIBO: 10 - 15 - 20 - 40 - 45		453	Stainless steel look, 192 mm ● GRIBO: 10 - 15 - 20 - 40 - 45
	425	Stainless steel coloured, 160 mm overall length 170 mm ● GRIBO: 10 - 15 - 20 - 40 - 45		461	Matt black, 192 mm overall length 200 mm GRIBO: 10 - 15 - 20 - 40 - 45
	435	Matt black, 160 mm overall length 170 mm ● GRIBO: 10 - 15 - 20 - 40 - 45		506	short bar handle STGE Stainless steel, 184 mm fixed overall length 226 mm MP ● GRIBO: 10 - 15 - 20 - 40 - 45
	436	Matt black lacquered, 192 mm overall length 199 mm GRIBO: 10 - 15 - 20 - 40 - 45		507	short bar handle STGEB powder-coated black, 184 mm fixed overall length 226 mm MP ● GRIBO: 10 - 15 - 20 - 40 - 45
	437	Matt black powder-coated, 128 mm overall length 164 mm GRIBO: 10 - 15 - 20 - 40 - 45			
	438	dark metal with weld seams, 160 mm overall length 175 mm MP for all price groups ● GRIBO: 10 - 15 - 20 - 40 - 45		313	Knob stainless steel ● GRIBO: 31 - 47
	439	dark metal with weld seams, 320 mm, overall length 335 mm only in combination with handle 438 used from a width of 600 mm MP for all price groups ● GRIBO: 40 - 45		314	knob, black lacquered, 16 mm Vertical drilling is not possible! ● GRIBO: 40 - 45
	440	black, 160 mm sloping door position GRIBO: 10 - 15 - 20 - 40 - 45		372	Knob anticato colour deviations are possible MP ● GRIBO: 30 - 47
	441	black, 320 mm sloping door position only in combination with handle 440 used from a width of 600 mm MP GRIBO: 40 - 45		373	Knob stainless steel ● GRIBO: 30 - 47

Handles | Knobs

Handles/Knobs	No.	Details
	466	Strip handle in brushed black GRIBO: 10 - 15 - 20 - 40 - 45
	467*	160 mm drilling distance overall length 225 mm / *375 mm, handle cut-out 130 mm centred the profile is a fixed size for all widths MP ● GRIBO: 40 - 45 <small>as from 450 mm cabinet width</small>
	470	Handle combination comprising: 466 overall length 225 mm (for widths 300 + 400 mm) 467 overall length 375 mm (for widths 450 up to 500 mm) 468 overall length 525 mm (for widths 600 + 800 mm) 469 overall length 825 mm (for widths 900 - 1200 mm) used in combination MP ● GRIBO: 40 - 45

On Shaker-style or profiled doors only vertical (not horizontal) drilling is possible.

MP = PG 0, 1, 2 + 2A Handles available at extra charge.

- = **Planning advice:** in corner solutions it is important to consider the 700 x 700 mm corner in order to guarantee flawless function.

BAR HANDLES ARE AVAILABLE ACROSS ALL PRICE GROUPS AT EXTRA CHARGE ONLY.

Bar handles	No.	Details
	STGE	stainless steel MP ● GRIBO: 20/STG - 70/STG
	STGEB	Powder-coated black MP ● GRIBO: 20/STG - 70/STG

GRIBO - Handle drilling options

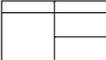
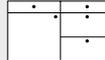
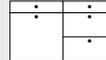
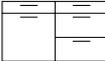
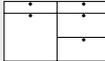
 GRIBO 1 without drilling	 GRIBO 10 horizontal	 GRIBO 15 horizontal, high-set	 GRIBO 20 vertical	 GRIBO 20/STG vertical bar handle	 GRIBO 30 knob drilling	 GRIBO 31 knob drilling centred
 GRIBO 40 centred Only available for flat fronts.	 GRIBO 45 centred, high-set	 GRIBO 47 knob drilling centred, high-set	 GRIBO 70/STG hor. bar handle			



08 COM strip down 995
black



09 COM strip rounded 996
stainless steel



10 COM strip square 997
stainless steel



WALL-strip 920
black

Notes:

- Extra charge per strip handle
 - Use base unit items from S126
 - Use wall unit items from GL780 (XH)
 - Use tall unit items from S126
- Upper doors/flaps on units housing appliances are always supplied with Tip-On
For fridges a special strip handle is used
Please note that only restricted versions for fridges are possible
Due to the position of the strip handle, only split fridge/freezer combinations are possible

The following items are not available:

- Pull-out 256 mm high, seated at the bottom of a base/tall unit can only be supplied as a drawer
- UAG 45/60 26 and UGG 45/60 39 - pull-out to be opened from underneath
- U2AG 45/60 52 are not available
- UE 83/93 78/91 are not available
- For corner units USPV..., UV..., GV4L..., AGV2L... the precise planning size must be specified
- GEL..., GGEL..., GGEL2..., GKL... are not available



01	GL Handleless (flat door)	NL	LL	PL
02	GLD-E/B Handleless decor (flat door), profile stainless steel or black		LL	PL
03	GLV-E/B Handleless (door with 45° chamfer + metal strip), stainless steel or black			PL
04	GLX-E Handleless (door with 90° routing + stainless steel strip)			PL
05	GLV-45 Handleless (door with 45° chamfer)			PL
06	GLX-90 Handleless (door with 90° routing)			PL
07	GLU Handleless (wooden door with U-routing)			PL

Worktop decors



1000 ALPINWEISS



1001 ANTHRAZIT SOLID COLOR



1002 ARKOSA SAND



1003 ARLINTON EICHE



1009 BETON ART PERLGRAU



1010 BETON DUNKEL



1011 BÉTON CLAIR



1012 BETON NATUR



1013 BLOCK BOARD NOCHE



1015 BORDOLINO EICHE GRAU



1017 CERAMIC ANTHRAZIT



1018 CERAMICO ROST



1019 ANTHRACITE CHROMIX



1020 CODY WEISS

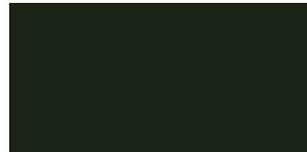

1025 DARK NIGHT



1031 CHÉNE SABLE SANREMO



1032 ESCHE MOLINA SAND



1033 FLASH BLACK



1034 GLADSTONE OAK GREIGE



1036 GLITTERSTONE LIGHT



1037 GRAPHITGRAU



1039 HALIFAX EICHE WEISS



1041 ICY WHITE SOLID COLOR



1043 JURAMARMOR

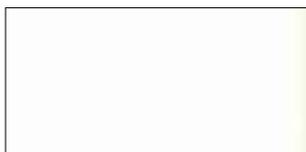

1046 KRISTALLWEISS SOLID COLOR



1047 KUPFER



1049 LICHTGRAU



1053 METALLO GRAUBRAUN

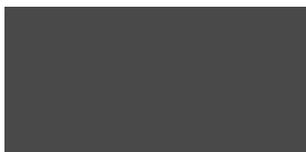

1054 METALLSCHWARZ



1060 NATURAL LANCELOT OAK



1062 NEGRO BRASIL



1068 PALE LANCELOT OAK



1069 PAPYRUS NUBIA BRAUN



1072 RAJA BLACK



1077 SANDGRAU



1095 TIVOLI

Worktop decors



1100 VICENZA EICHE HELL



1104 WEISS STEINSTRUKTUR



1107 DOLPHIN



1108 SLATE



1109 HALIFAX EICHE NATUR



1110 CRUSH GOLD



1111 HALIFAX CRACK OAK



1150 CARBON

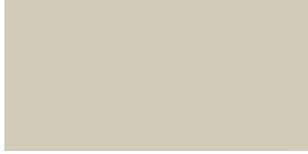

1160 PEBBLE GREY



1180 KITO BLAUSTAHL



5000 FENIX ACCIAIO HAMILTON



5001 FENIX BIANCO



5002 FENIX BIANCO ALASKA



5003 FENIX GRIGIO LONDA

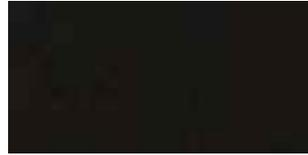

5004 FENIX NERO



5005 FENIX BIANCO KOS



6000 EXTREM CARBON



6001 EXTREM EDELWEISS



6002 EXTREM ICY WHITE



6003 EXTREM KASHMIRGRAU



6008 EXTREM MAGNOLIENWEISS

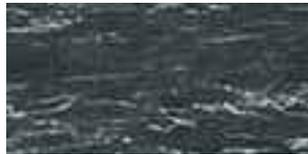

6009 EXTREM MARMOR SCHWARZ



6010 EXTREM MARMOR WEISS



6013 EXTREM SHARKY GREY



6014 EXTREM SNOW/KREIDE

Melamine fronts

Matt-Line

High-gloss Line

Foil-wrapped fronts

Wood

Oak-Line

Handles, worktops decors, colour charts and discontinued lines

Worktop decors

Code No.	Decor	ID	40 mm 40/60/100 mm 16 + 40 mm			Same-coloured front colour	Same-coloured carcasse	Max. length in mm	Same-coloured WAP
			RK	SK	PP				
1000	ALPINWEISS	1025	+	+	+	bianco	bianco	5000	+
1001	ANTHRAZIT SOLID COLOR	1290	-	+	+			4000	+
1002	ARKOSA SAND	276	+	+	+			5000	+
1003	ARLINTON EICHE	H3303	-	+	+	natural knotty oak	natural knotty oak	4000	+
1009	BETON ART PERLGRAU	44375	-	+	+	light oxide		4000	+
1010	BETON DUNKEL	275	+	+	+			5000	+
1011	BÉTON CLAIR	274	+	+	+			5000	+
1012	BETON NATUR	34149	-	+	+			4000	+
1013	BLOCK BOARD NOCHE	4206	+	+	+			5000	+
1015	BORDOLINO EICHE GRAU	1146	+	+	+	oak bardolino		5000	+
1017	CERAMIC ANTHRAZIT	311	+	+	+			5000	+
1018	CERAMICO ROST	6008	+	+	+			5000	+
1019	ANTHRACITE CHROMIX	641	+	+	+			5000	+
1020	CODY WEISS	6259	-	+	+			5000	+
1025	DARK NIGHT	901	-	+	+	black	black	4000	+
1031	CHÉNE SABLE SANREMO	34139	-	+	+	sanremo oak		4000	+
1032	ESCHE MOLINA SAND	1267	+	+	+			5000	+
1033	FLASH BLACK	7654	+	+	+			5000	+
1034	GLADSTONE OAK GREIGE	3326	+	+	+			5000	+
1036	GLITTERSTONE LIGHT	7655	+	+	+			5000	+
1037	GRAPHITGRAU	1257	-	+	+			5000	+
1039	HALIFAX EICHE WEISS	H1176	-		+	halifax white		4000	+
1041	ICY WHITE SOLID COLOR	1027	-	+	+	optiwhite	optiwhite	4000	+
1043	JURAMARMOR	6442	+	+	+			5000	+
1046	KRISTALLWEISS SOLID COLOR	1026	-	+	+	bianco	bianco	4000	+
1047	KUPFER	3236	+	+	+			5000	+
1049	LICHTGRAU	1188	+	+	+	grigio	grigio	5000	+
1053	METALLO GRAUBRAUN	633	+	+	+			5000	+
1054	METALLSCHWARZ	1233	+	+	+	graphite	graphite	5000	+
1060	NATURAL LANCELOT OAK	4263	+	+	+	sherwood nature		5000	+
1062	NEGRO BRASIL	6216	-	+	+			5000	+
1068	PALE LANCELOT OAK	4262	+	+	+			5000	+
1069	PAPYRUS NUBIA BRAUN	22008	+	+	+			5000	+
1072	RAJA BLACK	3505	+	+	+			5000	+
1077	SANDGRAU	1184	+	+	+			5000	+
1095	TIVOLI	6244	+	+	+			5000	+
1100	VICENZA EICHE HELL	H3157	-	+	+	vicenza oak claire	vicenza oak claire	4000	+
1104	WEISS STEINSTRUKTUR	0179	-	+	+	optiwhite	optiwhite	5000	+
1107	DOLPHIN	U12044	-	+	+	dolphin	dolphin	5000	+
1108	SLATE	U12986	-	+	+	slate	slate	5000	+
1109	HALIFAX EICHE NATUR	H1180	-	+	+	halifax nature		5000	+
1110	CRUSH GOLD	F442	-	+	+	crush gold		5000	+
1111	HALIFAX CRACK OAK	H3183	-	+	+	halifax crack oak	halifax crack oak	5000	+
1150	CARBON	U201	-	+	+	carbon	carbon	5000	+
1160	PEBBLE GREY	U968	-	+	+	pebble-grey	pebble-grey	5000	+
1180	KITO BLAUSTAHL	FG76111	-	+	+	steel blue		5000	+

FENIX-Decors

5000	FENIX ACCIAIO HAMILTON	5000	-	+	FE			4000	+
5001	FENIX BIANCO	29	-	+	FE	bianco	bianco	4000	+
5002	FENIX BIANCO ALASKA	30	-	+	FE	optiwhite	optiwhite	4000	+
5003	FENIX GRIGIO LONDA	718	-	+	FE	londra		4000	+
5004	FENIX NERO	720	-	+	FE	black	black	4000	+
5005	FENIX BIANCO KOS	0032	-	+	FE	kos white	bianco	4000	+

Worktop decors

Code No.	Decor	ID	40 mm RK	40/60/100 mm SK	16 + 40 mm PP	Same-coloured front colour	Same-coloured carcase	Max. length in mm	Same-coloured WAP
EXTREM-Decors									
6000	EXTREM CARBON	U1233 XM	-	+	XM	graphite	graphite	4000	+
6001	EXTREM EDELWEISS	SR209 XM	-	+	XM			4000	+
6002	EXTREM ICY WHITE	U1027 XM	-	+	XM	optiwhite	optiwhite	4000	+
6003	EXTREM KASHMIRGRAU	U1168 XM	-	+	XM	cashmere	cashmere	4000	+
6008	EXTREM MAGNOLIENWEISS	U1379 XM	-	+	XM	magnolia	magnolia	4000	+
6009	EXTREM MARMOR SCHWARZ	S63028	-	+	XM	sharky	sharky	4000	+
6010	EXTREM MARMOR WEISS	S63009	-	+	XM			4000	+
6013	EXTREM SHARKY GREY	U091 XM	-	+	XM			4000	+
6014	EXTREM SNOW/KREIDE	U102 XM	-	+	XM	snow	snow	4000	+

FE Fenix HPL (special pricing, see price-list), PP PP-edge, RK radiused edge, SK HPL edge, WAP upstand, XM Extrem HPL (special pricing, see price-list)

XM worktops

- Decorative high-pressure laminate with durable, electron-beam hardened surface and polished reverse side.
- Super-matt texture for the front and worktop with all the quality features and standard values for high-pressure laminate (HPL).
- Comfortably warm, velvety soft feel, inviting touch.
- Impervious to finger and grease marks, for visual appeal in everyday use.
- Optimum ease of cleaning for effortless removal of everyday soiling, above all stubborn grease stains.

Important:

In order to enjoy your XTreme kitchen surfaces for as long as possible, we advise you to observe the following instructions:

- Fine, extra matt surfaces are delicate. The texture itself cannot prevent scratches
- Especially with darker decors mechanical stress can leave behind visible, unsightly marks

Signs of wear, caused for example by unglazed porcelain or cutting on the worktop, do not constitute grounds for complaint.

Colour chart melamine

PREMIUM LINE

KS melamine	Carcase	Vis. side	W 19	WR 19	W 50	W 100	Pilasters	KL/LL	Plinth	Shelving
bianco	KS		•	•	-	•	K	*	•	•
black	KS		•	-	-	-	-	-	•	•
carbon	KS		•	-	•	•	-	-	•	•
dolphin	-	•	•	-	•	•	-	-	•	•
fango	KS		•	-	•	•	-	-	•	•
graphite	KS		•	•	•	•	K	*	•	•
grigio	KS		•	-	•	•	-	-	•	•
cashmere	KS		•	•	•	•	K	*	•	•
pebble-grey	KS		•	-	•	•	-	-	•	•
magnolia	KS		•	•	-	•	K	*	•	•
moss	-	•	•	-	-	•	-	-	•	-
muscata	-	•	•	-	•	•	-	-	•	•
optiwhite	KS		•	-	•	•	-	-	•	•
sharky	KS		•	-	•	•	-	-	•	•
slate	-	•	•	-	•	•	-	-	•	•
snow	KS		•	•	-	•	K	*	•	•

*OZ14/15 OZ36/37 OZ53/54

K Pilaster, foil-wrapped

LITE LINE

KS melamine	Carcase	Vis. side	W 19	WR 19	W 50	W 100	Pilasters	KL/LL	Plinth	Shelving
bianco	-	•	•	-	-	•	-	-	•	•
dolphin	KS		•	-	•	•	-	-	•	•
grigio	-	•	•	-	•	•	-	-	•	•
cashmere	-	•	•	-	•	•	-	-	•	•
pebble-grey	-	•	•	-	•	•	-	-	•	•
moss	-	•	•	-	-	•	-	-	•	-
optiwhite	-	•	•	-	•	•	-	-	•	•
sharky	-	•	•	-	•	•	-	-	•	•
slate	KS		•	-	•	•	-	-	•	•
snow	-	•	•	-	-	•	-	-	•	•

NEW LINE

KS melamine	Carcase	Vis. side	W 19	WR 19	W 50	W 100	Pilasters	KL/LL	Plinth	Shelving
bianco	KS		•	-	-	-	-	-	•	•
carbon	KS		•	-	-	-	-	-	•	•
fango	-	•	•	-	-	-	-	-	•	•
grigio	-	•	•	-	-	-	-	-	•	•
cashmere	-	•	•	-	-	-	-	-	•	•
magnolia	-	•	•	-	-	-	-	-	•	•
muscata	-	•	•	-	-	-	-	-	•	•

PREMIUM LINE

WL Woodline	Carcase	Vis. side	W 19	WR 19	W 50	W 100	Pilasters	KL/LL	Plinth	Shelving
bianco	KS	•	•	-	•	•	-	-	•	•
darkwood	-	•	•	-	-	•	-	-	•	•
denver-oak	-	•	•	-	-	•	-	-	•	-
oak bardolino	-	•	•	-	•	•	-	-	•	•
graphite	KS	•	•	-	•	•	-	-	•	•
natural knotty oak	KS		•	-	•	•	-	-	•	•
nordic	-	•	•	-	•	•	-	-	•	•
sanremo oak	-	•	•	-	•	•	-	-	•	•
stormy oak	-	•	•	-	•	•	-	-	•	•
vicenza oak claire	KS		•	-	•	•	-	-	•	•

Colour chart melamine

LITE LINE

WL Woodline	Carcase	Vis. side	W 19	WR 19	W 50	W 100	Pilasters	KL/LL	Plinth	Shelving
oak bardolino	-	•	•	-	•	•	-	-	•	•
denver-oak	-	•	•	-	-	•	-	-	•	-
natural knotty oak	-	•	•	-	•	•	-	-	•	•
sanremo oak	-	•	•	-	•	•	-	-	•	•
stormy oak	-	•	•	-	•	•	-	-	•	•
vicenza oak claire	-	•	•	-	•	•	-	-	•	•

NEW LINE

WL Woodline	Carcase	Vis. side	W 19	WR 19	W 50	W 100	Pilasters	KL/LL	Plinth	Shelving
bianco	KS	•	•	-	-	-	-	-	•	•
graphite	-	•	•	-	-	-	-	-	•	•
natural knotty oak	-	•	•	-	-	-	-	-	•	•
nordic	-	•	•	-	-	-	-	-	•	•
sanremo oak	-	•	•	-	-	-	-	-	•	•
vicenza oak claire	-	•	•	-	-	-	-	-	•	•

PREMIUM LINE

ST Texture	Carcase	Vis. side	W 19	WR 19	W 50	W 100	Pilasters	KL/LL	Plinth	Shelving
amber (N)	-	•	•	-	-	•	-	-	•	•
argento (N)	-	•	•	-	•	•	-	-	•	•
ash	-	•	•	-	-	•	-	-	•	•
basalt dunkel	-	•	•	-	-	•	-	-	•	•
black (Cemento)	KS	•	•	-	-	•	-	-	•	•
black (Metall)	KS	•	•	-	-	•	-	-	•	•
bronze	-	•	•	-	-	•	-	-	•	•
brown (Metal)	-	•	•	-	-	•	-	-	•	•
halifax crack oak (N)	KS	-	•	-	•	•	-	-	•	•
halifax nature	-	•	•	-	•	•	-	-	•	•
halifax white	-	•	•	-	•	•	-	-	•	•
knotty oak	-	•	•	-	•	•	-	-	•	•
light grey	-	•	•	-	-	•	-	-	•	•
light oxide	-	•	•	-	-	•	-	-	•	•
reno	-	•	•	-	-	•	-	-	•	-
sand	-	•	•	-	-	•	-	-	•	•
sherwood black	KS	•	•	-	-	•	-	-	•	•
sherwood burned wood	-	•	•	-	-	•	-	-	•	-
sherwood bushy park	-	•	•	-	-	•	-	-	•	•
sherwood cigar	-	•	•	-	-	•	-	-	•	•
sherwood engadina	-	•	•	-	-	•	-	-	•	•
sherwood graphite (N)	KS	•	•	-	-	•	-	-	•	•
sherwood greenwich	-	•	•	-	-	•	-	-	•	•
sherwood nature	-	•	•	-	-	•	-	-	•	•
sherwood richmond	-	•	•	-	-	•	-	-	•	•
dark steel	-	•	•	-	-	•	-	-	•	•
steel blue	-	•	•	-	-	•	-	-	•	•
light umbra	-	•	•	-	-	•	-	-	•	•

Colour chart melamine

LITE LINE

ST Texture	Carcase	Vis. side	W 19	WR 19	W 50	W 100	Pilasters	KL/LL	Plinth	Shelving
amber	(N) -	•	•	-	-	•	-	-	•	•
argento	(N) -	•	•	-	•	•	-	-	•	•
ash	-	•	•	-	-	•	-	-	•	•
basalt dunkel	-	•	•	-	-	•	-	-	•	•
black (Metall)	-	•	•	-	-	•	-	-	•	•
brown (Metal)	-	•	•	-	-	•	-	-	•	•
halifax nature	-	•	•	-	•	•	-	-	•	•
halifax white	-	•	•	-	•	•	-	-	•	•
knotty oak	-	•	•	-	•	•	-	-	•	•
light grey	-	•	•	-	-	•	-	-	•	•
light oxide	-	•	•	-	-	•	-	-	•	•
sand	-	•	•	-	-	•	-	-	•	•
sherwood burned wood	-	•	•	-	-	•	-	-	•	-
sherwood bushy park	-	•	•	-	-	•	-	-	•	•
sherwood engadina	-	•	•	-	-	•	-	-	•	•
sherwood graphite	(N) -	•	•	-	-	•	-	-	•	•
sherwood nature	-	•	•	-	-	•	-	-	•	•
dark steel	-	•	•	-	-	•	-	-	•	•
steel blue	-	•	•	-	-	•	-	-	•	•
light umbra	-	•	•	-	-	•	-	-	•	•

NEW LINE

ST Texture	Carcase	Vis. side	W 19	WR 19	W 50	W 100	Pilasters	KL/LL	Plinth	Shelving
basalt dunkel	-	•	•	-	-	-	-	-	•	•
halifax white	-	•	•	-	-	-	-	-	•	•
light grey	-	•	•	-	-	-	-	-	•	•
light oxide	-	•	•	-	-	-	-	-	•	•

PREMIUM LINE

ES Stainless steel	Carcase	Vis. side	W 19	WR 19	W 50	W 100	Pilasters	KL/LL	Plinth	Shelving
stainless steel	-	-	-	-	-	-	-	-	•	-

PREMIUM LINE

UM Ultra matt	Carcase	Vis. side	W 19	WR 19	W 50	W 100	Pilasters	KL/LL	Plinth	Shelving
bianco	KS	•	•	-	-	•	-	-	•	•
magnolia	KS	•	•	-	-	•	-	-	•	•
snow	KS	•	•	-	-	•	-	-	•	•

LITE LINE

UM Ultra matt	Carcase	Vis. side	W 19	WR 19	W 50	W 100	Pilasters	KL/LL	Plinth	Shelving
bianco	-	•	•	-	-	•	-	-	•	•
snow	-	•	•	-	-	•	-	-	•	•

NEW LINE

UM Ultra matt	Carcase	Vis. side	W 19	WR 19	W 50	W 100	Pilasters	KL/LL	Plinth	Shelving
bianco	KS	•	•	-	-	-	-	-	•	•
magnolia	-	•	•	-	-	-	-	-	•	•

Colour chart Matt-Line

PREMIUM LINE

SM HPL matt	Carcase	Vis. side	W 19	WR 19	W 50	W 100	Pilasters	KL/LL	Plinth	Shelving
bianco	KS	•	•	-	•	•	-	-	•	•
kos white	KS	•	•	-	•	•	-	-	•	•
magnolia	KS	•	•	-	•	•	-	-	•	•
optiwhite	KS	•	•	-	•	•	-	-	•	•

LITE LINE

SM HPL matt	Carcase	Vis. side	W 19	WR 19	W 50	W 100	Pilasters	KL/LL	Plinth	Shelving
bianco	-	•	•	-	•	•	-	-	•	•
optiwhite	-	•	•	-	•	•	-	-	•	•

NEW LINE

SM HPL matt	Carcase	Vis. side	W 19	WR 19	W 50	W 100	Pilasters	KL/LL	Plinth	Shelving
bianco	KS	•	•	-	-	-	-	-	•	•
magnolia	-	•	•	-	-	-	-	-	•	•

PREMIUM LINE

SMF Fenix	Carcase	Vis. side	W 19	WR 19	W 50	W 100	Pilasters	KL/LL	Plinth	Shelving
bianco	KS	•	•	-	•	-	-	-	•	-
black	KS	•	•	-	•	-	-	-	•	-
bromo	-	•	•	-	•	-	-	-	•	-
cacao	-	•	•	-	•	-	-	-	•	-
lightgrey	-	•	•	-	•	-	-	-	•	-
kos white	KS	•	•	-	•	-	-	-	•	-
londra	-	•	•	-	•	-	-	-	•	-
midnight blue	-	•	•	-	•	-	-	-	•	-
optiwhite	KS	•	•	-	•	-	-	-	•	-
rosso	-	•	•	-	•	-	-	-	•	-
verde	-	•	•	-	•	-	-	-	•	-
cement white	-	SZ	SZ	-	SZ	SZ	-	-	SZ	-

SZ HPL soft cement

PREMIUM LINE

XTR Xtreme	Carcase	Vis. side	W 19	WR 19	W 50	W 100	Pilasters	KL/LL	Plinth	Shelving
black	KS	•	•	-	•	•	-	-	•	-
graphite	KS	•	•	-	•	•	-	-	•	-
cashmere	KS	•	•	-	•	•	-	-	•	-
optiwhite	KS	•	•	-	•	•	-	-	•	-
sharky	KS	•	•	-	•	•	-	-	•	-
snow	KS	•	•	-	•	•	-	-	•	-

PREMIUM LINE

MT - Metallic	Carcase	Vis. side	W 19	WR 19	W 50	W 100	Pilasters	KL/LL	Plinth	Shelving
bronze oxide	-	•	•	-	-	•	-	-	•	-
copper	-	•	•	-	-	•	-	-	•	-
gold	-	•	•	-	-	•	-	-	•	-
platinum	-	•	•	-	-	•	-	-	•	-

Colour chart Matt-Line

PREMIUM LINE

ACM - Acrylic matt	Carcase	Vis. side	W 19	WR 19	W 50	W 100	Pilasters	KL/LL	Plinth	Shelving
terricio	-	•	•	-	-	-	-	-	•	-
titanio	-	•	•	-	-	-	-	-	•	-

PREMIUM LINE

ML Matt lacquered	Carcase	Vis. side	W 19	WR 19	W 50	W 100	Pilasters	KL/LL	Plinth	Shelving
snow	KS	•	•	-	•	-	-	-	•	-
RAL/Sikkens/NCS colours	-	•	•	-	•	-	-	-	•	-

ML matt lacquered models can also be combined with accessory components in SM matt laminate or UM ultra-matt.

LITE LINE

ML Matt lacquered	Carcase	Vis. side	W 19	WR 19	W 50	W 100	Pilasters	KL/LL	Plinth	Shelving
snow	-	•	•	-	•	-	-	-	•	-

PREMIUM LINE

MLMi Micron-textured lacquer	Carcase	Vis. side	W 19	WR 19	W 50	W 100	Pilasters	KL/LL	Plinth	Shelving
bianco	KS	•	•	•	•	-	-	-	•	-
black	KS	•	•	•	•	-	-	-	•	-
blue grey	-	•	•	•	•	-	-	-	•	-
graphite	KS	•	•	•	•	-	-	-	•	-
midnight blue	-	•	•	•	•	-	-	-	•	-
peach	-	•	•	•	•	-	-	-	•	-
rust	-	•	•	•	•	-	-	-	•	-
sharky	KS	•	•	•	•	-	-	-	•	-
snow	KS	•	•	•	•	-	-	-	•	-
fir green	-	•	•	•	•	-	-	-	•	-
taupe	-	•	•	•	•	-	-	-	•	-
RAL/Sikkens/NCS colours	-	•	•	•	•	-	-	-	•	-

PREMIUM LINE

MLSO Matt lacquered/Soft	Carcase	Vis. side	W 19	WR 19	W 50	W 100	Pilasters	KL/LL	Plinth	Shelving
bianco	KS	•	•	•	•	-	-	-	•	-
black	KS	•	•	•	•	-	-	-	•	-
carbon	KS	•	•	•	•	-	-	-	•	-
graphite	KS	•	•	•	•	-	-	-	•	-
cashmere	KS	•	•	•	•	-	-	-	•	-
pebble-grey	KS	•	•	•	•	-	-	-	•	-
londra	-	•	•	•	•	-	-	-	•	-
magnolia	KS	•	•	•	•	-	-	-	•	-
marone ^(N)	-	•	•	•	•	-	-	-	•	-
midnight blue	-	•	•	•	•	-	-	-	•	-
moss	-	•	•	•	•	-	-	-	•	-
olive	-	•	•	•	•	-	-	-	•	-
seta ^(N)	-	•	•	•	•	-	-	-	•	-
fir green	-	•	•	•	•	-	-	-	•	-
urbano ^(N)	-	•	•	•	•	-	-	-	•	-

Colour chart Matt-Line

PREMIUM LINE

UVM Matt lacquered	Carcase	Vis. side	W 19	WR 19	W 50	W 100	Pilasters	KL/LL	Plinth	Shelving	
anthracite	-	•	•	-	-	-	-	-	•	-	KS* only unicolour, like carcase
aqua (N)	-	•	•	-	-	-	-	-	•	-	
bianco	KS	•	•	-	-	-	-	-	•	KS*	
black (N)	KS	•	•	-	-	-	-	-	•	KS	
carbon	KS	•	•	-	-	-	-	-	•	KS*	
crush gold	-	•	•	-	-	-	-	-	•	-	
dolphin	-	•	•	-	-	-	-	-	•	KS*	
fango	KS	•	•	-	-	-	-	-	•	KS*	
cashmere	KS	•	•	-	-	-	-	-	•	KS*	
pebble-grey	KS	•	•	-	-	-	-	-	•	KS*	
laguna (N)	-	•	•	-	-	-	-	-	•	-	
ocean	-	•	•	-	-	-	-	-	•	-	
slate	-	•	•	-	-	-	-	-	•	KS*	
snow (N)	KS	•	•	-	-	-	-	-	•	KS	
steel gold-brown	-	•	•	-	-	-	-	-	•	-	

LITE LINE

UVM Matt lacquered	Carcase	Vis. side	W 19	WR 19	W 50	W 100	Pilasters	KL/LL	Plinth	Shelving	
anthracite	-	•	•	-	-	-	-	-	•	-	KS* only unicolour, like carcase
aqua (N)	-	•	•	-	-	-	-	-	•	-	
bianco	-	•	•	-	-	-	-	-	•	KS*	
black (N)	-	•	•	-	-	-	-	-	•	KS*	
carbon	-	•	•	-	-	-	-	-	•	KS*	
crush gold	-	•	•	-	-	-	-	-	•	-	
dolphin	KS	•	•	-	-	-	-	-	•	KS*	
fango	-	•	•	-	-	-	-	-	•	KS*	
cashmere	-	•	•	-	-	-	-	-	•	KS*	
pebble-grey	-	•	•	-	-	-	-	-	•	KS*	
laguna (N)	-	•	•	-	-	-	-	-	•	-	
ocean	-	•	•	-	-	-	-	-	•	-	
slate	KS	•	•	-	-	-	-	-	•	KS*	
snow (N)	-	•	•	-	-	-	-	-	•	KS*	
steel gold-brown	-	•	•	-	-	-	-	-	•	-	

PREMIUM LINE

LM Lacquered metal look	Carcase	Vis. side	W 19	WR 19	W 50	W 100	Pilasters	KL/LL	Plinth	Shelving
bronze dark	-	•	•	-	•	•	-	-	•	-
bronze light	-	•	•	-	•	•	-	-	•	-
silver	-	•	•	-	•	•	-	-	•	-
titanium	-	•	•	-	•	•	-	-	•	-

PREMIUM LINE

BT Concrete	Carcase	Vis. side	W 19	WR 19	W 50	W 100	Pilasters	KL/LL	Plinth	Shelving
clair-light	-	•	•	-	•	•	-	-	•	-
fonce-dark	-	•	•	-	•	•	-	-	•	-
moyen-medium	-	•	•	-	•	•	-	-	•	-
super-bright	-	•	•	-	•	•	-	-	•	-

Colour chart High-gloss Line

PREMIUM LINE

EG Fine gloss	Carcase	Vis. side	W 19	WR 19	W 50	W 100	Pilasters	KL/LL	Plinth	Shelving
bianco	KS	•	•	-	•	•	-	-	•	•
cashmere	KS	•	•	-	•	•	-	-	•	•
optiwhite	KS	•	•	-	•	•	-	-	•	•

LITE LINE

EG Fine gloss	Carcase	Vis. side	W 19	WR 19	W 50	W 100	Pilasters	KL/LL	Plinth	Shelving
bianco	-	•	•	-	•	•	-	-	•	•
cashmere	-	•	•	-	•	•	-	-	•	•
optiwhite	-	•	•	-	•	•	-	-	•	•

NEW LINE

EG Fine gloss	Carcase	Vis. side	W 19	WR 19	W 50	W 100	Pilasters	KL/LL	Plinth	Shelving
bianco	KS	•	•	-	-	-	-	-	•	•
cashmere	-	•	•	-	-	-	-	-	•	•
optiwhite	-	•	•	-	-	-	-	-	•	•

PREMIUM LINE

SG HPL gloss	Carcase	Vis. side	W 19	WR 19	W 50	W 100	Pilasters	KL/LL	Plinth	Shelving
bianco	KS	•	•	-	•	•	-	-	•	•
grigio	KS	•	•	-	•	•	-	-	•	•
magnolia	KS	•	•	-	•	•	-	-	•	•
optiwhite	KS	•	•	-	•	•	-	-	•	•
snow	KS	•	•	-	•	•	-	-	•	•

LITE LINE

SG HPL gloss	Carcase	Vis. side	W 19	WR 19	W 50	W 100	Pilasters	KL/LL	Plinth	Shelving
bianco	-	•	•	-	•	•	-	-	•	•
magnolia	-	•	•	-	•	•	-	-	•	•
optiwhite	-	•	•	-	•	•	-	-	•	•
snow	-	•	•	-	•	•	-	-	•	•

NEW LINE

SG HPL gloss	Carcase	Vis. side	W 19	WR 19	W 50	W 100	Pilasters	KL/LL	Plinth	Shelving
bianco	KS	•	•	-	-	-	-	-	•	•
grigio	-	•	•	-	-	-	-	-	•	•
optiwhite	-	•	•	-	-	-	-	-	•	•
snow	-	•	•	-	-	-	-	-	•	•

PREMIUM LINE

LG High-gloss lacquered	Carcase	Vis. side	W 19	WR 19	W 50	W 100	Pilasters	KL/LL	Plinth	Shelving
bianco	KS	•	•	-	•	-	-	-	•	SG
snow	KS	•	•	-	•	-	-	-	•	SG
RAL/Sikkens/NCS colours	-	•	•	-	•	-	-	-	•	-

LG high-gloss lacquered models can also be combined with visible sides, panels, etc. in SG HPL gloss.

LITE LINE

LG High-gloss lacquered	Carcase	Vis. side	W 19	WR 19	W 50	W 100	Pilasters	KL/LL	Plinth	Shelving
bianco	-	•	•	-	•	-	-	-	•	SG
snow	-	•	•	-	•	-	-	-	•	SG

LG high-gloss lacquered models can also be combined with visible sides, panels, etc. in SG HPL gloss.

PREMIUM LINE

ACG - Acrylic glossy	Carcase	Vis. side	W 19	WR 19	W 50	W 100	Pilasters	KL/LL	Plinth	Shelving
bianco	KS	•	•	-	-	-	-	-	•	-
black	KS	•	•	-	-	-	-	-	•	-
fumo	-	•	•	-	-	-	-	-	•	-
cashmere	KS	•	•	-	-	-	-	-	•	-
snow	KS	•	•	-	-	-	-	-	•	-

Colour chart wood

PREMIUM LINE

FL Veneer lacquered	Carcase	Vis. side	W 19	WR 19	W 50	W 100	Pilasters	Country Style	KL/LL	Plinth	Shelving	M Square pilasters
bianco	KS	•	•	•	•	•	M	•	40/41	•	•	
black	KS	•	•	•	•	•	M	•	40/41	•	•	
graphite	KS	•	•	•	•	•	M	•	40/41	•	•	
magnolia	KS	•	•	•	•	•	M	•	40/41	•	•	
RAL/Sikkens/NCS colours	-	•	•	•	•	•	M	•	40/41	•	•	

Colour chart Oak-Line

PREMIUM LINE

FA Anticato, brushed or sandblasted	Carcase	Vis. side	Panels	Panels+grooves	Plinth	Shelving
beachwood	-	•	•	•	•	•
bianco	KS	•	•	•	•	•
black	KS	•	•	•	•	•
chalk	-	•	•	-	•	•
driftwood	-	•	•	•	•	•
chestnut	KS	•	•	•	•	•
kastanie	-	•	•	•	•	•
loam	-	•	•	•	•	•
natural knotty oak	-	•	•	•	•	•
nature	-	•	•	-	•	•
real-nature	-	•	W19	-	•	•
tiramisu	-	•	W19	-	•	•
RAL/Sikkens/NCS colours	-	•	•	•	•	•

PREMIUM LINE

FR Veneer Anticato (Rough/Intense)	Carcase	Vis. side	Panels	Panels+grooves	Plinth	Shelving
black	KS	•	•	•	•	-
black (Notcho) (N)	KS	•	•	•	•	-
graphitee	KS	•	•	•	•	-
nature	-	•	•	•	•	-
nature (Notcho) (N)	-	•	•	•	•	-
pastell loam	-	•	•	•	•	-
pastell shadow	-	•	•	•	•	-
pastell smoke	-	•	•	•	•	-
plage	-	•	•	•	•	-
walnut (Notcho) (N)	-	•	•	•	•	-

Discontinued lines 2021

PREMIUM LINE

Doors			
ARTE LG optiwhite	CADRE loam	CALM complete	CASELLA complete
CROSS curio	ESPRIT fango	ESPRIT muscata	FENIX steel H/V
FROST muscata	INCAVO beachwood	INCAVO black	INCAVO loam
INCAVO magnolia	INCAVO sanremo oak	INTENSE black	INTENSE tobacco
LATINI complete	LUCE gris	LUCE muscata	LUCE COLORED complete
LUCE INFINITY gris	LUNA MICRON fango	LUNA MICRON grigio	LUNA MICRON cashmere
LUNA MICRON magnolia	LUNA MICRON muscata	LUNA MICRON optiwhite	MARBLE marm. anthracite
MARBLE marm. Bianco	MARBLE marm. Black	MERINO magnolia	MERINO sanremo oak
OPACO brown	OPACO grigio	OPACO magnolia	ORBITA black
ORBITA loam	ORBITA sanremo oak	POWDER complete	RIPIENO bianco
RIPIENO black	RIPIENO sanremo oak	SOLCO complete	STRETTO loam
TELAIO beachwood	TELAIO black	TELAIO loam	TELAIO magnolia
TELAIO sanremo oak	TREND 8 complete		

Note:
The discontinued models listed are available up to the end of December 2021!

Carcase colours	
eiche bardolino 030	sanremo oak 046

Discontinued lines 2021

LITE LINE

Doors			
ARTE LG optiwhite	CALM complete	LUCE COLORED complete	OPACO brown
OPACO grigio	OPACO magnolia		

Note:
The discontinued models listed are available up to the end of December 2021!

Discontinued lines 2021

NEW LINE

Doors			
CALM complete	FROST muscata	LUCE gris	LUCE INFINITY gris
LUCE COLORED complete			

Note:
The discontinued models listed are available up to the end of December 2021!

Discontinued lines 2021

PREMIUM LINE + LITE LINE + NEW LINE

Handles			
276	280	288	317
387	431/432	450	STG in all heights

Worktops			
1007 BELMONT GRAU	1008 BETON	1040 HARBOUR BRIDGE	1051 MARMOR 4 SCHWARZ
1059 MYKONOS	1063 NERO TERRA BRAUN	1067 ONYX BLACK	1096 TORTONA NATURE
1105 WELLINGTON OAK			

Schröder Küchen GmbH & Co. KG

Oeppings Brink 7 – D-32278 Kirchlengern
Fon +49 (0) 52 23 / 97 35-0 – Fax +49 (0) 52 23 / 97 35-35/-341
info@schroeder-kuechen.de – www.schroeder-kuechen.de