



à la  
**carte**  
2023

Premium  
Lite Line  
New Line

# Contents

Carcase.....	2
Visible sides.....	3 - 5
Heights of carcase and fronts.....	6 - 12
Glass.....	13
Blum LEGRABOX / TANDEMBOX-ANTARO.....	14 - 15
Blum TANDEMBOX-PLUS.....	16
<b>Melamine fronts</b>	
TOUCH / TOUCH com.....	18 - 19
PORTO H/V w/ / PORTO H/V w/ com.....	20
ALBERO H/V / ALBERO H/V com.....	21
SINCRONO H/V / SINCRONO H/V com.....	22 - 23
SHERWOOD H/V / SHERWOOD H/V com.....	24
SMART H/V / SMART H/V com.....	25
CEMENTO / CEMENTO com.....	26
METALL H/V / METALL H/V com.....	27
STYLE.....	28
<b>Matt-Line</b>	
FEELWOOD H/V / FEELWOOD H/V com.....	30
FROST / FROST com.....	31
OPACO / OPACO com.....	32
EXTREM / EXTREM com, URBAN / URBAN com.....	33
POMP.....	34
FENIX / FENIX com, ART-GLAS MATT.....	35
EFFECTO / EFFECTO com, CONCRETE.....	36
LUNA R2 / LUNA R2 com.....	37
LUNA R2 RAL / LUNA R2 RAL com.....	37
LUNA MICRON / LUNA MICRON com.....	38
LUNA SOFT / LUNA SOFT com.....	39
INSPIRATION SOFT.....	40
ELEGANCE SOFT.....	41
MILA SOFT.....	42
<b>High-gloss Line</b>	
SILK / SILK com.....	44
ESPRIT / ESPRIT com.....	45
LUCE / LUCE com.....	46
LUCE INFINITY / LUCE INFINITY com.....	47
PASSION / PASSION com.....	48
PASSION R2 RAL.....	48
LUCIDA / LUCIDA com.....	49
ART-GLAS GLOSS.....	50
<b>Foil-wrapped fronts</b>	
GROOVE matt.....	52
CASTLE matt, MEDA matt.....	53
MODERNO matt.....	54
<b>Wood Range + Wood Specials</b>	
WOOD RANGE + SPECIALS Overview.....	56 - 57
MERINO H/V.....	58 - 59
SPLIT PLANK-OAK V, SPLIT OAK H/V.....	60
LAMELLA.....	61
CADRE.....	62
TELAIO.....	63
STRETTO.....	64
TOSCANA.....	65
ROUGH zero + R15.....	66
REAL-OAK H/V.....	67
VERTICO V.....	68
BLACK STRIPE V, BLACK-LINE.....	69
NOTCHO, ORBITA.....	70
RIPIENO.....	71
<b>Handles, worktop decors, colour charts, conversion table and discontinued lines</b>	
Handles.....	73 - 77
Worktop decors.....	78 - 81
Colour charts.....	81 - 90
Conversion table.....	90
Discontinued lines 2022.....	91

# Legend

<b>N</b>	NEW
<b>GL</b>	Handleless (flatdoor)
<b>GLD E/B</b>	Handleless decOR (flatdoor), profile stainless steel or black
<b>GLV E/B</b>	Handleless (door with 45° chamfer + metal-strip) metal-strip stainless steel or black
<b>GLXE</b>	Handleless (door with 90° routing + stainless steel strip)
<b>GLV 45</b>	Handleless (door with 45° chamfer)
<b>GLX 90</b>	Handleless (door with 90° routing)
<b>GLU</b>	Handleless (wooden door with U-routing)
<b>ELarge</b>	Extra-large, crockery cabinets with one-piece full-height doors can be supplied up to 195 cm high in <b>wood decor</b> , and up to 234 cm in <b>unicolours</b>
<b>EWide</b>	Extra-wide pull-outs and flaps available as a special size up to max. 180 cm
<b>XTend</b>	Tall unit fronts available with full-height doors (without filler panels)
<b>COM</b>	Range available with <b>COM strip rounded 996</b> , square <b>994 + 997</b> and down <b>995</b>
<b>CLA</b>	Some appliance housing units require a different front layout (see price list) for the COM ranges

## Carcase

<b>KS</b>	Carcase inside and outside in colour
*	to choice, no carcass in front colour available

## Visible sides

**if required, please specify when ordering!**  
(Wood decors always with vertical graining)









-	none required
<b>KS</b>	Melamine
<b>WL</b>	Woodline
<b>ST</b>	Texture
<b>UM</b>	Ultra-matt
<b>SM</b>	HPL matt
<b>SMF</b>	HPL matt Fenix
<b>XTR</b>	HPL matt Extrem
<b>SZ</b>	HPL soft cement
<b>UVM</b>	UV matt lacquered
<b>ACM</b>	Acryl matt
<b>ML</b>	Matt lacquered
<b>MLMI</b>	Matt lacquered Micron
<b>MLSO</b>	Matt lacquered Soft
<b>BT</b>	Concrete
<b>LM</b>	Lacquered metal look
<b>EG</b>	Fine gloss
<b>SG</b>	HPL gloss
<b>ACG</b>	Acryl gloss
<b>UVHG</b>	UV high gloss
<b>LG</b>	High-gloss lacquered
<b>F1</b>	knotty raw (strong veneer, knotty with figure, blasted)
<b>F2</b>	knotty brushed (knotty veneer with figure, brushed)
<b>F3</b>	striped brushed (plain Veneer without figure, brushed)
<b>F4</b>	silky smart (silky gloss finish)

## Panels

-	not available
<b>KS</b>	Melamine*
<b>WL</b>	Woodline
<b>ST</b>	Texture
<b>UM</b>	Ultra-matt
<b>SM</b>	HPL matt
<b>SMF</b>	HPL matt Fenix*
<b>XTR</b>	HPL matt Extrem*
<b>SZ</b>	HPL soft cement
<b>UVM</b>	UV matt lacquered
<b>ACM</b>	Acryl matt
<b>ML</b>	Matt lacquered
<b>MLMI</b>	Matt lacquered Micron
<b>MLSO</b>	Matt lacquered Soft
<b>BT</b>	Concrete
<b>LM</b>	Lacquered metal look
<b>EG</b>	Fine gloss
<b>SG</b>	HPL gloss
<b>ACG</b>	Acryl gloss

<b>UVHG</b>	UV high gloss
<b>LG</b>	High-gloss lacquered
<b>F1</b>	knotty raw (strong veneer, knotty with figure, blasted)
<b>F2</b>	knotty brushed (knotty veneer with figure, brushed)
<b>F3</b>	striped brushed (plain Veneer without figure, brushed)
<b>F4</b>	silky smart (silky gloss finish)

## Cornice / Light pelmet

<b>OZ 14</b>	 Light pelmet melamine or matt lacquered
<b>OZ 15</b>	 Cornice melamine or matt lacquered
<b>OZ 36</b>	 Light pelmet melamine or matt lacquered
<b>OZ 37</b>	 Cornice melamine or matt lacquered
<b>OZ 40</b>	 Light pelmet mit Holzstruktur, lackiert (F4)
<b>OZ 41</b>	 Kranzleiste mit Holzstruktur, lackiert (F4)
<b>OZ 53</b>	 Cornice melamine or matt lacquered
<b>OZ 54</b>	 Light pelmet melamine or matt lacquered

## Pilasters (Shaker)

<b>K</b>	Pilaster, foil-wrapped
<b>M</b>	Pilaster solid square, lacquered

## Plinth panels

**When ordering, please specify if a surface other than KS is required!** (Wood decors always horizontal graining)

-	not available
<b>KS</b>	Melamine
<b>WL</b>	Woodline horizontal (max. 260 cm)
<b>ST</b>	Texture horizontal (max. 260 cm)
<b>UM</b>	Ultra-matt (max. 260 cm)
<b>SM</b>	HPL matt
<b>SMF</b>	HPL matt Fenix
<b>XTR</b>	HPL matt Extrem
<b>SZ</b>	HPL soft cement
<b>UVM</b>	UV matt lacquered
<b>ACM</b>	Acryl matt
<b>ML</b>	Matt lacquered
<b>MLMI</b>	Matt lacquered Micron
<b>MLSO</b>	Matt lacquered Soft
<b>BT</b>	Concrete (max. 250 cm)
<b>LM</b>	Lacquered metal look
<b>EG</b>	Fine gloss (max. 260 cm)
<b>SG</b>	HPL gloss
<b>ACG</b>	Acryl gloss
<b>UVHG</b>	UV high gloss
<b>LG</b>	High-gloss lacquered
<b>F1</b>	knotty raw (strong veneer, knotty with figure, blasted)
<b>F2</b>	knotty brushed (knotty veneer with figure, brushed)
<b>F3</b>	striped brushed (plain Veneer without figure, brushed)
<b>F4</b>	silky smart (silky gloss finish)

## Open shelving

**When ordering, please specify if a surface other than KS is required!** (Wood decors always with vertical graining)

-	Colour not available
<b>KS</b>	Melamine*
<b>WL</b>	Woodline
<b>ST</b>	Texture
<b>UM</b>	Ultra-matt
<b>SM</b>	HPL matt
<b>EG</b>	Fine gloss
<b>SG</b>	HPL gloss
<b>F2</b>	knotty brushed (knotty veneer with figure, brushed)
<b>F3</b>	striped brushed (plain Veneer without figure, brushed)
<b>F4</b>	silky smart (silky gloss finish)

## Carcase finishes

PREMIUM LINE

Carcase as standard in same decor inside and outside with PP edging



bianco 006



black 008



carbon 063



dolphin 123



graphite 017



grigio 095



halifax crack oak 199



cashmere 024



pebble-grey 064



magnolia 090



natural knotty oak 028



optiwhite 007



orion 243



sharky 126



shell 244



slate 128



snow 101



walnut 216

All wood decors with textured surface (WL/ST)



## Carcase finishes

LITE LINE

Carcase as standard in same decor inside and outside with PP edging



bianco 006



carbon 063



dolphin 123



slate 128



## Carcase finishes

NEW LINE

Carcase as standard in same decor inside and outside with PP edging



bianco 006



carbon 063



dolphin 123



slate 128



If the carcass is ordered with a visible side, please keep in mind that its edge comes in the colour of the visible side. All other edges are displayed in the ordered carcass colour. Due to the characteristics of a wooden material, the colours of a visible side can deviate slightly from the colour play of the displayed door style.

## VISIBLE SIDES AT NO EXTRA CHARGE

VISIBLE SIDE:	CARCASE:	VISIBLE SIDE:	CARCASE:	VISIBLE SIDE:	CARCASE:
<b>KS melamine</b>		<b>WL Woodline</b>		<b>EG Fine gloss</b>	
arcai-red	(N) to choice	bianco	bianco	bianco	bianco
blackblue	(N) to choice	black burned	(N) to choice	cashmere	cashmere
blackgreen	(N) to choice	denver-oak	to choice	optiwhite	optiwhite
fango	to choice	oak bardolino	to choice	<b>UM Melamine ultra-matt</b>	
moss	to choice	sanremo oak	to choice	bianco	bianco
muscata	to choice	vicenza oak claire	to choice	magnolia	magnolia
stormgrey	(N) to choice			snow	snow

## VISIBLE SIDES AT EXTRA CHARGE

VISIBLE SIDE:	CARCASE:	VISIBLE SIDE:	CARCASE:	VISIBLE SIDE:	CARCASE:
<b>ST Texture</b>		<b>SMF HPL matt Fenix</b>		<b>MLMi - Matt lacquered Micron</b>	
amber	to choice	midnight blue	to choice	fir green	to choice
argento	to choice	optiwhite	optiwhite	urbano	to choice
basalt dunkel	to choice	rosso	to choice	RAL/Sikkens/NCS colours	to choice
black (Albero)	(N) black	verde	to choice	<b>MLSO - Matt lacquered Soft</b>	
black (Cemento)	black	<b>SZ HPL soft cement</b>		bianco	bianco
black (Feelwood)	(N) black	cement white	to choice	black	black
black (Metall)	black	<b>BT Concrete</b>		carbon	carbon
bronze	to choice	clair-light	to choice	graphite	graphite
brown (Metall)	to choice	fonce-dark	to choice	cashmere	cashmere
coffee	(N) to choice	moyen-medium	to choice	pebble-grey	pebble-grey
halifax nature	to choice	super-bright	to choice	londra	to choice
halifax tin dark	(N) to choice	<b>UVM Matt lacquered</b>		marone	to choice
halifax white	to choice	aqua	to choice	midnight blue	to choice
knotty oak	to choice	bianco	bianco	moos	to choice
light grey	to choice	black	black	olive	to choice
nature	(N) to choice	carbon	carbon	orion	(N) orion
noce	(N) to choice	crush gold	to choice	seta	to choice
light oxide	to choice	dolphin	dolphin	shell	(N) shell
sherwood black	black	fango	to choice	snow	(N) snow
sherwood burned wood	to choice	cashmere	cashmere	fir green	to choice
sherwood bushy park	to choice	pebble-grey	pebble-grey	urbano	to choice
sherwood cigar	to choice	laguna	to choice	<b>LM Lacquered metal look</b>	
sherwood engadina	to choice	ocean	to choice	bronze dark	to choice
sherwood graphite	graphite	slate	slate	bronze light	to choice
sherwood greenwich	to choice	snow	snow	silver	to choice
sherwood nature	to choice	steel gold-brown	to choice	titanium	to choice
dark steel	to choice	<b>ML - Matt lacquered</b>		<b>ACM - Acrylic matt</b>	
steel blue	to choice	copper	(N) to choice	aureo	to choice
light umbra	to choice	copper crumble	(N) to choice	bianco	bianco
<b>XTR HPL matt Extrem</b>		gold	(N) to choice	black	black
black	black	gold crumble	(N) to choice	graphite	graphite
graphite	graphite	snow	snow	luminoso	to choice
optiwhite	optiwhite	RAL/Sikkens/NCS colours	to choice	opale	to choice
orion	(N) orion	<b>MLMi - Matt lacquered Micron</b>		snow	snow
shell	(N) shell	bianco	bianco	terricio	to choice
snow	snow	black	black	titanio	to choice
<b>SM HPL matt</b>		carbon	carbon	<b>SG HPL gloss</b>	
bianco	bianco	graphite	graphite	bianco	bianco
magnolia	magnolia	cashmere	cashmere	magnolia	magnolia
optiwhite	optiwhite	pebble-grey	pebble-grey	optiwhite	optiwhite
shell	(N) shell	londra	to choice	snow	snow
<b>SMF HPL matt Fenix</b>		marone	to choice	<b>LG High-gloss lacquered</b>	
bianco	bianco	midnight blue	to choice	bianco	bianco
black	black	moos	to choice	snow	snow
bromo	to choice	olive	to choice	RAL/Sikkens/NCS colours	to choice
cacao	to choice	orion	(N) orion	<b>UVHG Lacquer high-gloss</b>	
light grey	to choice	seta	to choice	bianco	bianco
kos white	bianco	shell	(N) shell	grigio	(N) grigio
londra	to choice	snow	(N) snow		

## Visible sides

## PREMIUM LINE

If the carcass is ordered with a visible side, please keep in mind that its edge comes in the colour of the visible side. All other edges are displayed in the ordered carcass colour. Due to the characteristics of a wooden material, the colours of a visible side can deviate slightly from the colour play of the displayed door style.

### VISIBLE SIDES AT EXTRA CHARGE

VISIBLE SIDE:	CARCASS:	VISIBLE SIDE:	CARCASS:	VISIBLE SIDE:	CARCASS:
<b>UVHG Lacquer high-gloss</b>					
cashmere	cashmere	<b>F1 Knotty raw</b>		<b>F3 Striped brushed</b>	
optiwhite	optiwhite	olive	to choice	beachwood	to choice
snow	snow	pastell loam	to choice	bianco	bianco
<b>ACG - Acrylic glossy</b>					
bianco	bianco	pastell shadow	to choice	black	black
black	black	pastell smoke	to choice	chalk	to choice
fumo	to choice	plage	to choice	chestnut	to choice
cashmere	cashmere	shell	Ⓝ shell	driftwood	to choice
snow	snow	<b>F2 Knotty brushed</b>			
<b>F1 Knotty raw</b>					
beachwood	to choice	beachwood	to choice	olive	to choice
bianco	bianco	bianco	bianco	shell	Ⓝ shell
black	black	black	black	walnut	to choice
chalk	to choice	chalk	to choice	<b>F4 Silky smart</b>	
chestnut	to choice	chestnut	to choice	bianco	bianco
driftwood	to choice	driftwood	to choice	black	black
graphite	graphite	nature	to choice	olive	to choice
nature	to choice	olive	to choice	shell	Ⓝ shell
		real-nature	to choice		
		shell	Ⓝ shell		
		walnut	to choice		

## Visible sides

## LITE LINE

If the carcass is ordered with a visible side, please keep in mind that its edge comes in the colour of the visible side. All other edges are displayed in the ordered carcass colour. Due to the characteristics of a wooden material, the colours of a visible side can deviate slightly from the colour play of the displayed door style.

### VISIBLE SIDES AT NO EXTRA CHARGE

VISIBLE SIDE:	CARCASS:	VISIBLE SIDE:	CARCASS:	VISIBLE SIDE:	CARCASS:
<b>KS melamine</b>					
arcai-red	Ⓝ to choice	<b>KS melamine</b>		<b>UM Melamine ultra-matt</b>	
blackblue	Ⓝ to choice	sharky	to choice	bianco	bianco
blackgreen	Ⓝ to choice	shell	Ⓝ to choice	magnolia	to choice
fango	to choice	snow	to choice	snow	to choice
grigio	to choice	stormgrey	Ⓝ to choice	<b>EG Fine gloss</b>	
cashmere	to choice	<b>WL Woodline</b>			
pebble-grey	to choice	bianco	bianco	bianco	bianco
magnolia	to choice	black burned	Ⓝ to choice	cashmere	to choice
moss	to choice	denver-oak	to choice	optiwhite	to choice
muscata	to choice	oak bardolino	to choice		
optiwhite	to choice	natural knotty oak	to choice		
orion	Ⓝ to choice	sanremo oak	to choice		
		vicenza oak claire	to choice		

### VISIBLE SIDES AT EXTRA CHARGE

VISIBLE SIDE:	CARCASS:	VISIBLE SIDE:	CARCASS:	VISIBLE SIDE:	CARCASS:
<b>ST Texture</b>					
amber	to choice	<b>ST Texture</b>		<b>UVM Matt lacquered</b>	
argento	to choice	sherwood burned wood	to choice	aqua	to choice
basalt dunkel	to choice	sherwood bushy park	to choice	bianco	bianco
black (Albero)	Ⓝ to choice	sherwood cigar	to choice	black	to choice
black (Cemento)	to choice	sherwood engadina	to choice	carbon	carbon
black (Metall)	to choice	sherwood graphite	to choice	crush gold	to choice
brown (Metall)	to choice	sherwood greenwich	to choice	dolphin	delphin
coffee	Ⓝ to choice	sherwood nature	to choice	fango	to choice
halifax crack oak	to choice	dark steel	to choice	cashmere	to choice
halifax nature	to choice	steel blue	to choice	pebble-grey	to choice
halifax tin dark	Ⓝ to choice	light umbra	to choice	laguna	to choice
halifax white	to choice	walnut	Ⓝ to choice	ocean	to choice
knotty oak	to choice	<b>SM HPL matt</b>			
light grey	to choice	bianco	bianco	slate	slate
nature	Ⓝ to choice	magnolia	to choice	snow	to choice
noce	Ⓝ to choice	optiwhite	to choice	steel gold-brown	to choice
light oxide	to choice	shell	Ⓝ to choice	<b>ML - Matt lacquered</b>	
sherwood black	to choice			snow	to choice

## Visible sides

## LITE LINE

If the carcass is ordered with a visible side, please keep in mind that its edge comes in the colour of the visible side. All other edges are displayed in the ordered carcass colour. Due to the characteristics of a wooden material, the colours of a visible side can deviate slightly from the colour play of the displayed door style.

### VISIBLE SIDES AT EXTRA CHARGE

VISIBLE SIDE:	CARCASS:	VISIBLE SIDE:	CARCASS:	VISIBLE SIDE:	CARCASS:
<b>SG HPL gloss</b>		<b>UVHG Lacquer high-gloss</b>		<b>LG High-gloss lacquered</b>	
bianco	bianco	bianco	bianco	bianco	bianco
magnolia	to choice	grigio	to choice	snow	to choice
optiwhite	to choice	cashmere	to choice		
snow	to choice	optiwhite	to choice		
		snow	to choice		

## Visible sides

## NEW LINE

If the carcass is ordered with a visible side, please keep in mind that its edge comes in the colour of the visible side. All other edges are displayed in the ordered carcass colour. Due to the characteristics of a wooden material, the colours of a visible side can deviate slightly from the colour play of the displayed door style.

### VISIBLE SIDES AT NO EXTRA CHARGE

VISIBLE SIDE:	CARCASS:	VISIBLE SIDE:	CARCASS:	VISIBLE SIDE:	CARCASS:
<b>KS melamine</b>		<b>WL Woodline</b>		<b>UM Melamine ultra-matt</b>	
arcai-red	Ⓝ to choice	bianco	bianco	bianco	bianco
blackblue	Ⓝ to choice	black burned	Ⓝ to choice	magnolia	to choice
blackgreen	Ⓝ to choice	denver oak	to choice	snow	to choice
carbon	carbon	oak bardolino	to choice	<b>EG Fine gloss</b>	
dolphin	dolphin	natural knotty oak	to choice	bianco	bianco
fango	to choice	sanremo oak	to choice	cashmere	to choice
grigio	to choice	vicenza oak claire	to choice	optiwhite	to choice
cashmere	to choice				
pebble-grey	to choice				
moss	to choice				
muscata	to choice				
optiwhite	to choice				
orion	Ⓝ to choice				
sharky	to choice				
shell	Ⓝ to choice				
slate	slate				
stormgrey	Ⓝ to choice				

### VISIBLE SIDES AT EXTRA CHARGE

<b>ST Texture</b>		<b>SM HPL matt</b>		<b>UVHG Lacquer high-gloss</b>	
amber	to choice	bianco	bianco	bianco	bianco
argento	to choice	magnolia	to choice	grigio	to choice
basalt dunkel	to choice	optiwhite	to choice	cashmere	to choice
black (Cemento)	to choice	shell	Ⓝ to choice	optiwhite	to choice
halifax crack oak	to choice	<b>SG HPL gloss</b>		snow	to choice
halifax nature	to choice	bianco	bianco		
halifax tin dark	Ⓝ to choice	magnolia	to choice		
halifax white	to choice	optiwhite	to choice		
knotty oak	to choice	snow	to choice		
light grey	to choice				
light oxide	to choice				
steel blue	to choice				
walnut	Ⓝ to choice				

dimensions in mm

## S 126 WALL UNITS

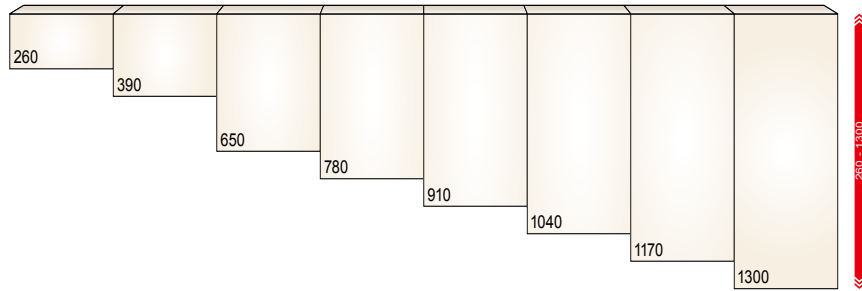

## S 126 BASE UNITS

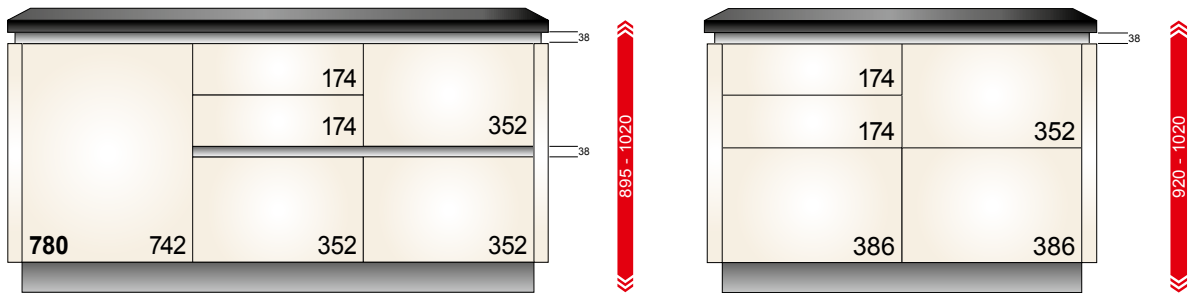

## S 126 TALL UNITS

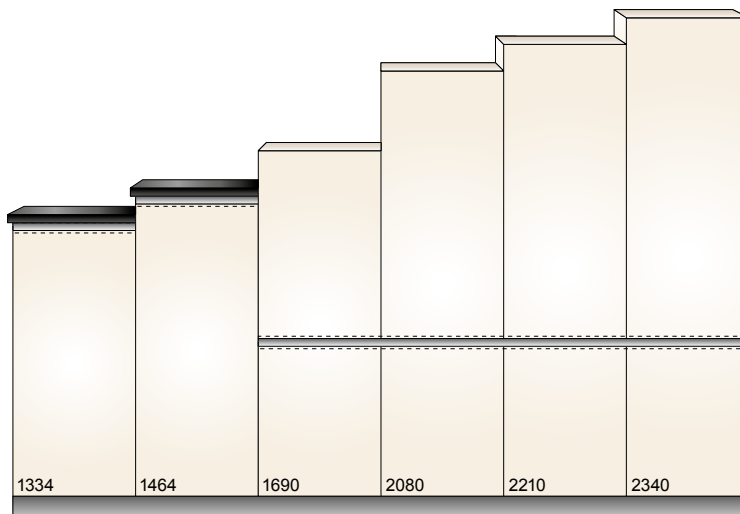

- GL
- GLD E/B
- GLV E/B
- GLX E
- GLV 45
- GLX 90
- GLU

## S 126 COMBINATION OF BASE, TALL AND WALL UNITS

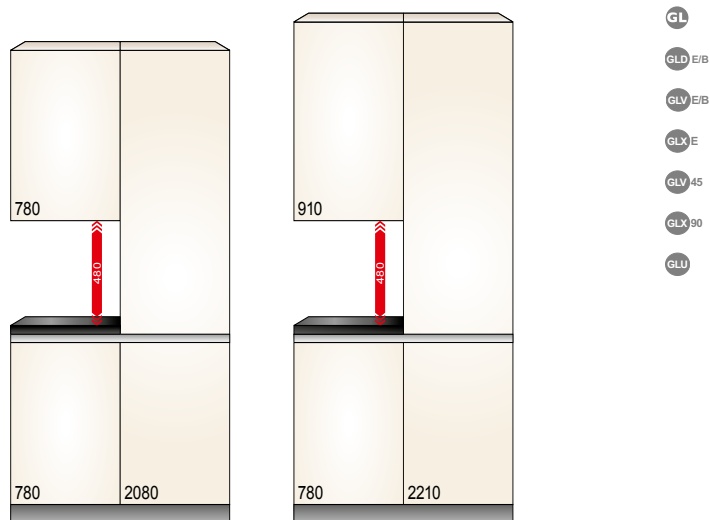



dimensions in mm

WALL UNITS

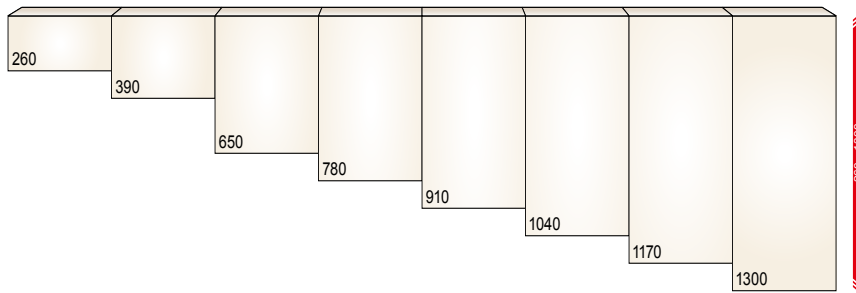

BASE UNITS

		126	126		126	126	126	
			256	386	126	126	126	256
					126	126	256	256
					126			
780	776	646	386	386	126	256	256	256

TALL UNITS

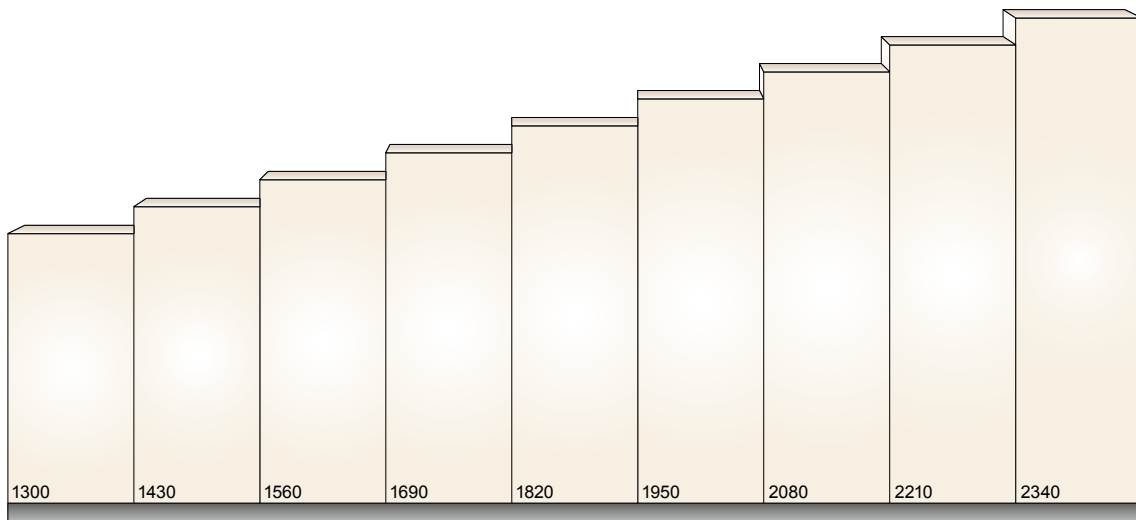

COMBINATION OF BASE, TALL AND WALL UNITS

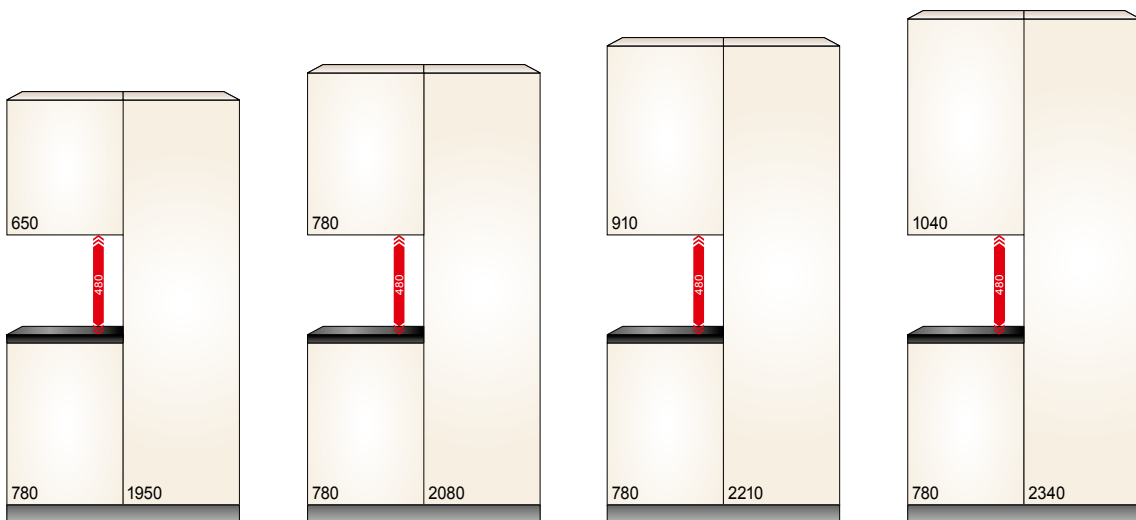

dimensions in mm

WALL UNITS

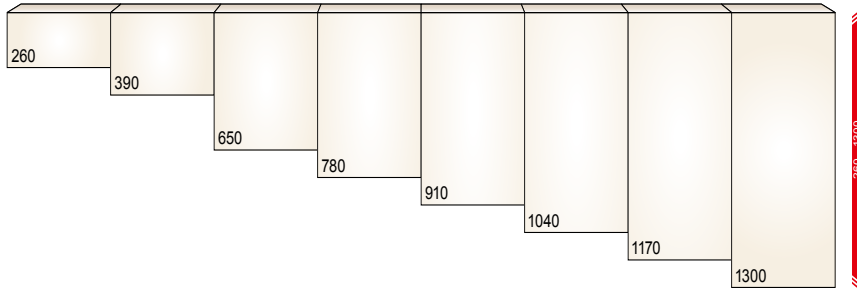

BASE UNITS

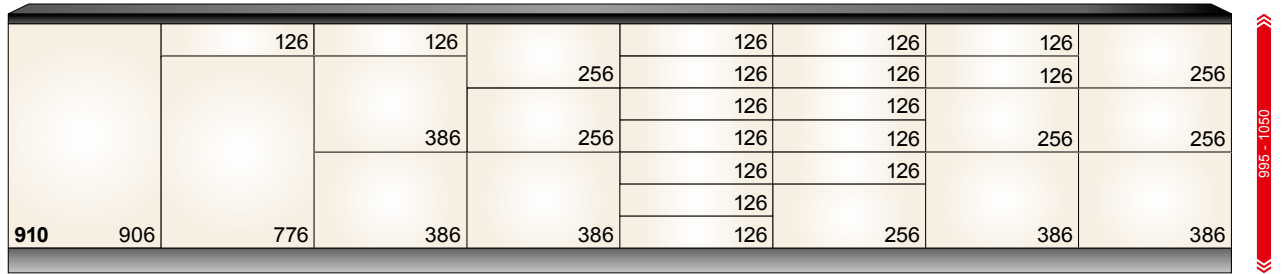

TALL UNITS

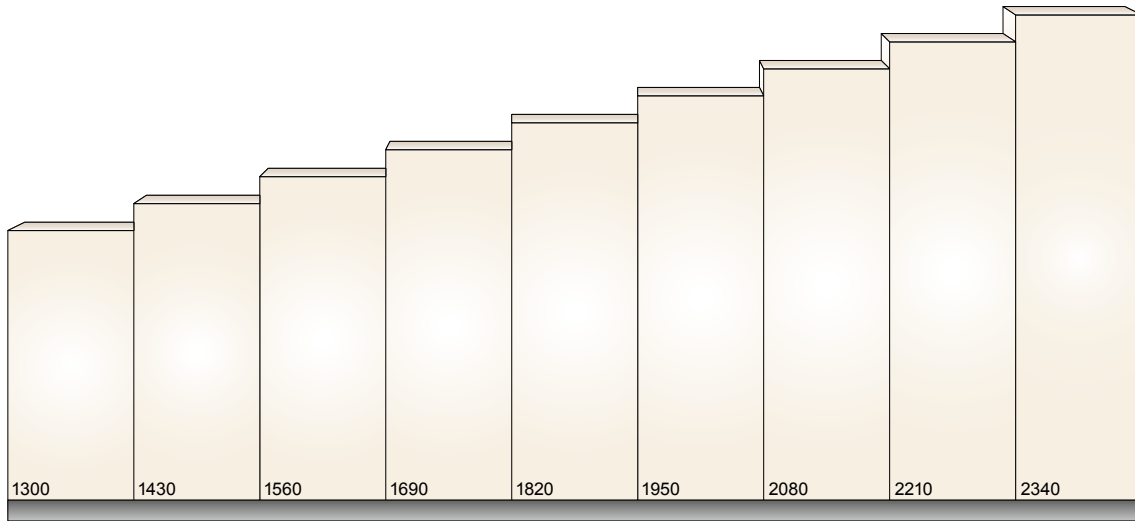

COMBINATION OF BASE, TALL AND WALL UNITS

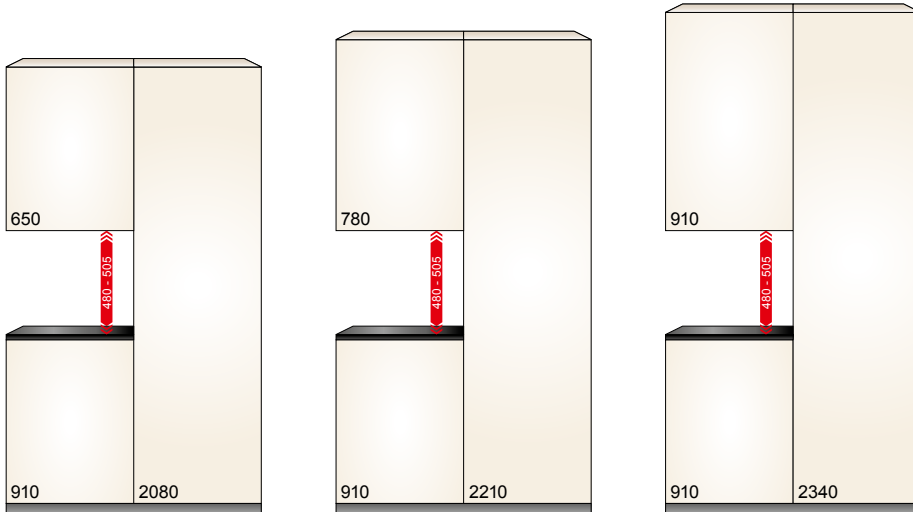

dimensions in mm

S 126 WALL UNITS

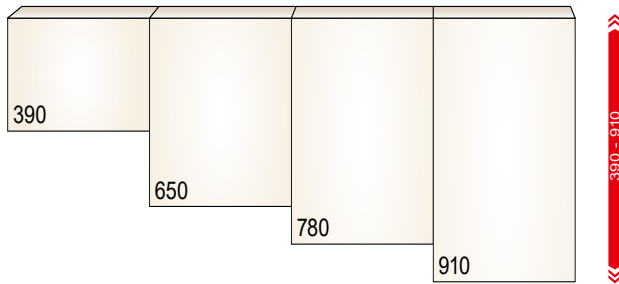

S 126 BASE UNITS

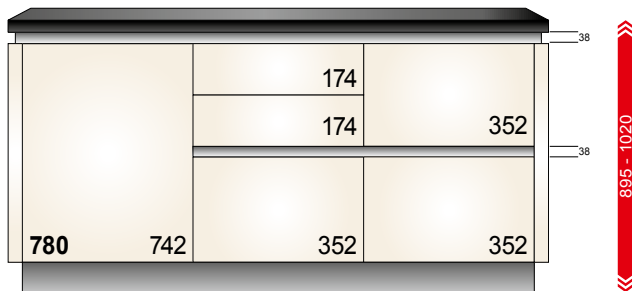

S 126 TALL UNITS

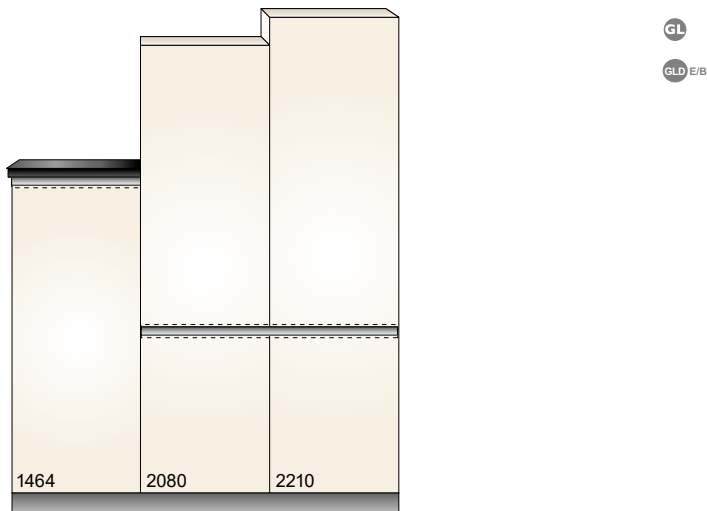

S 126 COMBINATION OF BASE, TALL AND WALL UNITS

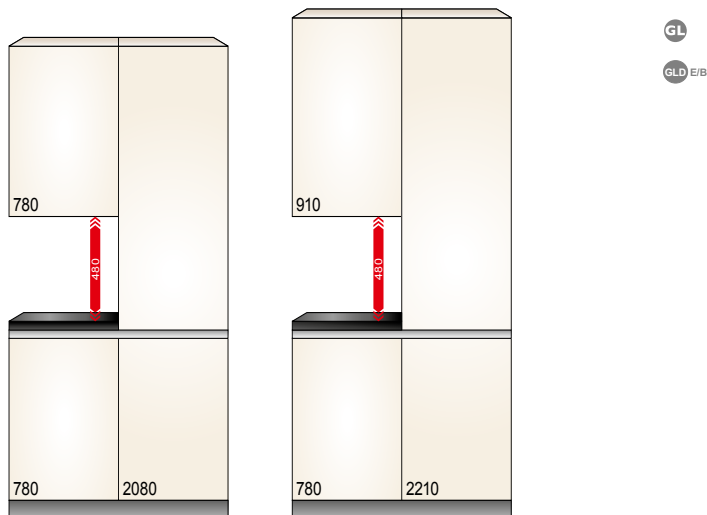

dimensions in mm

WALL UNITS

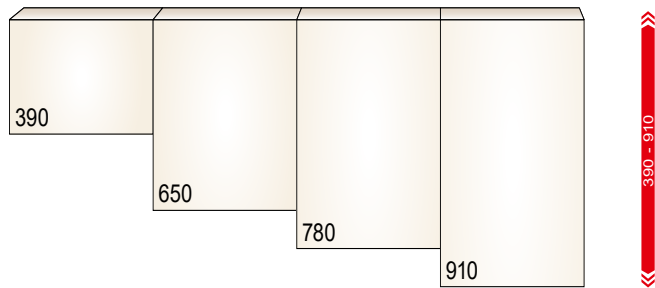

BASE UNITS

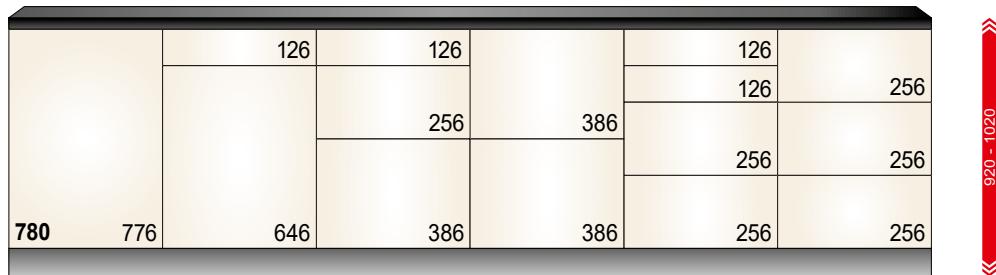

TALL UNITS

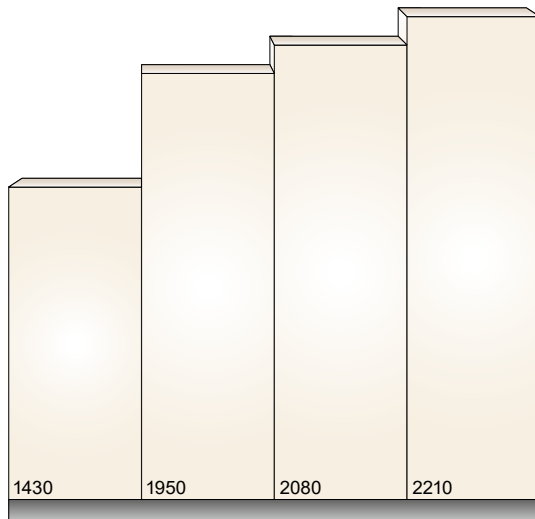

COMBINATION OF BASE, TALL AND WALL UNITS

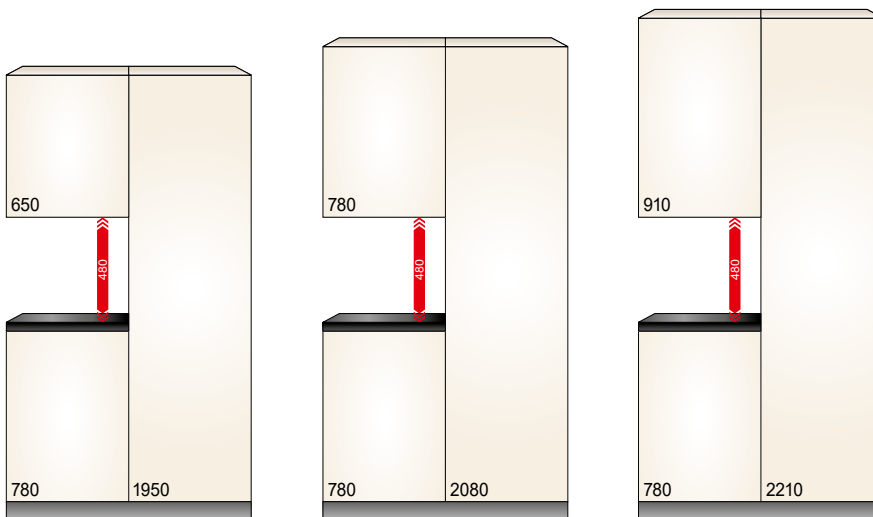

dimensions in mm

S 126 WALL UNITS

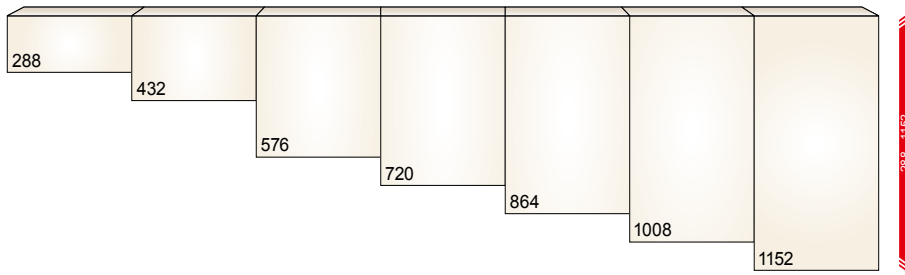

S 126 BASE UNITS

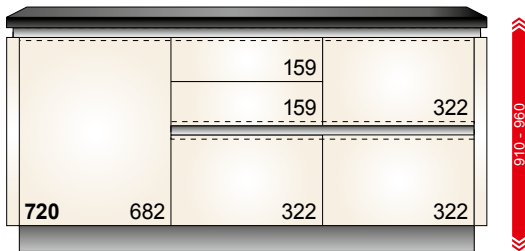

S 126 TALL UNITS

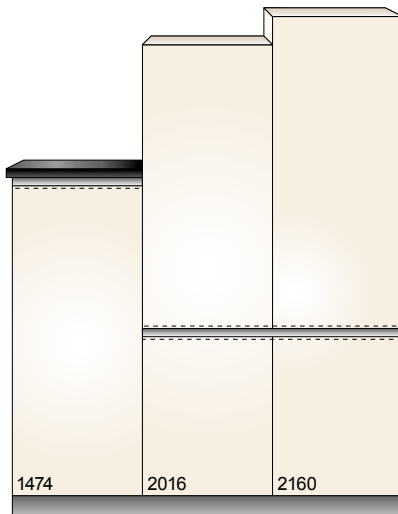

S 126 COMBINATION OF BASE, TALL AND WALL UNITS

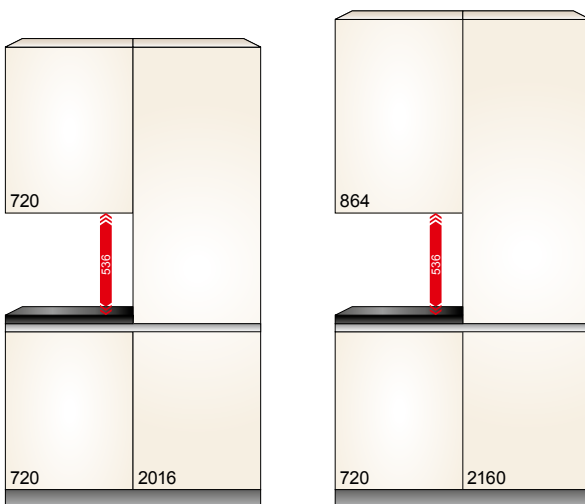

dimensions in mm

WALL UNITS

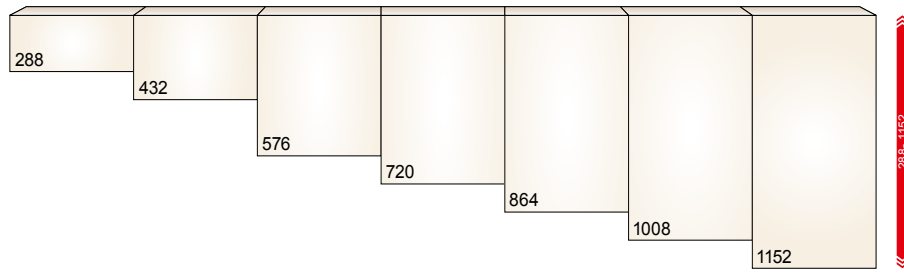

BASE UNITS

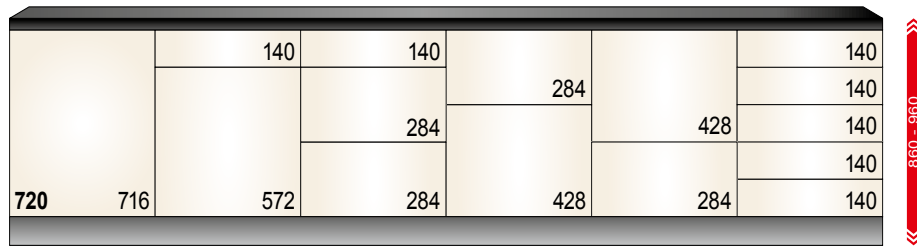

TALL UNITS

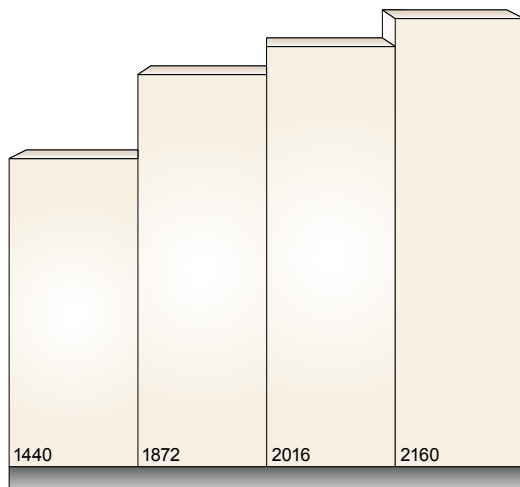

COMBINATION OF BASE, TALL AND WALL UNITS

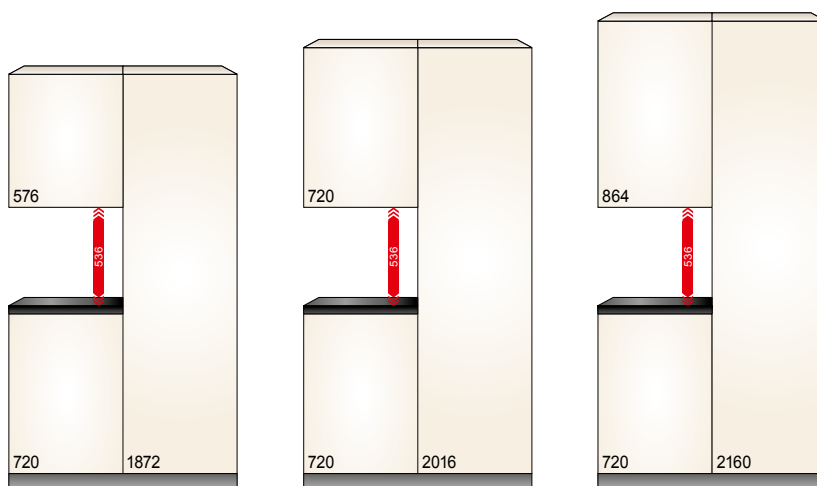

# Universal glass doors

FRAME 20 MM	GLASS STYLE	ALU	INOX	SNOW	BLACK
		A20	I20	S20	B20
	Clear glass (KG)	*	*	*	*
	Matt satinato (SAT M)	*	*	*	*
	Shiny satinato (SAT G)	*	*	*	*
	Shiny black glass (SG G)	-	-	-	*

Aluminium frame **20 x 20** mm in various colour options.  
Frame available with metal knob or handleless.

**Please always specify the required glass style.**

FRAME 50 MM	GLASS STYLE	ALU	INOX	SNOW	BLACK
		A50	I50	S50	B50
	Clear glass (KG)	*	*	*	*
	Matt satinato (SAT M)	*	*	*	*
	Shiny satinato (SAT G)	*	*	*	*
	Shiny black glass (SG G)	-	-	-	*

Polished aluminium frame **50 x 20** mm in various colour options.  
Frame available with handleless or bar handle STG/STGE/STGEB (extra charge applicable).





**Please always specify the required glass type.**

FRAME 55 MM	GLASS STYLE	INDUSTRY LOOK
		IL55
	Clear glass (KG)	*

Frame **55 x 20** mm in the industry look.  
The frame is always supplied without drilling.  
Tip-On required (at extra charge).

FRAME 20 MM	GLASS STYLE	CROSSBAR DOOR
		SP20
	Clear glass (KG)	*

Frame **20 x 20** mm with crossbars, black lacquered aluminium.  
The frame can only be supplied with metal knob or handleless.

GLASS STYLE			
			
KG	SAT M	SAT G	SG G



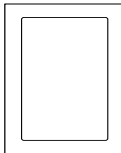
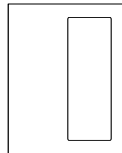
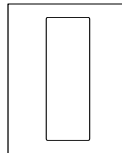
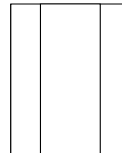
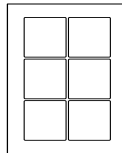
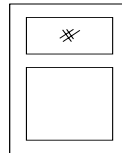

**KG** Clear glass  
**SAT M** Matt satinato  
**SAT G** Shiny satinato  
**SG G** Shiny black glass

# Range-assigned glass doors

R	G*/GA*	GM	L	K	H
					
KG	KG	KG	KG	KG	KG
SAT M	SAT M	SAT M	SAT M	SAT M	SAT M
SAT G	SAT G	SAT G	SAT G	SAT G	SAT G
SG G	SG G	SG G	SG G	SG G	SG G

**G\*** Glass element can be positioned either left or right.  
Glass cut-out opposite the hinged side.

**GA\*** Glass element can be positioned either left or right.  
Glass cut-out opposite the hinged side.

GLASS STYLE			
			
KG	SAT M	SAT G	SG G

**KG** Clear glass  
**SAT M** Matt satinato,  
**SAT G** Shiny satinato  
**SG G** Shiny black glass



- Elegant slim box system in the colour matt orion grey
- The drawer frames are absolutely straight inside and out, featuring 12.8 mm thick sides
- Metal back panel
- Undermounted runners
- High dynamic load-bearing capacity  
40 kg up to 60 cm width  
70 kg from a width of 80 cm upwards
- Smooth running action even when fully loaded
- Silent and effortless closing with integrated BLUMOTION
- Minimal sag due to the sturdy cabinet profile
- Colour-matched inner dividing system
- TIP-ON BLUMOTION available for LEGRABOX (mechanical one-touch opening for drawers and pull-outs)
- SERVO-DRIVE flex available for the electrical opening of handleless integrated fridges and dishwashers



**Legrabox - Free**  
with 10 mm clear glass  
(extra charge)



Screw-fastened 5 mm **MDF** back panel  
19 mm solid wood crossmember in front

Standard carcass depth 575 mm,  
550 mm optional at no extra charge

**18** different carcass colours,  
matching colour inside and out

Thin-walled LEGRABOX with under-  
mounted runners and steel back panel

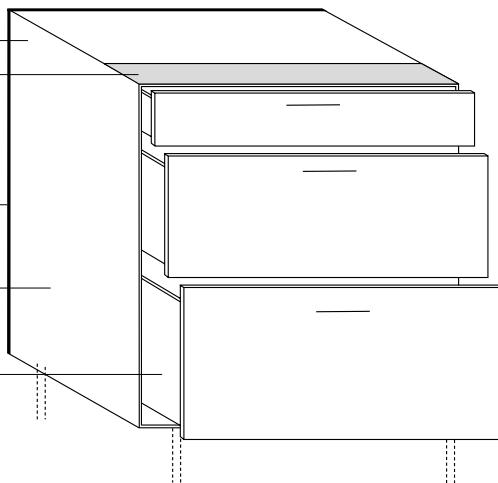

**19 mm carcass**

Concealed hanging brackets

Screw-fastened 5 mm **MDF** back panel

19 mm removable shelves with  
securing pin

**(N)** 3 mm shelf supports dark color

**(N)** Blum all-metal hinges onyx-black  
with integral damping 180° hinge with  
integral damping

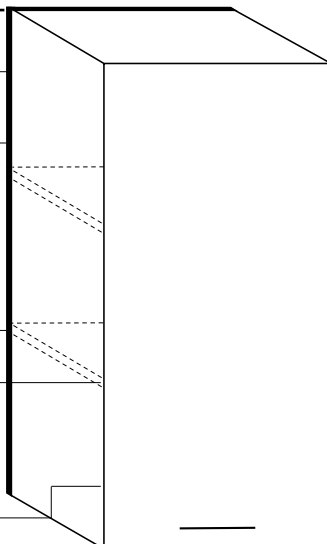

**E**Large

**X**Tend

**(←E**Wide**→)**

**DARK PERFECTION**



Larder units with full-height pull-out interior /LeMans units:  
as standard with anthracite coloured powder-coated interior  
fittings







**INTERIOR**

**S 126 | GL780**

- proven drawer system on the Tandembox plus cabinet rail in Orion grey matt.
- Tandembox Antaro is characterised by its clear-cut design (rectangular rail)
- steel back wall
- easy glide running
- high dynamic carrying capacity:  
Up to 60 cm width 30 kg  
from 80 cm width pull-outs can be loaded with 50 kg
- high front stability
- matching inner dividing system
- Tip-on blumotion for Tandembox ANTARO available (mechanical Tip-on system für drawers/pull-outs)

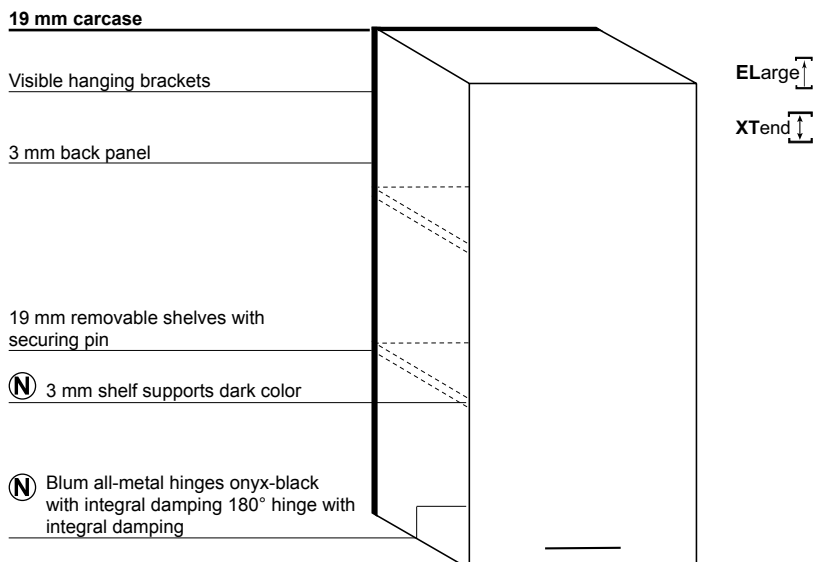
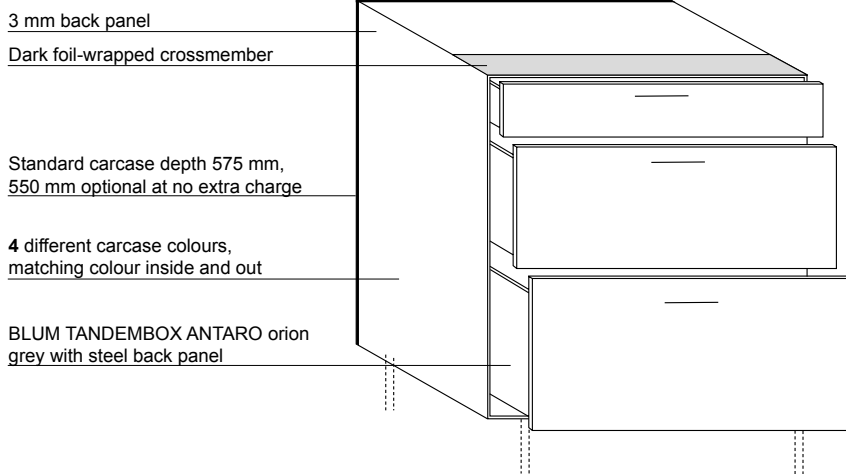



- proven drawer system on the Tandembox plus cabinet rail in Orion grey.
- round rail for pull-outs
- steel back wall
- easy glide running
- high dynamic carrying capacity:  
Up to 60 cm width 30 kg  
from 80 cm width pull-outs can be loaded with 50 kg
- high front stability
- matching inner dividing system
- Tip-on blumotion for Tandembox-Plus available  
(mechanical Tip-on system for drawers/pull-outs)

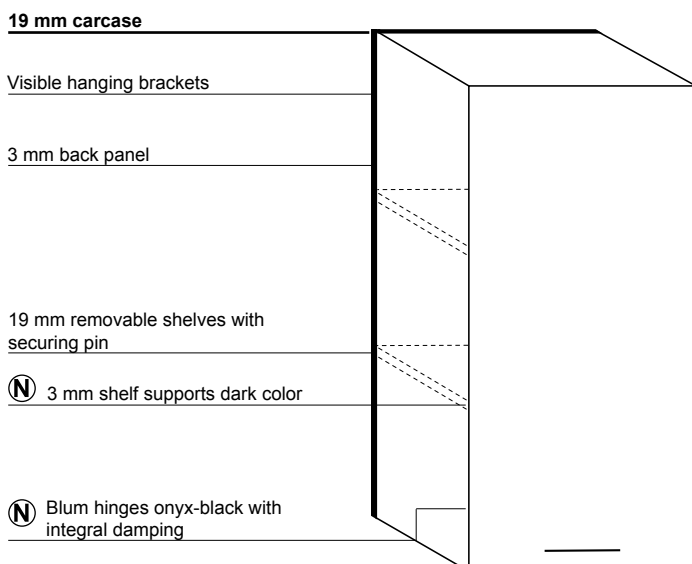
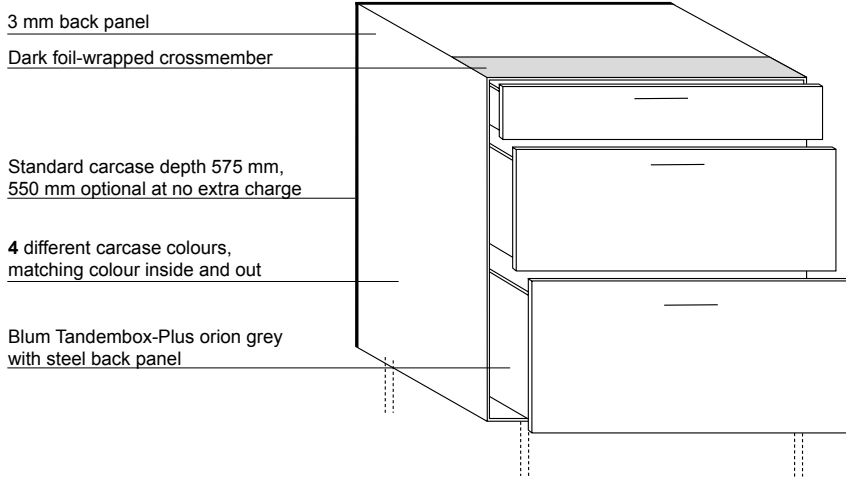

XTend



Melamine  
fronts



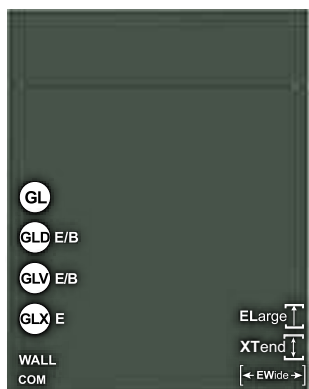

PREMIUM

**Glass doors**  
G/GA/GM/R Framed glass door,  
L Door with vertical side stiles

	TOUCH	COM	Front colour	Carcase	Vis. side	W 19	W50+100	XW5/ XW6	Plinth	Shelving
	<b>P108 260</b>	<b>P229 260</b>	arcai-red	*	KS	KS	KS W100	KS	KS	-
GLV/45	<b>P108 006</b>	<b>P229 006</b>	bianco	KS	UM	UM	UM W100	UM	UM	UM
	<b>P108 261</b>	<b>P229 261</b>	blackblue	*	KS	KS	KS W100	KS	KS	-
	<b>P108 262</b>	<b>P229 262</b>	blackgreen	*	KS	KS	KS W100	KS	KS	-
GLV/45	<b>P108 063</b>	<b>P229 063</b>	carbon	KS	-	KS	KS	KS	KS	KS
GLV/45	<b>P108 123</b>	<b>P229 123</b>	dolphin	KS	-	KS	KS	KS	KS	KS
GLV/45	<b>P108 014</b>	<b>P229 014</b>	fango	*	KS	KS	KS	KS	KS	KS
GLV/45	<b>P108 095</b>	<b>P229 095</b>	grigio	KS	-	KS	KS	KS	KS	KS
GLV/45	<b>P108 024</b>	<b>P229 024</b>	cashmere	KS	-	KS	KS	KS	KS	KS
GLV/45	<b>P108 064</b>	<b>P229 064</b>	pebble-grey	KS	-	KS	KS	KS	KS	KS
GLV/45	<b>P108 090</b>	<b>P229 090</b>	magnolia	KS	UM	UM	UM W100	UM	UM	UM
	<b>P108 112</b>	<b>P229 112</b>	moss	*	KS	KS	KS W100	KS	KS	-
	<b>P108 013</b>	<b>P229 013</b>	muscata	*	KS	KS	KS	KS	KS	KS
	<b>P108 007</b>	<b>P229 007</b>	optiwhite	KS	-	KS	KS	KS	KS	KS
	<b>P108 243</b>	<b>P229 243</b>	orion	KS	-	KS	KS	KS	KS	KS
GLV/45	<b>P108 126</b>	<b>P229 126</b>	sharky	KS	-	KS	KS	KS	KS	KS
	<b>P108 244</b>	<b>P229 244</b>	shell	KS	-	KS	KS	KS	KS	KS
GLV/45	<b>P108 128</b>	<b>P229 128</b>	slate	KS	-	KS	KS	KS	KS	KS
GLV/45	<b>P108 101</b>	<b>P229 101</b>	snow	KS	UM	UM	UM W100	UM	UM	UM
	<b>P108 263</b>	<b>P229 263</b>	stormgrey	*	KS	KS	KS W100	KS	KS	-



LITE

**Glass doors**  
Only universal glass doors available

	TOUCH	Front colour	Carcase	Vis. side	W 19	W50+100	XW5/ XW6	Plinth	Shelving
	<b>L108 260</b>	arcai-red	*	KS	KS	KS W100	KS	KS	-
	<b>L108 006</b>	bianco	KS	UM	UM	UM W100	UM	UM	UM
	<b>L108 261</b>	blackblue	*	KS	KS	KS W100	KS	KS	-
	<b>L108 262</b>	blackgreen	*	KS	KS	KS W100	KS	KS	-
	<b>L108 063</b>	carbon	KS	-	KS	KS	KS	KS	KS
	<b>L108 123</b>	dolphin	KS	-	KS	KS	KS	KS	KS
	<b>L108 014</b>	fango	*	KS	KS	KS	KS	KS	KS
	<b>L108 095</b>	grigio	*	KS	KS	KS	KS	KS	KS
	<b>L108 024</b>	cashmere	*	KS	KS	KS	KS	KS	KS
	<b>L108 064</b>	pebble-grey	*	KS	KS	KS	KS	KS	KS
	<b>L108 090</b>	magnolia	*	UM	UM	UM W100	UM	UM	UM
	<b>L108 112</b>	moss	*	KS	KS	KS W100	KS	KS	-
	<b>L108 013</b>	muscata	*	KS	KS	KS	KS	KS	KS
	<b>L108 007</b>	optiwhite	*	KS	KS	KS	KS	KS	KS
	<b>L108 243</b>	orion	*	KS	KS	KS	KS	KS	KS
	<b>L108 126</b>	sharky	*	KS	KS	KS	KS	KS	KS
	<b>L108 244</b>	shell	*	KS	KS	KS	KS	KS	KS
	<b>L108 128</b>	slate	KS	-	KS	KS	KS	KS	KS
	<b>L108 101</b>	snow	*	UM	UM	UM W100	UM	UM	UM
	<b>L108 263</b>	stormgrey	*	KS	KS	KS W100	KS	KS	-



**NEW**

**Glass doors**  
R Framed glass door,  
L Door with vertical side stiles

TOUCH	Front colour	Carcase	Vis. side	W 19	W50+100	XW5/ XW6	Plinth	Shelving
N108 260	arcai-red	*	KS	KS	-	KS	KS	-
N108 006	bianco	KS	UM	UM	-	UM	UM	UM
N108 261	blackblue	*	KS	KS	-	KS	KS	-
N108 262	blackgreen	*	KS	KS	-	KS	KS	-
N108 063	carbon	KS	-	KS	-	KS	KS	KS
N108 123	dolphin	KS	-	KS	-	KS	KS	KS
N108 014	fango	*	KS	KS	-	KS	KS	KS
N108 095	grigio	*	KS	KS	-	KS	KS	KS
N108 024	cashmere	*	KS	KS	-	KS	KS	KS
N108 064	pebble-grey	*	KS	KS	-	KS	KS	KS
N108 090	magnolia	*	UM	UM	-	UM	UM	UM
N108 112	moss	*	KS	KS	-	KS	KS	-
N108 013	muscata	*	KS	KS	-	KS	KS	KS
N108 007	optiwhite	*	KS	KS	-	KS	KS	KS
N108 243	orion	*	KS	KS	-	KS	KS	KS
N108 126	sharky	*	KS	KS	-	KS	KS	KS
N108 244	shell	*	KS	KS	-	KS	KS	KS
N108 128	slate	KS	-	KS	-	KS	KS	KS
N108 101	snow	*	UM	UM	-	UM	UM	UM
N108 263	stormgrey	*	KS	KS	-	KS	KS	-



Front: Melamine with fine-matt (KS)/ ultra-matt (UM) surface and zero joint edge all around, reverse side in the same colour (the surface feel of the different colours varies slightly)

Handle drilling options

TOUCH

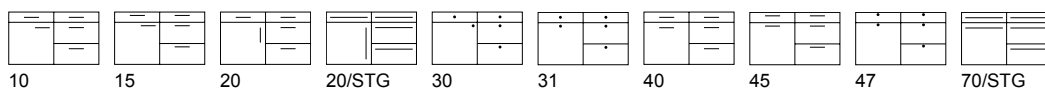

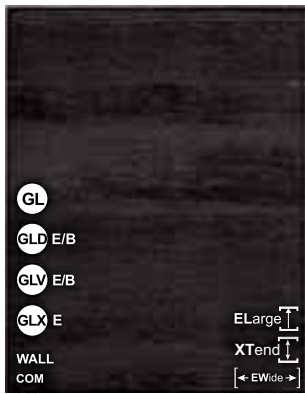

**PREMIUM**

PORTO H	COM	Front colour	Carcase	Vis. side	W 19	W50+100	XW5/ XW6	Plinth	Shelving
<b>P105 006</b>	<b>P250 006</b>	bianco, <b>H</b>	KS	WL	WL	WL	WL	WL	WL
<b>P105 267</b>	<b>P250 267</b>	black burned, <b>H</b>	*	WL	WL	WL W100	WL	WL	-
<b>P105 023</b>	<b>P250 023</b>	denver-oak, <b>H</b>	*	WL	WL	WL W100	WL	WL	-
<b>P105 045</b>	<b>P250 045</b>	oak bardolino, <b>H</b>	*	WL	WL	WL	WL	WL	WL
<b>P105 028</b>	<b>P250 028</b>	nat. knotty oak, <b>H</b>	KS	-	WL	WL	WL	WL	WL

PORTO V	COM	Front colour	Carcase	Vis. side	W 19	W50+100	XW5/ XW6	Plinth	Shelving
<b>P104 006</b>	<b>P249 006</b>	bianco, <b>V</b>	KS	WL	WL	WL	WL	WL	WL
<b>P104 267</b>	<b>P249 267</b>	black burned, <b>V</b>	*	WL	WL	WL W100	WL	WL	-
<b>P104 023</b>	<b>P249 023</b>	denver-oak, <b>V</b>	*	WL	WL	WL W100	WL	WL	-
<b>P104 045</b>	<b>P249 045</b>	oak bardolino, <b>V</b>	*	WL	WL	WL	WL	WL	WL
<b>P104 028</b>	<b>P249 028</b>	nat. knotty oak, <b>V</b>	KS	-	WL	WL	WL	WL	WL

**Glass doors**  
G/GA/GM/R Framed glass door,  
L Door with vertical side stiles



**LITE**

PORTO H	Front colour	Carcase	Vis. side	W 19	W50+100	XW5/ XW6	Plinth	Shelving
<b>L105 006</b>	bianco, <b>H</b>	KS	WL	WL	WL	WL	WL	WL
<b>L105 267</b>	black burned, <b>H</b>	*	WL	WL	WL W100	WL	WL	-
<b>L105 023</b>	denver-oak, <b>H</b>	*	WL	WL	WL W100	WL	WL	-
<b>L105 045</b>	oak bardolino, <b>H</b>	*	WL	WL	WL	WL	WL	WL
<b>L105 028</b>	nat. knotty oak, <b>H</b>	*	WL	WL	WL	WL	WL	WL

PORTO V	Front colour	Carcase	Vis. side	W 19	W50+100	XW5/ XW6	Plinth	Shelving
<b>L104 006</b>	bianco, <b>V</b>	KS	WL	WL	WL	WL	WL	WL
<b>L104 267</b>	black burned, <b>V</b>	*	WL	WL	WL W100	WL	WL	-
<b>L104 023</b>	denver-oak, <b>V</b>	*	WL	WL	WL W100	WL	WL	-
<b>L104 045</b>	oak bardolino, <b>V</b>	*	WL	WL	WL	WL	WL	WL
<b>L104 028</b>	nat. knotty oak, <b>V</b>	*	WL	WL	WL	WL	WL	WL

**Glass doors**  
Only universal glass doors available



**NEW**

PORTO H	Front colour	Carcase	Vis. side	W 19	W50+100	XW5/ XW6	Plinth	Shelving
<b>N105 006</b>	bianco, <b>H</b>	KS	WL	WL	-	WL	WL	WL
<b>N105 267</b>	black burned, <b>H</b>	*	WL	WL	-	WL	WL	-
<b>N105 023</b>	denver-oak, <b>H</b>	*	WL	WL	-	WL	WL	-
<b>N105 045</b>	oak bardolino, <b>H</b>	*	WL	WL	-	WL	WL	WL
<b>N105 028</b>	nat. knotty oak, <b>H</b>	*	WL	WL	-	WL	WL	WL

PORTO V	Front colour	Carcase	Vis. side	W 19	W50+100	XW5/ XW6	Plinth	Shelving
<b>N104 006</b>	bianco, <b>V</b>	KS	WL	WL	-	WL	WL	WL
<b>N104 267</b>	black burned, <b>V</b>	*	WL	WL	-	WL	WL	-
<b>N104 023</b>	denver-oak, <b>V</b>	*	WL	WL	-	WL	WL	-
<b>N104 045</b>	oak bardolino, <b>V</b>	*	WL	WL	-	WL	WL	WL
<b>N104 028</b>	nat. knotty oak, <b>V</b>	*	WL	WL	-	WL	WL	WL

**Glass doors**  
R Framed glass door,  
L Door with vertical side stiles



bianco, **H**    black burned, **H**    denver-oak, **H**    oak bardolino, **H**    nat. knotty oak, **H**



bianco, **V**    black burned, **V**    denver-oak, **V**    oak bardolino, **V**    nat. knotty oak, **V**

Front: Melamine, 0.8 mm edge all around, wood decor with **horizontally/vertically running** woodline surface or similar structure, reverse side in the same colour

Handle drilling options    PORTO H+V woodline

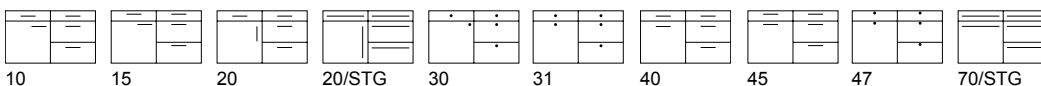

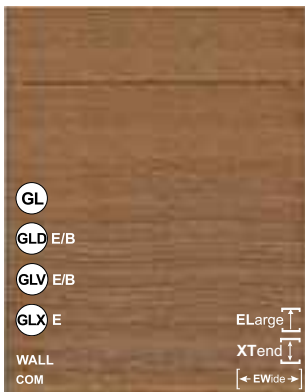

**Glass doors**

G/GA/GM/R Framed glass door,  
L Door with vertical side stiles

ALBERO H	COM	Front colour	Carcase	Vis. side	W 19	W 100	XW5/ XW6	Plinth	Shelving
P116 252	P211 252	black, H	KS	ST	ST	ST	ST	ST	ST
P116 253	P211 253	coffee, H	*	ST	ST	ST	ST	ST	ST
P116 255	P211 255	nature, H	*	ST	ST	ST	ST	ST	ST
P116 254	P211 254	noce, H	*	ST	ST	ST	ST	ST	ST

ALBERO V	COM	Front colour	Carcase	Vis. side	W 19	W 100	XW5/ XW6	Plinth	Shelving
P117 252	P212 252	black, V	KS	ST	ST	ST	ST	ST	ST
P117 253	P212 253	coffee, V	*	ST	ST	ST	ST	ST	ST
P117 255	P212 255	nature, V	*	ST	ST	ST	ST	ST	ST
P117 254	P212 254	noce, V	*	ST	ST	ST	ST	ST	ST

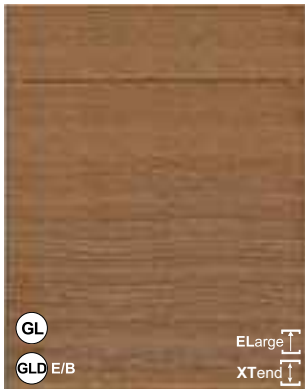

**Glass doors**

Only universal glass doors available

ALBERO H	Front colour	Carcase	Vis. side	W 19	W 100	XW5/ XW6	Plinth	Shelving
L116 252	black, H	*	ST	ST	ST	ST	ST	ST
L116 253	coffee, H	*	ST	ST	ST	ST	ST	ST
L116 255	nature, H	*	ST	ST	ST	ST	ST	ST
L116 254	noce, H	*	ST	ST	ST	ST	ST	ST

ALBERO V	Front colour	Carcase	Vis. side	W 19	W 100	XW5/ XW6	Plinth	Shelving
L117 252	black, V	*	ST	ST	ST	ST	ST	ST
L117 253	coffee, V	*	ST	ST	ST	ST	ST	ST
L117 255	nature, V	*	ST	ST	ST	ST	ST	ST
L117 254	noce, V	*	ST	ST	ST	ST	ST	ST

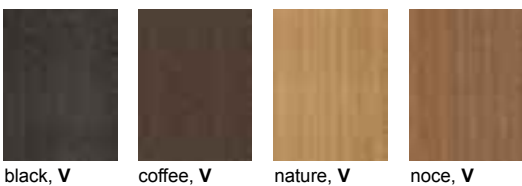

Front: Thick-film melamine with deep synchronized pore finish and **horizontally/vertically running** grain, with same matching decor edge all around, reverse side in the same colour

Handle drilling options

ALBERO H+V

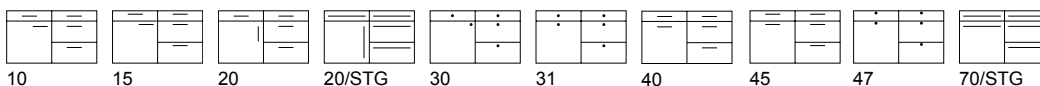



**P  
R  
E  
M  
I  
U  
M**

### Glass doors

G/GA/GM/R Framed glass door,  
L Door with vertical side stiles

SINCRONO H	COM	Front colour	Carcase	Vis. side	W 19	W50+100	XW5/ XW6	Plinth	Shelving
GLV <sup>45</sup> P114 200	P206 200	argento, H	*	ST	ST	ST	ST	ST	ST
GLV <sup>45</sup> P114 199	P206 199	halifax crack oak, H	KS	-	ST	ST	ST	ST	ST
GLV <sup>45</sup> P114 175	P206 175	halifax nature, H	*	ST	ST	ST	ST	ST	ST
GLV <sup>45</sup> P114 266	P206 266	halifax tin dark, H	*	ST	ST	ST W100	ST	ST	ST
GLV <sup>45</sup> P114 145	P206 145	halifax white, H	*	ST	ST	ST	ST	ST	ST
GLV <sup>45</sup> P114 115	P206 115	knotty oak, H	*	ST	ST	ST	ST	ST	ST
GLV <sup>45</sup> P114 046	P206 046	sanremo oak, H	*	WL	WL	WL	WL	WL	WL

SINCRONO V	COM	Front colour	Carcase	Vis. side	W 19	W50+100	XW5/ XW6	Plinth	Shelving
GLV <sup>45</sup> P115 200	P207 200	argento, V	*	ST	ST	ST	ST	ST	ST
GLV <sup>45</sup> P115 199	P207 199	halifax crack oak, V	KS	-	ST	ST	ST	ST	ST
GLV <sup>45</sup> P115 175	P207 175	halifax nature, V	*	ST	ST	ST	ST	ST	ST
GLV <sup>45</sup> P115 266	P207 266	halifax tin dark, V	*	ST	ST	ST W100	ST	ST	ST
GLV <sup>45</sup> P115 145	P207 145	halifax white, V	*	ST	ST	ST	ST	ST	ST
GLV <sup>45</sup> P115 115	P207 115	knotty oak, V	*	ST	ST	ST	ST	ST	ST
GLV <sup>45</sup> P115 046	P207 046	sanremo oak, V	*	WL	WL	WL	WL	WL	WL



**L  
I  
T  
E**

### Glass doors

Only universal glass doors available

SINCRONO H	Front colour	Carcase	Vis. side	W 19	W50+100	XW5/ XW6	Plinth	Shelving
L114 200	argento, H	*	ST	ST	ST	ST	ST	ST
L114 199	halifax crack oak, H	*	ST	ST	ST	ST	ST	ST
L114 175	halifax nature, H	*	ST	ST	ST	ST	ST	ST
L114 266	halifax tin dark, H	*	ST	ST	ST W100	ST	ST	ST
L114 145	halifax white, H	*	ST	ST	ST	ST	ST	ST
L114 115	knotty oak, H	*	ST	ST	ST	ST	ST	ST
L114 046	sanremo oak, H	*	WL	WL	WL	WL	WL	WL

SINCRONO V	Front colour	Carcase	Vis. side	W 19	W50+100	XW5/ XW6	Plinth	Shelving
L115 200	argento, H	*	ST	ST	ST	ST	ST	ST
L115 199	halifax crack oak, V	*	ST	ST	ST	ST	ST	ST
L115 175	halifax nature, V	*	ST	ST	ST	ST	ST	ST
L115 266	halifax tin dark, V	*	ST	ST	ST W100	ST	ST	ST
L115 145	halifax white, V	*	ST	ST	ST	ST	ST	ST
L115 115	knotty oak, V	*	ST	ST	ST	ST	ST	ST
L115 046	sanremo oak, V	*	WL	WL	WL	WL	WL	WL





**NEW**

**Glass doors**

R Framed glass door, L Door with vertical side stiles

SINCRONO H	Front colour	Carcase	Vis. side	W 19	W50+100	XW5/ XW6	Plinth	Shelving
<b>N114 200</b>	argento, <b>H</b>	*	ST	ST	-	ST	ST	ST
<b>N114 199</b>	halifax crack oak, <b>H</b>	*	ST	ST	-	ST	ST	ST
<b>N114 175</b>	halifax nature, <b>H</b>	*	ST	ST	-	ST	ST	ST
<b>N114 266</b>	halifax tin dark, <b>H</b>	*	ST	ST	-	ST	ST	ST
<b>N114 145</b>	halifax white, <b>H</b>	*	ST	ST	-	ST	ST	ST
<b>N114 115</b>	knotty oak, <b>H</b>	*	ST	ST	-	ST	ST	ST
<b>N114 046</b>	sanremo oak, <b>H</b>	*	WL	WL	-	WL	WL	WL

SINCRONO V	Front colour	Carcase	Vis. side	W 19	W50+100	XW5/ XW6	Plinth	Shelving
<b>N115 200</b>	argento, <b>V</b>	*	ST	ST	-	ST	ST	ST
<b>N115 199</b>	halifax crack oak, <b>V</b>	*	ST	ST	-	ST	ST	ST
<b>N115 175</b>	halifax nature, <b>V</b>	*	ST	ST	-	ST	ST	ST
<b>N115 266</b>	halifax tin dark, <b>V</b>	*	ST	ST	-	ST	ST	ST
<b>N115 145</b>	halifax white, <b>V</b>	*	ST	ST	-	ST	ST	ST
<b>N115 115</b>	knotty oak, <b>V</b>	*	ST	ST	-	ST	ST	ST
<b>N115 046</b>	sanremo oak, <b>V</b>	*	WL	WL	-	WL	WL	WL



Front: Melamine with synchronized pore finish and **horizontally/vertically running** grain, matching edge, reverse side in the same colour

Handle drilling options

SINCRONO H+V

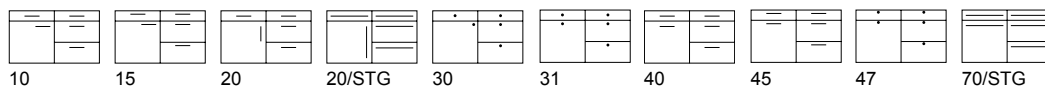

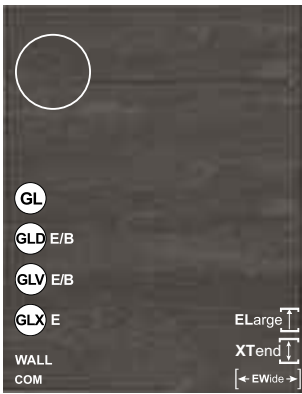

PREMIUM

**Glass doors**  
G/GA/GM/R Framed glass door,  
L Door with vertical side stiles

	SHERWOOD H	COM	Front colour	Carcase	Vis. side	W 19	W 100	XW5/ XW6	Plinth	Shelving
GLV)45	P140 122	P290 122	black, H	KS	ST	ST	ST	ST	ST	ST
	P140 198	P290 198	burned wood, H	*	ST	ST	ST	ST	ST	-
GLV)45	P140 142	P290 142	bushy park, H	*	ST	ST	ST	ST	ST	ST
GLV)45	P140 092	P290 092	cigar, H	*	ST	ST	ST	ST	ST	ST
GLV)45	P140 093	P290 093	engadina, H	*	ST	ST	ST	ST	ST	ST
	P140 203	P290 203	graphite, H	KS	ST	ST	ST	ST	ST	ST
GLV)45	P140 144	P290 144	greenwich, H	*	ST	ST	ST	ST	ST	ST
GLV)45	P140 195	P290 195	nature, H	*	ST	ST	ST	ST	ST	ST

	SHERWOOD V	COM	Front colour	Carcase	Vis. side	W 19	W 100	XW5/ XW6	Plinth	Shelving
GLV)45	P141 122	P291 122	black, V	KS	ST	ST	ST	ST	ST	ST
	P141 198	P291 198	burned wood, V	*	ST	ST	ST	ST	ST	-
GLV)45	P141 142	P291 142	bushy park, V	*	ST	ST	ST	ST	ST	ST
GLV)45	P141 092	P291 092	cigar, V	*	ST	ST	ST	ST	ST	ST
GLV)45	P141 093	P291 093	engadina, V	*	ST	ST	ST	ST	ST	ST
	P141 203	P291 203	graphite, V	KS	ST	ST	ST	ST	ST	ST
GLV)45	P141 144	P291 144	greenwich, V	*	ST	ST	ST	ST	ST	ST
GLV)45	P141 195	P291 195	nature, V	*	ST	ST	ST	ST	ST	ST

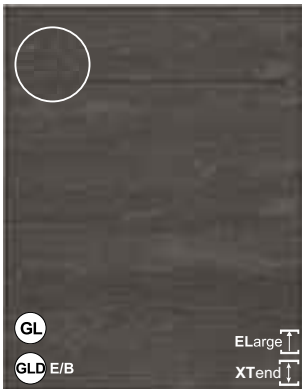

LITE

**Glass doors**  
Only universal glass doors available

	SHERWOOD H	Front colour	Carcase	Vis. side	W 19	W 100	XW5/ XW6	Plinth	Shelving
	L140 122	black, H	*	ST	ST	ST	ST	ST	ST
	L140 198	burned wood, H	*	ST	ST	ST	ST	ST	-
	L140 142	bushy park, H	*	ST	ST	ST	ST	ST	ST
	L140 092	cigar, H	*	ST	ST	ST	ST	ST	ST
	L140 093	engadina, H	*	ST	ST	ST	ST	ST	ST
	L140 203	graphite, H	*	ST	ST	ST	ST	ST	ST
	L140 144	greenwich, H	*	ST	ST	ST	ST	ST	ST
	L140 195	nature, H	*	ST	ST	ST	ST	ST	ST

	SHERWOOD V	Front colour	Carcase	Vis. side	W 19	W 100	XW5/ XW6	Plinth	Shelving
	L141 122	black, V	*	ST	ST	ST	ST	ST	ST
	L141 198	burned wood, V	*	ST	ST	ST	ST	ST	-
	L141 142	bushy park, V	*	ST	ST	ST	ST	ST	ST
	L141 092	cigar, V	*	ST	ST	ST	ST	ST	ST
	L141 093	engadina, V	*	ST	ST	ST	ST	ST	ST
	L141 203	graphite, V	*	ST	ST	ST	ST	ST	ST
	L141 144	greenwich, V	*	ST	ST	ST	ST	ST	ST
	L141 195	nature, V	*	ST	ST	ST	ST	ST	ST



Front: Thick-film melamine with deep synchronous pore structure and **horizontally/vertically** grain run, 1.0 mm PP edge all around, backside in same colour.

Handle drilling options

SHERWOOD H+V

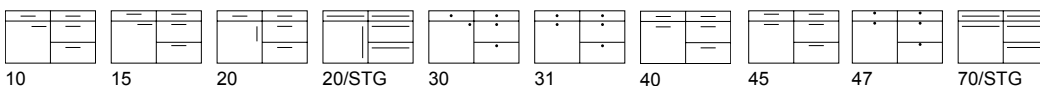

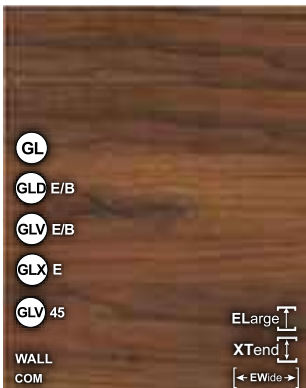

PREMIUM

**Glass doors**

G/GA/GM/R Framed glass door,  
L Door with vertical side stiles

SMART H COM	Front colour	Carcase	Vis. side	W 19	W50+100	XW5/ XW6	Plinth	Shelving
P148 153 P279 153	vic. oak claire, <b>H</b>	-	WL	WL	WL	WL	WL	WL
P148 216 P279 216	walnut, <b>H</b>	KS	-	ST	ST	ST	ST	ST

SMART V COM	Front colour	Carcase	Vis. side	W 19	W50+100	XW5/ XW6	Plinth	Shelving
P149 153 P280 153	vic. oak claire, <b>V</b>	-	WL	WL	WL	WL	WL	WL
P149 216 P280 216	walnut, <b>V</b>	KS	-	ST	ST	ST	ST	ST



LITE

**Glass doors**

Only universal glass doors available

SMART H	Front colour	Carcase	Vis. side	W 19	W50+100	XW5/ XW6	Plinth	Shelving
L148 153	vic. oak claire, <b>H</b>	*	WL	WL	WL	WL	WL	WL
L148 216	walnut, <b>H</b>	*	ST	ST	ST	ST	ST	ST

SMART V	Front colour	Carcase	Vis. side	W 19	W50+100	XW5/ XW6	Plinth	Shelving
L149 153	vic. oak claire, <b>V</b>	*	WL	WL	WL	WL	WL	WL
L149 216	walnut, <b>V</b>	*	ST	ST	ST	ST	ST	ST



NEW

**Glass doors**

R Framed glass door,  
L Door with vertical side stiles

SMART H	Front colour	Carcase	Vis. side	W 19	W50+100	XW5/ XW6	Plinth	Shelving
N148 153	vic. oak claire, <b>H</b>	*	WL	WL	-	WL	WL	WL
N148 216	walnut, <b>H</b>	*	ST	ST	-	ST	ST	ST

SMART V	Front colour	Carcase	Vis. side	W 19	W50+100	XW5/ XW6	Plinth	Shelving
N149 153	vic. oak claire, <b>V</b>	*	WL	WL	-	WL	WL	WL
N149 216	walnut, <b>V</b>	*	ST	ST	-	ST	ST	ST



vic. oak claire, **H** walnut, **H**



vic. oak claire, **V** walnut, **V**

Front: Melamine decor with different wood grains (**horizontal/vertical**) and PP edge, colour-matching back panel

Handle drilling options

SMART H+V

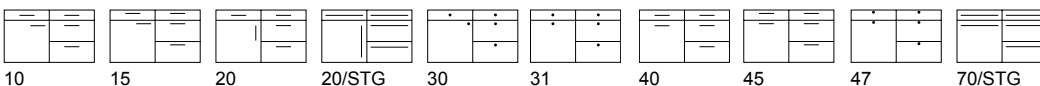



PREMIUM

	CEMENTO	COM	Front colour	Carcase	Vis. side	W 19	W 100	XW5/ XW6	Plinth	Shelving
GLV 45	P170 205	P270 205	amber	*	ST	ST	ST	ST	ST	ST
GLV 45	P170 096	P270 096	basalt dunkel	*	ST	ST	ST	ST	ST	ST
GLV 45	P170 022	P270 022	black	KS	ST	ST	ST	ST	ST	ST
	P170 039	P270 039	bronze	*	ST	ST	ST	ST	ST	ST
	P170 040	P270 040	light grey	*	ST	ST	ST	ST	ST	ST
GLV 45	P170 097	P270 097	light oxide	*	ST	ST	ST	ST	ST	ST
GLV 45	P170 118	P270 118	steel blue	*	ST	ST	ST	ST	ST	ST

Glass doors

G/GA/GM/R Framed glass door,  
L Door with vertical side stiles



LITE

	CEMENTO	Front colour	Carcase	Vis. side	W 19	W 100	XW5/ XW6	Plinth	Shelving
	L170 205	amber	*	ST	ST	ST	ST	ST	ST
	L170 096	basalt dunkel	*	ST	ST	ST	ST	ST	ST
	L170 022	black	*	ST	ST	ST	ST	ST	ST
	L170 039	bronze	*	ST	ST	ST	ST	ST	ST
	L170 040	light grey	*	ST	ST	ST	ST	ST	ST
	L170 097	light oxide	*	ST	ST	ST	ST	ST	ST
	L170 118	steel blue	*	ST	ST	ST	ST	ST	ST

Glass doors

Only universal glass doors available

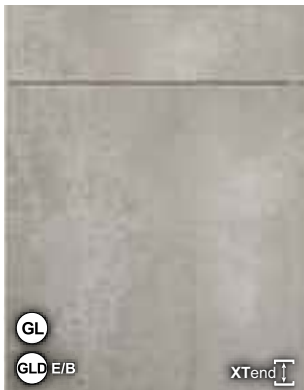

NEW

	CEMENTO	Front colour	Carcase	Vis. side	W 19	W 100	XW5/ XW6	Plinth	Shelving
	N170 205	amber	*	ST	ST	-	ST	ST	ST
	N170 096	basalt dunkel	*	ST	ST	-	ST	ST	ST
	N170 022	black	*	ST	ST	-	ST	ST	ST
	N170 039	bronze	*	ST	ST	-	ST	ST	ST
	N170 040	light grey	*	ST	ST	-	ST	ST	ST
	N170 097	light oxide	*	ST	ST	-	ST	ST	ST
	N170 118	steel blue	*	ST	ST	-	ST	ST	ST

Glass doors

R Framed glass door,  
L Door with vertical side stiles



Front: Thick-film melamine with concrete texture and feel, 1.0 mm PP edge all around, reverse side in the same colour

Handle drilling options

CEMENTO

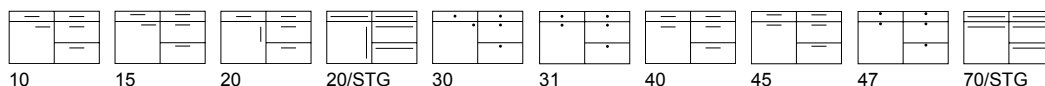

# METALL H/V

## COM

# Melamine

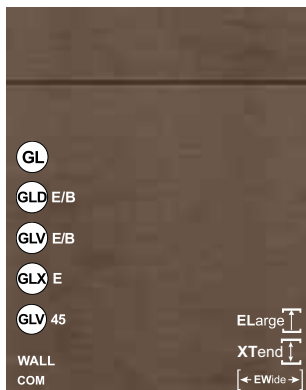

**PREMIUM**

### Glass doors

G/GA/GM/R Framed glass door,  
L Door with vertical side stiles

METALL H	COM	Front colour	Carcase	Vis. side	W 19	W 100	XW5/ XW6	Plinth	Shelving
P233 022	P333 022	black, H	KS	ST	ST	ST	ST	ST	ST
P233 196	P333 196	brown, H	*	ST	ST	ST	ST	ST	ST
P233 060	P333 060	dark steel, H	*	ST	ST	ST	ST	ST	ST
P233 059	P333 059	light umbra, H	*	ST	ST	ST	ST	ST	ST

METALL V	COM	Front colour	Carcase	Vis. side	W 19	W 100	XW5/ XW6	Plinth	Shelving
P234 022	P334 022	black, V	KS	ST	ST	ST	ST	ST	ST
P234 196	P334 196	brown, V	*	ST	ST	ST	ST	ST	ST
P234 060	P334 060	dark steel, V	*	ST	ST	ST	ST	ST	ST
P234 059	P334 059	light umbra, V	*	ST	ST	ST	ST	ST	ST

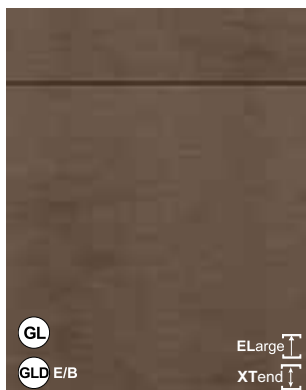

**LITE**

### Glass doors

Only universal glass doors available

METALL H	Front colour	Carcase	Vis. side	W 19	W 100	XW5/ XW6	Plinth	Shelving
L233 022	black, H	*	ST	ST	ST	ST	ST	ST
L233 196	brown, H	*	ST	ST	ST	ST	ST	ST
L233 060	dark steel, H	*	ST	ST	ST	ST	ST	ST
L233 059	light umbra, H	*	ST	ST	ST	ST	ST	ST

METALL V	Front colour	Carcase	Vis. side	W 19	W 100	XW5/ XW6	Plinth	Shelving
L234 022	black, V	*	ST	ST	ST	ST	ST	ST
L234 196	brown, V	*	ST	ST	ST	ST	ST	ST
L234 060	dark steel, V	*	ST	ST	ST	ST	ST	ST
L234 059	light umbra, V	*	ST	ST	ST	ST	ST	ST



black, H    brown, H    dark steel, H    light umbra, H



black, V    brown, V    dark steel, V    light umbra, V

Front: Thick-film melamine, textured metal effect with **horizontally/vertically running** pattern, 1.0 mm PP edge all around, reverse side identical

### Handle drilling options

### METALL H+V

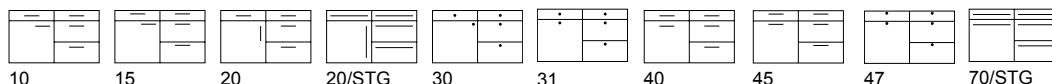

Melamine fronts

Matt-Line

High-gloss Line

Foil-wrapped fronts

Wood Range + Wood Specials

Handles, worktops decors, colour charts and discontinued lines

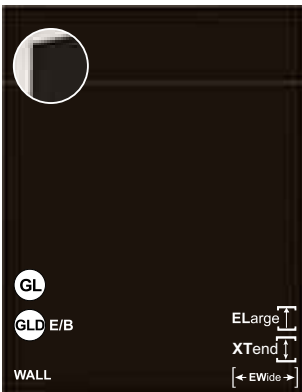

PREMIUM

		Front colour	Carcase	Vis. side	W 19	W50+100	XW5/ XW6	Plinth	Shelving
P275	402	STYLE	Extrem black	KS	XTR	XTR STXTR	XTR	XTR	KS
P355	404	STYLE	Fenix black	KS	SMF	SMF STSMF	SMF	SMF	KS

**Glass doors**

Only universal glass doors available



STYLE EXTREM  
black



STYLE FENIX  
black

Front: Above models with all-round compact-style edge, **W19 panels** available **with same-coloured edge** in XTR/SMF or with fully rounded **compact style-edge (STY)**, see table

Handle drilling options

STYLE

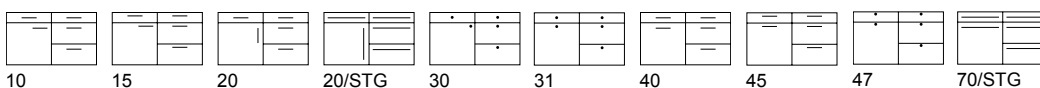



**Matt-Line**

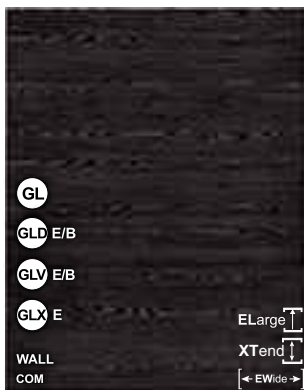

PREMIUM

FEELWOODH COM		Front colour	Carcase	Vis. side	W 19	W 100	XW5/ XW6	Plinth	Shelving
P118 422	P277 422	black, H	KS	ST	ST	ST	ST	ST	ST

FEELWOODV COM		Front colour	Carcase	Vis. side	W 19	W 100	XW5/ XW6	Plinth	Shelving
P119 422	P278 422	black, V	KS	ST	ST	ST	ST	ST	ST

**Glass doors**  
 G/GA/GM/R Framed glass door,  
 L Door with vertical side stiles



LITE

FEELWOOD H		Front colour	Carcase	Vis. side	W 19	W 100	XW5/ XW6	Plinth	Shelving
L118 422		black, H	*	ST	ST	ST	ST	ST	ST

FEELWOOD V		Front colour	Carcase	Vis. side	W 19	W 100	XW5/ XW6	Plinth	Shelving
L119 422		black, V	*	ST	ST	ST	ST	ST	ST

**Glass doors**  
 Only universal glass doors available



black, H



black, V

Front: Feelwood melamine with UV matt-lacquered surface and anti-fingerprint-overlay; horizontal/vertical grain pattern, with same matching decor edge all around, same backside but without anti-fingerprint

Handle drilling options

FEELWOOD H+V

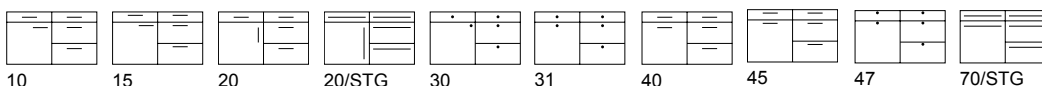



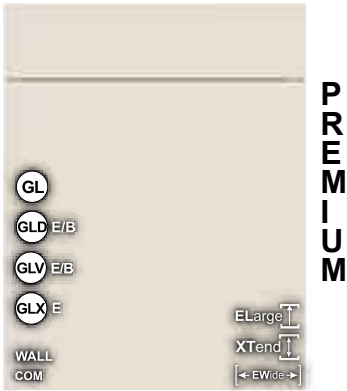

**Glass doors**  
L Door with vertical side stiles

FROST	COM	Front colour	Carcase	Vis. side	W 19	W50+100	XW5/ XW6	Plinth	Shelving
P111 006	P221 006	bianco	KS	SM	SM	SM	SM	SM	SM
P111 090	P221 090	magnolia	KS	SM	SM	SM	SM	SM	SM
P111 007	P221 007	optiwhite	KS	SM	SM	SM	SM	SM	SM
P111 244	P221 244	shell	KS	SM	SM	SM	SM	SM	SM



**Glass doors**  
Only universal glass doors available

FROST	Front colour	Carcase	Vis. side	W 19	W50+100	XW5/ XW6	Plinth	Shelving
L111 006	bianco	KS	SM	SM	SM	SM	SM	SM
L111 090	magnolia	*	SM	SM	SM	SM	SM	SM
L111 007	optiwhite	*	SM	SM	SM	SM	SM	SM
L111 244	shell	*	SM	SM	SM	SM	SM	SM



**Glass doors**  
L Door with vertical side stiles

FROST	Front colour	Carcase	Vis. side	W 19	W50+100	XW5/ XW6	Plinth	Shelving
N111 006	bianco	KS	SM	SM	-	SM	SM	SM
N111 090	magnolia	*	SM	SM	-	SM	SM	SM
N111 007	optiwhite	*	SM	SM	-	SM	SM	SM
N111 244	shell	*	SM	SM	-	SM	SM	SM



Front: HPL matt, with zero joint edge all around, reverse side in the same colour

Handle drilling options

FROST

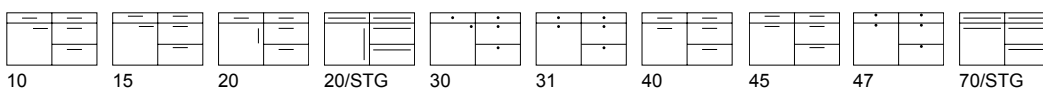

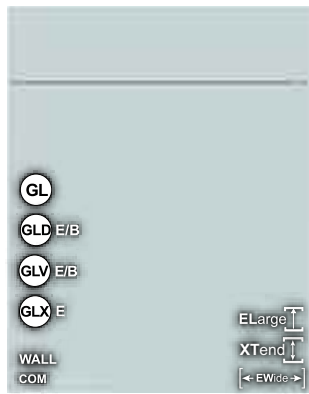

**Glass doors**  
L Door with vertical side stiles

OPACO	COM	Front colour	Carcase	Vis. side	W 19	W50+100	XW5/ XW6	Plinth	Shelving
P232 250	P332 250	aqua	*	UVM	UVM	-	UVM	UVM	-
P232 006	P332 006	bianco	KS	UVM	UVM	-	UVM	UVM	KS
P232 022	P332 022	black	KS	UVM	UVM	-	UVM	UVM	KS
P232 063	P332 063	carbon	KS	UVM	UVM	-	UVM	UVM	KS
P232 129	P332 129	crush gold	*	UVM	UVM	-	UVM	UVM	-
P232 123	P332 123	dolphin	KS	UVM	UVM	-	UVM	UVM	KS
P232 014	P332 014	fango	-	UVM	UVM	-	UVM	UVM	KS
P232 024	P332 024	cashmere	KS	UVM	UVM	-	UVM	UVM	KS
P232 064	P332 064	pebble-grey	KS	UVM	UVM	-	UVM	UVM	KS
P232 251	P332 251	laguna	*	UVM	UVM	-	UVM	UVM	-
P232 111	P332 111	ocean	*	UVM	UVM	-	UVM	UVM	-
P232 128	P332 128	slate	KS	UVM	UVM	-	UVM	UVM	KS
P232 101	P332 101	snow	KS	UVM	UVM	-	UVM	UVM	KS
P232 109	P332 109	steel gold-brown	*	UVM	UVM	-	UVM	UVM	-

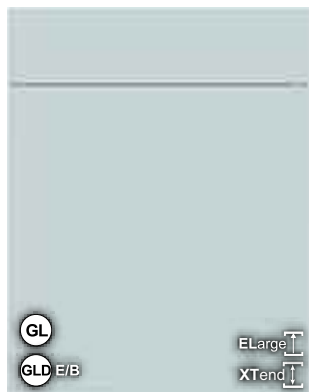

**Glass doors**  
Only universal glass doors available

OPACO	Front colour	Carcase	Vis. side	W 19	W50+100	XW5/ XW6	Plinth	Shelving
L232 250	aqua	*	UVM	UVM	-	UVM	UVM	-
L232 006	bianco	KS	UVM	UVM	-	UVM	UVM	KS
L232 022	black	*	UVM	UVM	-	UVM	UVM	KS
L232 063	carbon	KS	UVM	UVM	-	UVM	UVM	KS
L232 129	crush gold	*	UVM	UVM	-	UVM	UVM	-
L232 123	dolphin	KS	UVM	UVM	-	UVM	UVM	KS
L232 014	fango	*	UVM	UVM	-	UVM	UVM	KS
L232 024	cashmere	*	UVM	UVM	-	UVM	UVM	KS
L232 064	pebble-grey	*	UVM	UVM	-	UVM	UVM	KS
L232 251	laguna	*	UVM	UVM	-	UVM	UVM	-
L232 111	ocean	*	UVM	UVM	-	UVM	UVM	-
L232 128	slate	KS	UVM	UVM	-	UVM	UVM	KS
L232 101	snow	*	UVM	UVM	-	UVM	UVM	KS
L232 109	steel gold-brown	*	UVM	UVM	-	UVM	UVM	-



Front: UV matt lacquered surface with anti-fingerprint overlay, 1.0 mm zero joint edge all around, reverse side in the same colour  
**Note:**  
19 mm panels UV lacquered on the one side, reverse side in the same colour

Handle drilling options

OPACO

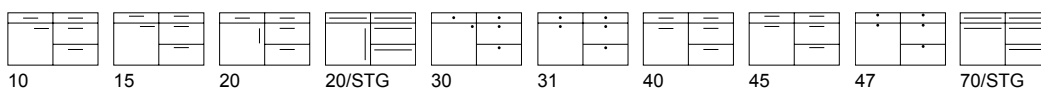

# EXTREM

COM

# HPL matt



PREMIUM

EXTREM	COM	Front colour	Carcase	Vis. side	W 19	W50+100	XW5/ XW6	Plinth	Shelving
P385 022	P485 022	black	KS	XTR	XTR	XTR	XTR	XTR	KS
P385 017	P485 017	graphite	KS	XTR	XTR	XTR	XTR	XTR	KS
P385 007	P485 007	optiwhite	KS	XTR	XTR	XTR	XTR	XTR	KS
P385 243	P485 243	orion	KS	XTR	XTR	XTR	XTR	XTR	KS
P385 244	P485 244	shell	KS	XTR	XTR	XTR	XTR	XTR	KS
P385 101	P485 101	snow	KS	XTR	XTR	XTR	XTR	XTR	KS

### Glass doors

L Door with vertical side stiles

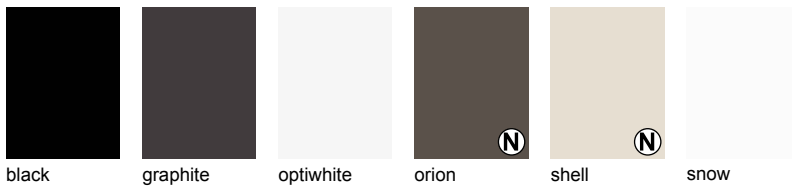

Front: HPL front with extremely matt surface and anti-fingerprint overlay with enormous depth of colour, 1.0 mm zero joint edge all around, reverse side in the same colour

### Handle drilling options

EXTREM

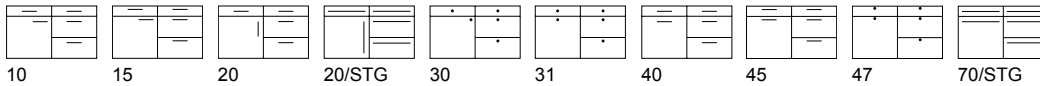

# URBAN

COM

# HPL soft cement

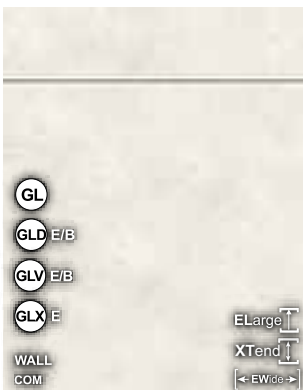

PREMIUM

URBAN	COM	Front colour	Carcase	Vis. side	W 19	W50+100	XW5/ XW6	Plinth	Shelving
P265 062	P365 062	cement white	*	SZ	SZ	SZ	SZ	SZ	-

### Glass doors

L Door with vertical side stiles



Front: HPL matt with cement texture and PP edge all around, reverse side identical

### Handle drilling options

URBAN

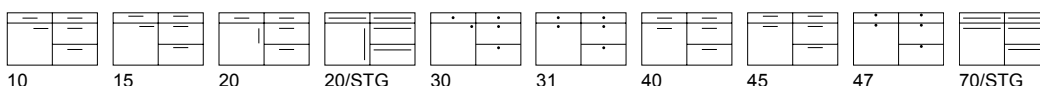

Melamine fronts

Matt-Line

High-gloss Line

Foil-wrapped fronts

Wood Range + Wood Specials

Handles, worktops decors, colour charts and discontinued lines



POMP	Front colour	Carcase	Vis. side	W 19	W50+100	XW5/ XW6	Plinth	Shelving
P476 410	copper	*	ML	ML*	-	-	ML	-
P476 413	copper crumble	*	ML	ML*	-	-	ML	-
P476 411	gold	*	ML	ML*	-	-	ML	-
P476 412	gold crumble	*	ML	ML*	-	-	ML	-

\* Front always displays metal side, backside in anthracite!

**Glass doors**

Only universal glass doors available



Front: MDF front with metal foil over the whole surface and subsequent transparent matt lacquering. Foil contains real metal. Four-sided ABS edge. Rear side door always anthracite. Therefore, we recommend the carcass colour to be graphite.

Handle drilling options

POMP

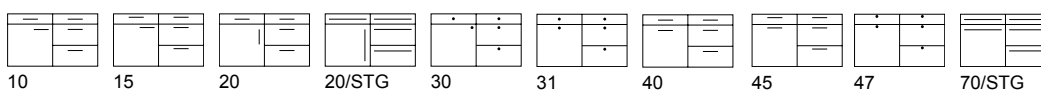

# FENIX

## COM

## HPL matt

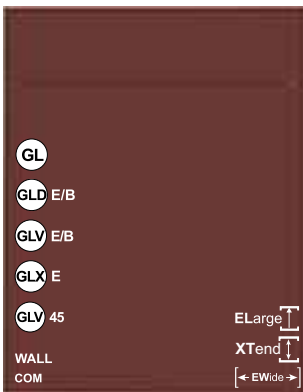

P R E M I U M

### Glass doors

L Door with vertical side stiles

FENIX	COM	Front colour	Carcase	Vis. side	W 19	W 50	XW5/ XW6	Plinth	Shelving
P310 006	P510 006	bianco	KS	SM/SMF	SM/SMF	SM/SMF	SMF	SM/SMF	SM
P310 022	P510 022	black	KS	SMF	SMF	SMF	SMF	SMF	-
P310 134	P510 134	bromo	*	SMF	SMF	SMF	SMF	SMF	-
P310 135	P510 135	cacao	*	SMF	SMF	SMF	SMF	SMF	-
P310 091	P510 091	lightgrey	*	SMF	SMF	SMF	SMF	SMF	-
P310 034	P510 034	kos white	KS	SM/SMF	SM/SMF	SM/SMF	SMF	SM/SMF	SM
P310 044	P510 044	londra	*	SMF	SMF	SMF	SMF	SMF	-
P310 110	P510 110	midnight blue	*	SMF	SMF	SMF	SMF	SMF	-
P310 007	P510 007	optiwhite	KS	SM/SMF	SM/SMF	SM/SMF	SMF	SM/SMF	SM
P310 136	P510 136	rosso	*	SMF	SMF	SMF	SMF	SMF	-
P310 137	P510 137	verde	*	SMF	SMF	SMF	SMF	SMF	-

### SPECIAL FEATURES OF FENIX

Lightfast, wipe-proof, resistant to acidic cleaning agents, Nanotech coating, extremely matt surface, soft touch, anti-fingerprint, antibacterial, antistatic, resistant to scratches and abrasions, scratches can be removed using a dirt eraser or hot iron at 80°C.



Front: HPL matt with outstanding characteristics, with zero joint edge all around, reverse side in the same colour

### Handle drilling options

### FENIX

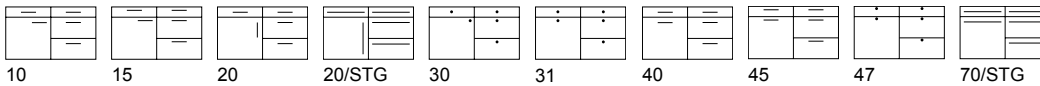

# ART-GLAS MATT

## Matt acrylic



P R E M I U M

### Glass doors

Only universal glass doors available

ART-GLAS MATT	Front colour	Carcase	Vis. side	W 19	W50+100	XW5/ XW6	Plinth	Shelving
P383 179	aureo	KS pebble-grey	ACM	ACM*	-	ACM	ACM	KS pebble-grey
P383 006	bianco	KS bianco	ACM	ACM*	-	ACM	ACM	KS bianco
P383 022	black	KS black	ACM	ACM*	-	ACM	ACM	KS black
P383 017	graphite	KS graphite	ACM	ACM*	-	ACM	ACM	KS graphite
P383 181	luminoso	*	ACM	ACM*	-	ACM	ACM	*
P383 180	opale	*	ACM	ACM*	-	ACM	ACM	*
P383 101	snow	KS snow	ACM	ACM*	-	ACM	ACM	KS snow
P383 188	terrificio	*	ACM	ACM*	-	ACM	ACM	-
P383 187	titanio	*	ACM	ACM*	-	ACM	ACM	-

### SPECIAL FEATURES OF ART-GLAS MATT:

- super-matt surface
- 50% lighter
- 10x more breakproof than real glass
- high scratch-resistance
- easy to clean on account of nano properties
- TÜV-approved
- drillable

\*Side panels only available with acrylic on one side, reverse side in same colour!

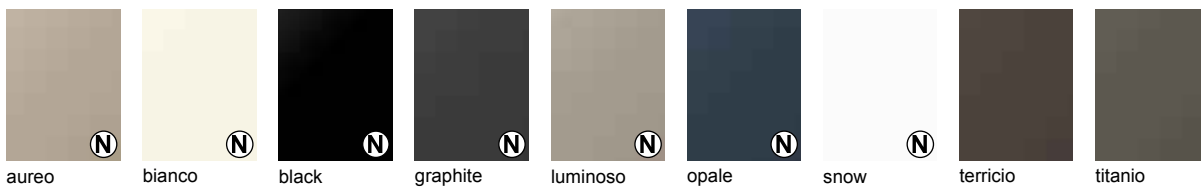

Front: ART-GLAS MATT front in high-quality acrylic with chamfered matt edge, reverse side in same colour.

### Handle drilling options

### ART-GLAS MATT

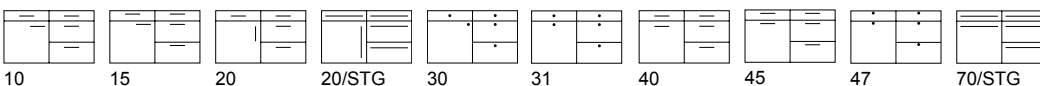

# EFFECTO

COM

# Metallic matt lacquered

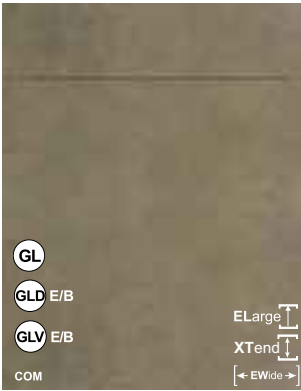

PREMIUM

EFFECTO	COM	Front colour	Carcase	Vis. side	W 19	W50+100	XW5/ XW6	Plinth	Shelving
P506 182	P606 182	bronze dark	*	LM	LM	LM	LM	LM	-
P506 186	P606 186	bronze light	*	LM	LM	LM	LM	LM	-
P506 183	P606 183	silver	*	LM	LM	LM	LM	LM	-
P506 184	P606 184	titanium	*	LM	LM	LM	LM	LM	-

### EVERY FRONT A UNIQUE ONE-OFF

The Eye-catcher is a door style with a surface design with a special-effect lacquer finish which is largely produced by hand. Differences in the sanding pattern or shading, possibly having the effect that the colour shade appears to vary across the front, are no coincidence, but are desired and intended. Solely this method of working and application lends your furniture its unique character and charisma.

### Glass doors

L Door with vertical side stiles

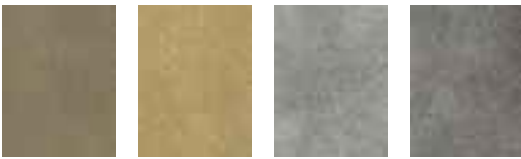

bronze dark    bronze light    silver    titanium

Front: Matt lacquered front with metallic-effect surface and 2 mm radius on all four sides, reverse side colour-matched

### Handle drilling options

EFFECTO

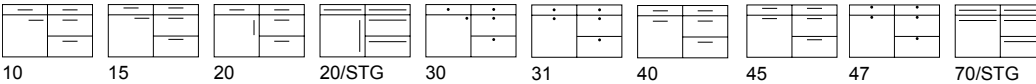

# CONCRETE

# Real concrete surface



PREMIUM

CONCRETE	Front colour	Carcase	Vis. side	W 19	W50+100	XW5/ XW6	Plinth	Shelving
P522 161	clair-light	*	BT	BT	BT	BT	BT	-
P522 163	fonce-dark	*	BT	BT	BT	BT	BT	-
P522 162	moyen-medium	*	BT	BT	BT	BT	BT	-
P522 160	super-bright	*	BT	BT	BT	BT	BT	-

### Glass doors

G/GA/GM/R Framed door,  
L Door with vertical side stiles



clair-light    fonce-dark    moyen-medium    super-bright

Front: MDF front with real concrete surface, reverse side in the same colour.

### Handle drilling options

CONCRETE

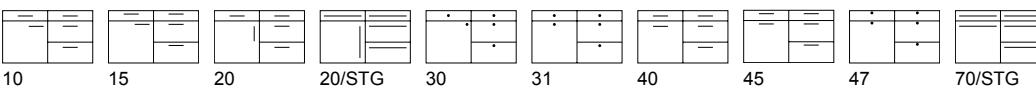

# LUNA R2

COM/RAL

RAL

Matt lacquered

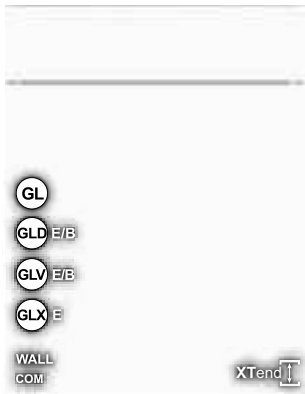

PREMIUM

**Glass doors**  
L Door with vertical side stiles

LUNA R2	COM	Front colour	Carcase	Vis. side	W 19	W 50	XW5/ XW6	Plinth	Shelving
<b>P219</b> 101	<b>P319</b> 101	snow	KS	UM/ML	UM/ML	UM/ML	ML	UM/ML	UM

LUNA R2	RAL COM	Front colour	Carcase	Vis. side	W 19	W 50	XW5/ XW6	Plinth	Shelving
<b>P293</b> 000	<b>P501</b> 000	RAL/Sikkens/NCS	*	ML	ML	ML	ML	ML	-



LITE

**Glass doors**  
Only universal glass doors available

LUNA R2	Front colour	Carcase	Vis. side	W 19	W 50	XW5/ XW6	Plinth	Shelving
<b>L219</b> 101	snow	*	UM/ML	UM/ML	UM/ML	ML	UM/ML	UM



All RAL/Sikkens/NCS colours available.

Individual parts only available on request and at extra charge!  
No metallic colours available!

Please place repeat orders for RAL fronts within 6 months in order to avoid a difference in colour.

Front: Matt lacquered,  
2 mm radius to all four sides, reverse side in the same colour

**XTend** XTend doors with metal strip at the bottom of the door

Handle drilling options

LUNA R2 + RAL

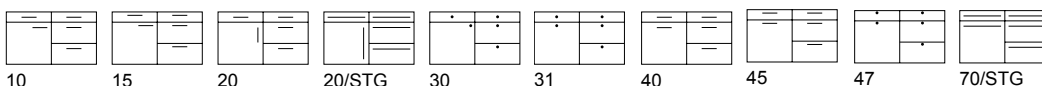

Melamine fronts

Matt-Line

High-gloss Line

Foil-wrapped fronts

Wood Range + Wood Specials

Handles, worktops decors, colour charts and discontinued lines

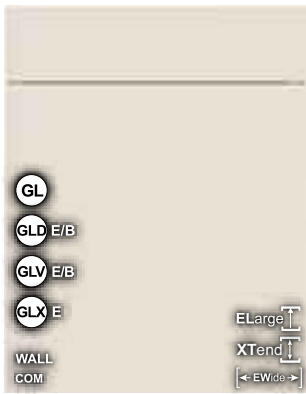

PREMIUM

**Glass doors**  
G/GA/GM/R Framed door,  
L Door with vertical side stiles

LUNA MICRON	COM	Front colour	Carcase	Vis. side	W/WR 19	W 50	XW5/ XW6	Plinth	Shelving
P311 006	P471 006	bianco	KS	MLMi	MLMi	MLMi	MLMi	MLMi	KS
P311 022	P471 022	black	KS	MLMi	MLMi	MLMi	MLMi	MLMi	KS
P311 063	P471 063	carbon	KS	MLMi	MLMi	MLMi	MLMi	MLMi	KS
P311 017	P471 017	graphite	KS	MLMi	MLMi	MLMi	MLMi	MLMi	KS
P311 024	P471 024	cashmere	KS	MLMi	MLMi	MLMi	MLMi	MLMi	KS
P311 064	P471 064	pebble-grey	KS	MLMi	MLMi	MLMi	MLMi	MLMi	KS
P311 044	P471 044	londra	*	MLMi	MLMi	MLMi	MLMi	MLMi	-
P311 208	P471 208	marone	*	MLMi	MLMi	MLMi	MLMi	MLMi	-
P311 110	P471 110	midnight blue	*	MLMi	MLMi	MLMi	MLMi	MLMi	-
P311 112	P471 112	moos	*	MLMi	MLMi	MLMi	MLMi	MLMi	-
P311 032	P471 032	olive	*	MLMi	MLMi	MLMi	MLMi	MLMi	-
P311 243	P471 243	orion	KS	MLMi	MLMi	MLMi	MLMi	MLMi	KS
P311 209	P471 209	seta	*	MLMi	MLMi	MLMi	MLMi	MLMi	-
P311 244	P471 244	shell	KS	MLMi	MLMi	MLMi	MLMi	MLMi	KS
P311 101	P471 101	snow	KS	MLMi	MLMi	MLMi	MLMi	MLMi	KS
P311 113	P471 113	fir green	*	MLMi	MLMi	MLMi	MLMi	MLMi	-
P311 210	P471 210	urbano	*	MLMi	MLMi	MLMi	MLMi	MLMi	-
<b>RAL</b>									
P503 000		RAL/Sikkens/NCS	*	MLMi	MLMi	MLMi	MLMi	MLMi	-

Luna Micron RAL-COM is not available!

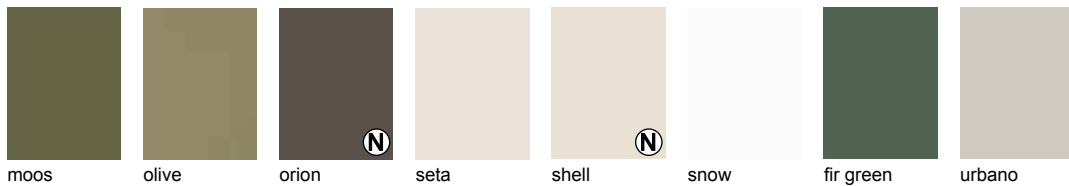

Front: Micron-textured lacquer on MDF with 2 mm radius, reverse side in the same colour



All RAL/Sikkens/NCS colours available.

Individual parts only available on request and at extra charge!  
No metallic colours available!

Please place repeat orders for RAL fronts within 6 months in order to avoid a difference in colour.

Handle drilling options

LUNA MICRON

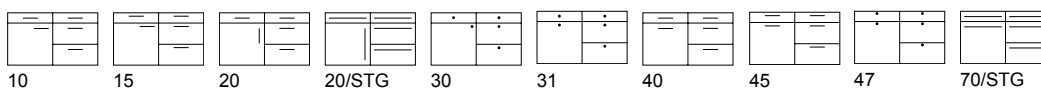



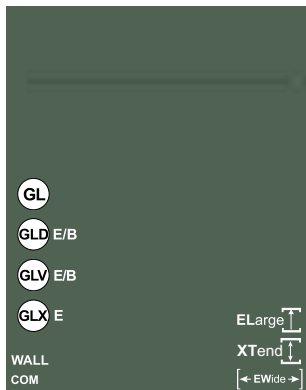

**PREMIUM**

### Glass doors

G/GA/GM/R Framed glass door, L Door with vertical side stiles

LUNA SOFT	COM	Front colour	Carcase	Vis. side	W/WR 19	W 50	XW5/ XW6	Plinth	Shelving
P340 006	P540 006	bianco	KS	MLSO	MLSO	MLSO	MLSO	MLSO	KS
P340 022	P540 022	black	KS	MLSO	MLSO	MLSO	MLSO	MLSO	KS
P340 063	P540 063	carbon	KS	MLSO	MLSO	MLSO	MLSO	MLSO	KS
P340 017	P540 017	graphite	KS	MLSO	MLSO	MLSO	MLSO	MLSO	KS
P340 024	P540 024	cashmere	KS	MLSO	MLSO	MLSO	MLSO	MLSO	KS
P340 064	P540 064	pebble-grey	KS	MLSO	MLSO	MLSO	MLSO	MLSO	KS
P340 044	P540 044	londra	*	MLSO	MLSO	MLSO	MLSO	MLSO	-
P340 208	P540 208	marone	*	MLSO	MLSO	MLSO	MLSO	MLSO	-
P340 110	P540 110	midnight blue	*	MLSO	MLSO	MLSO	MLSO	MLSO	-
P340 112	P540 112	moos	*	MLSO	MLSO	MLSO	MLSO	MLSO	-
P340 032	P540 032	olive	*	MLSO	MLSO	MLSO	MLSO	MLSO	-
P340 243	P540 243	orion	KS	MLSO	MLSO	MLSO	MLSO	MLSO	KS
P340 209	P540 209	seta	*	MLSO	MLSO	MLSO	MLSO	MLSO	-
P340 244	P540 244	shell	KS	MLSO	MLSO	MLSO	MLSO	MLSO	KS
P340 101	P540 101	snow	KS	MLSO	MLSO	MLSO	MLSO	MLSO	KS
P340 113	P540 113	fir green	*	MLSO	MLSO	MLSO	MLSO	MLSO	-
P340 210	P540 210	urbano	*	MLSO	MLSO	MLSO	MLSO	MLSO	-

### Features of anti-fingerprint matt lacquer:

- ultra-matt appearance
- pleasant velvety soft feel
- anti-reflective
- absolutely fingerprint-proof

### Note:

- Lacquer is impact-resistant to a limited extent only



bianco    black    carbon    graphite    cashmere    pebble-grey    londra    marone    midnight blue

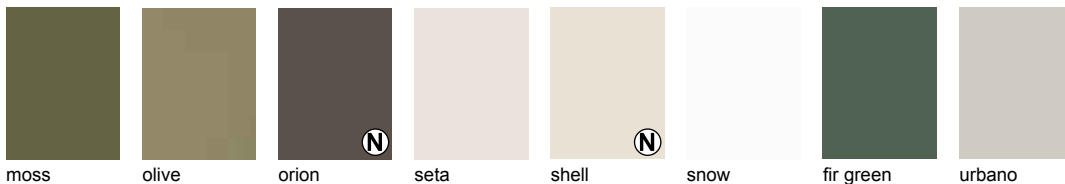

moss    olive    orion    seta    shell    snow    fir green    urbano

Front: matt lacquer with **anti-fingerprint** protection on MDF with 2 mm radius, reverse in same colour

### Handle drilling options

### LUNA SOFT

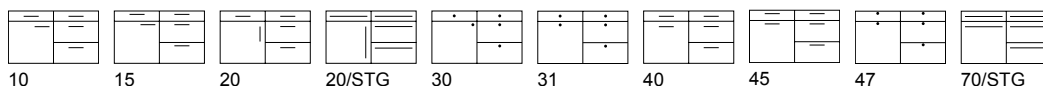

10    15    20    20/STG    30    31    40    45    47    70/STG



PREMIUM

### Glass doors

R Framed glass door  
Framed door up to max.1690 mm  
from one piece

INSPIRATION SOFT	Front colour	Carcase	Vis. side	W/WR 19	W 50	KL/LL	Plinth	Shelving
P423 006	bianco	KS	MLSO	MLSO	MLSO	-	MLSO	KS
P423 022	black	KS	MLSO	MLSO	MLSO	-	MLSO	KS
P423 063	carbon	KS	MLSO	MLSO	MLSO	-	MLSO	KS
P423 017	graphite	KS	MLSO	MLSO	MLSO	-	MLSO	KS
P423 024	cashmere	KS	MLSO	MLSO	MLSO	-	MLSO	KS
P423 064	pebble-grey	KS	MLSO	MLSO	MLSO	-	MLSO	KS
P423 044	londra	*	MLSO	MLSO	MLSO	-	MLSO	-
P423 208	marone	*	MLSO	MLSO	MLSO	-	MLSO	-
P423 110	midnight blue	*	MLSO	MLSO	MLSO	-	MLSO	-
P423 112	moss	*	MLSO	MLSO	MLSO	-	MLSO	-
P423 032	olive	*	MLSO	MLSO	MLSO	-	MLSO	-
P423 243	orion	KS	MLSO	MLSO	MLSO	-	MLSO	KS
P423 209	seta	*	MLSO	MLSO	MLSO	-	MLSO	-
P423 244	shell	KS	MLSO	MLSO	MLSO	-	MLSO	KS
P423 101	snow	KS	MLSO	MLSO	MLSO	-	MLSO	KS
P423 113	fir green	*	MLSO	MLSO	MLSO	-	MLSO	-
P423 210	urbano	*	MLSO	MLSO	MLSO	-	MLSO	-

### Features of anti-fingerprint matt lacquer:

- ultra-matt appearance
- pleasant velvety soft feel
- anti-reflective
- absolutely fingerprint-proof

### Note:

- Lacquer is impact-resistant to a limited extent only
- Front shaped side panels are only available in smooth version, please order matching colours from the Luna programme



bianco black carbon graphite cashmere pebble-grey londra marone midnight blue

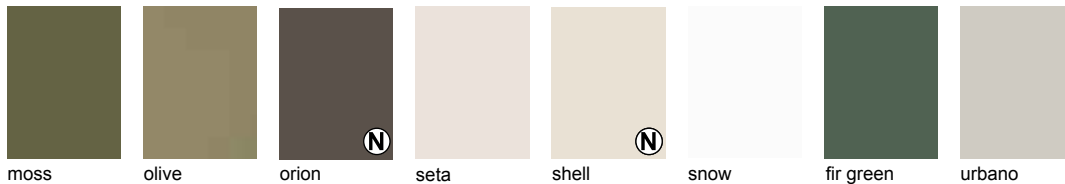

moss olive orion seta shell snow fir green urbano

Front: matt lacquer with **anti-fingerprint** protection as single frame with 45° chamfer on MDF with 2 mm radius, reverse in same colour

### Handle drilling options

### INSPIRATION SOFT

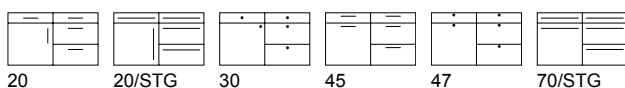



PREMIUM

### Glass doors

R Framed glass door  
Framed door up to max. 1690 mm  
from one piece

ELEGANCE SOFT	Front colour	Carcase	Vis. side	W/WR 19	W 50	KL/LL	Plinth	Shelving
P424 006	bianco	KS	MLSO	MLSO	MLSO	-	MLSO	KS
P424 022	black	KS	MLSO	MLSO	MLSO	-	MLSO	KS
P424 063	carbon	KS	MLSO	MLSO	MLSO	-	MLSO	KS
P424 017	graphite	KS	MLSO	MLSO	MLSO	-	MLSO	KS
P424 024	cashmere	KS	MLSO	MLSO	MLSO	-	MLSO	KS
P424 064	pebble-grey	KS	MLSO	MLSO	MLSO	-	MLSO	KS
P424 044	londra	*	MLSO	MLSO	MLSO	-	MLSO	-
P424 208	marone	*	MLSO	MLSO	MLSO	-	MLSO	-
P424 110	midnight blue	*	MLSO	MLSO	MLSO	-	MLSO	-
P424 112	moss	*	MLSO	MLSO	MLSO	-	MLSO	-
P424 032	olive	*	MLSO	MLSO	MLSO	-	MLSO	-
P424 243	orion	KS	MLSO	MLSO	MLSO	-	MLSO	KS
P424 209	seta	*	MLSO	MLSO	MLSO	-	MLSO	-
P424 244	shell	KS	MLSO	MLSO	MLSO	-	MLSO	KS
P424 101	snow	KS	MLSO	MLSO	MLSO	-	MLSO	KS
P424 113	fir green	*	MLSO	MLSO	MLSO	-	MLSO	-
P424 210	urbano	*	MLSO	MLSO	MLSO	-	MLSO	-

### Features of anti-fingerprint matt lacquer:

- ultra-matt appearance
- pleasant velvety soft feel
- anti-reflective
- absolutely fingerprint-proof

### Note:

- Lacquer is impact-resistant to a limited extent only
- Front shaped side panels are only available in smooth version, please order matching colours from the Luna programme

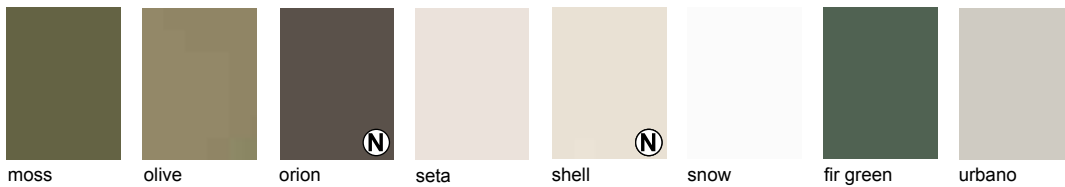

Front: matt lacquer with **anti-fingerprint** protection as double frame on MDF with 2 mm radius, reverse in same colour

### Handle drilling options

### ELEGANCE SOFT

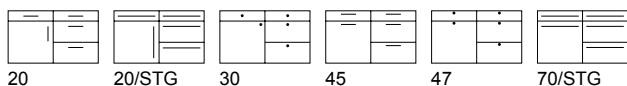



P  
R  
E  
M  
I  
U  
M

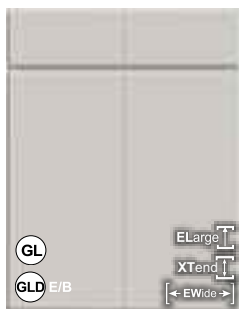

**UNO**  
One vertical groove  
in the middle



**R15**  
Vertical groove spacing  
150 mm  
**Note:**  
The following front widths  
have special groove  
spacings:  
40+80 cm = 132 mm  
50+100 cm = 165 mm

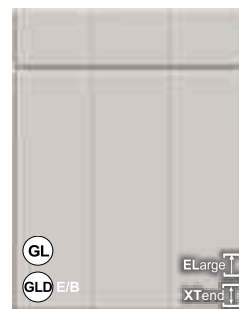

**R20**  
Vertical groove spacing  
200 mm  
**Note:**  
The following front widths  
have special groove  
spacings:  
30 cm = 148 mm  
45+90 cm = 223 mm  
50 cm = 248 mm

**Glass doors**

R Framed glass door,  
L Door with vertical side stiles

**Features of anti-fingerprint matt lacquer:**

- ultra-matt appearance
- pleasant velvety soft feel
- anti-reflective
- absolutely fingerprint-proof

**Note:**

- Lacquer is impact-resistant to a limited extent only
- Front shaped side panels are only available in smooth version, please order matching colours from the Luna programme

ZERO	UNO	R15	R20	Front colour	Carcase	Vis. side	W/WR 19	W 50	KL/LL	Plinth	Shelving
P312 006	P313 006	P314 006	P315 006	bianco	KS	MLSO	MLSO	MLSO	-	MLSO	KS
P312 022	P313 022	P314 022	P315 022	black	KS	MLSO	MLSO	MLSO	-	MLSO	KS
P312 063	P313 063	P314 063	P315 063	carbon	KS	MLSO	MLSO	MLSO	-	MLSO	KS
P312 017	P313 017	P314 017	P315 017	graphite	KS	MLSO	MLSO	MLSO	-	MLSO	KS
P312 024	P313 024	P314 024	P315 024	cashmere	KS	MLSO	MLSO	MLSO	-	MLSO	KS
P312 064	P313 064	P314 064	P315 064	pebble-grey	KS	MLSO	MLSO	MLSO	-	MLSO	KS
P312 044	P313 044	P314 044	P315 044	londra	*	MLSO	MLSO	MLSO	-	MLSO	-
P312 208	P313 208	P314 208	P315 208	marone	*	MLSO	MLSO	MLSO	-	MLSO	-
P312 110	P313 110	P314 110	P315 110	midnight blue	*	MLSO	MLSO	MLSO	-	MLSO	-
P312 112	P313 112	P314 112	P315 112	moos	*	MLSO	MLSO	MLSO	-	MLSO	-
P312 032	P313 032	P314 032	P315 032	olive	*	MLSO	MLSO	MLSO	-	MLSO	-
P312 243	P313 243	P314 243	P315 243	orion	KS	MLSO	MLSO	MLSO	-	MLSO	KS
P312 209	P313 209	P314 209	P315 209	seta	*	MLSO	MLSO	MLSO	-	MLSO	-
P312 244	P313 244	P314 244	P315 244	shell	KS	MLSO	MLSO	MLSO	-	MLSO	KS
P312 101	P313 101	P314 101	P315 101	snow	KS	MLSO	MLSO	MLSO	-	MLSO	KS
P312 113	P313 113	P314 113	P315 113	fir green	*	MLSO	MLSO	MLSO	-	MLSO	-
P312 210	P313 210	P314 210	P315 210	urbano	*	MLSO	MLSO	MLSO	-	MLSO	-

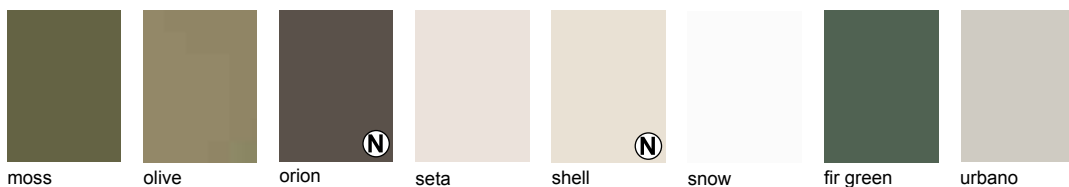
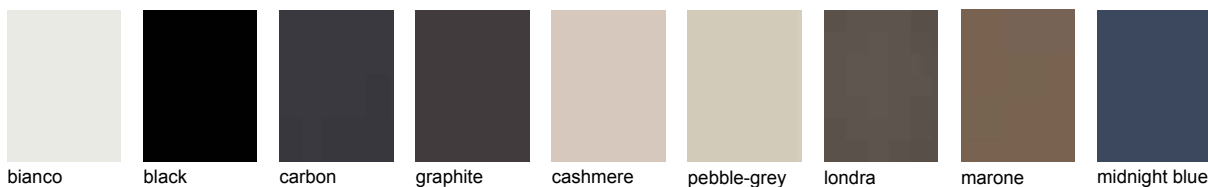

Front: Matt lacquer anti-fingerprint,  
outside with beading, Uno/R15/R20  
models with fine grooving,  
reverse side in same colour.

Handle drilling options

MILA SOFT ZERO

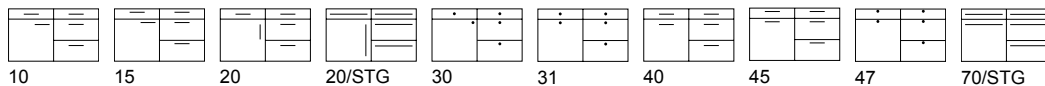

Handle drilling options

MILA SOFT UNO/R15/R20

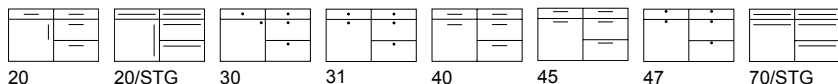



**High-gloss  
Line**



P  
R  
E  
M  
I  
U  
M

**Glass doors**

L Door with vertical side stiles

SILK	COM	Front colour	Carcase	Vis. side	W 19	W50+100	XW5/ XW6	Plinth	Shelving
P109 006	P215 006	bianco	KS	EG	EG	EG	EG	EG	EG
P109 007	P215 007	optiwhite	KS	EG	EG	EG	EG	EG	EG



L  
I  
T  
E

**Glass doors**

Only universal glass doors available

SILK	Front colour	Carcase	Vis. side	W 19	W50+100	XW5/ XW6	Plinth	Shelving
L109 006	bianco	KS	EG	EG	EG	EG	EG	EG
L109 007	optiwhite	*	EG	EG	EG	EG	EG	EG



N  
E  
W

**Glass doors**

L Door with vertical side stiles

SILK	Front colour	Carcase	Vis. side	W 19	W50+100	XW5/ XW6	Plinth	Shelving
N109 006	bianco	KS	EG	EG	-	EG	EG	EG
N109 007	optiwhite	*	EG	EG	-	EG	EG	EG

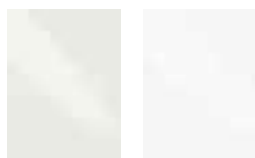

Front: Melamine with fine-gloss surface,  
glossy laser edge all around,  
reverse side in the same colour

bianco      optiwhite

Handle drilling options

SILK

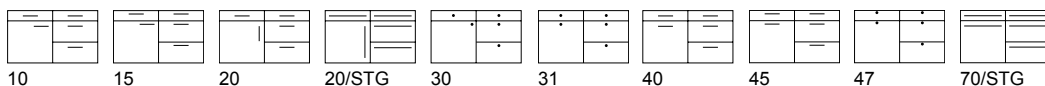



PREMIUM

**Glass doors**

Door with vertical side stiles

ESPRIT	COM	Front colour	Carcase	Vis. side	W 19	W50+100	XW5/ XW6	Plinth	Shelving
P112 006	P225 006	bianco	KS	SG	SG	SG	SG	SG	SG
P112 090	P225 090	magnolia	KS	SG	SG	SG	SG	SG	SG
P112 007	P225 007	optiwhite	KS	SG	SG	SG	SG	SG	SG
P112 101	P225 101	snow	KS	SG	SG	SG	SG	SG	SG



LITE

**Glass doors**

Only universal glass doors available

ESPRIT	Front colour	Carcase	Vis. side	W 19	W50+100	XW5/ XW6	Plinth	Shelving
L112 006	bianco	*	SG	SG	SG	SG	SG	SG
L112 090	magnolia	*	SG	SG	SG	SG	SG	SG
L112 007	optiwhite	*	SG	SG	SG	SG	SG	SG
L112 101	snow	*	SG	SG	SG	SG	SG	SG



NEW

**Glass doors**

L Door with vertical side stiles

ESPRIT	Front colour	Carcase	Vis. side	W 19	W50+100	XW5/ XW6	Plinth	Shelving
N112 006	bianco	KS	SG	SG	-	SG	SG	SG
N112 090	magnolia	*	SG	SG	-	SG	SG	SG
N112 007	optiwhite	*	SG	SG	-	SG	SG	SG
N112 101	snow	*	SG	SG	-	SG	SG	SG



bianco magnolia optiwhite snow

Front: HPL high gloss, zero joint edge all around, reverse side in the same colour

Handle drilling options

ESPRIT

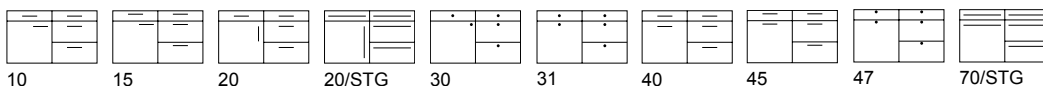

10 15 20 20/STG 30 31 40 45 47 70/STG



PREMIUM

	LUCE	COM	Front colour	Carcase	Vis. side	W 19	W50+100	XW5/ XW6	Plinth	Shelving
GLV 45	P218 006	P353 006	bianco	KS	UVHG/SG	UVHG/SG	SG	UVHG	SG	SG
	P218 095	P353 095	grigio	KS	UVHG	UVHG	-	UVHG	UVHG	-
	P218 024	P353 024	cashmere	KS	UVHG/EG	UVHG/EG	EG	UVHG	EG	EG
GLV 45	P218 007	P353 007	optiwhite	KS	UVHG/SG	UVHG/SG	SG	UVHG	SG	SG
GLV 45	P218 101	P353 101	snow	KS	UVHG/SG	UVHG/SG	SG	UVHG	SG	SG

Glass doors

L Door with vertical side stiles



LITE

	LUCE	Front colour	Carcase	Vis. side	W 19	W50+100	XW5/ XW6	Plinth	Shelving
	L218 006	bianco	KS	UVHG/SG	UVHG/SG	SG	UVHG	SG	SG
	L218 095	grigio	*	UVHG	UVHG	-	UVHG	UVHG	-
	L218 024	cashmere	*	UVHG/EG	UVHG/EG	EG	UVHG	EG	EG
	L218 007	optiwhite	*	UVHG/SG	UVHG/SG	SG	UVHG	SG	SG
	L218 101	snow	*	UVHG/SG	UVHG/SG	SG	UVHG	SG	SG

Glass doors

Only universal glass doors available



NEW

	LUCE	Front colour	Carcase	Vis. side	W 19	W50+100	XW5/ XW6	Plinth	Shelving
	N218 006	bianco	KS	UVHG/SG	UVHG/SG	-	UVHG	SG	SG
	N218 095	grigio	*	UVHG	UVHG	-	UVHG	UVHG	-
	N218 024	cashmere	*	UVHG/EG	UVHG/EG	-	UVHG	EG	EG
	N218 007	optiwhite	*	UVHG/SG	UVHG/SG	-	UVHG	SG	SG
	N218 101	snow	*	UVHG/SG	UVHG/SG	-	UVHG	SG	SG

Glass doors

L Door with vertical side stiles

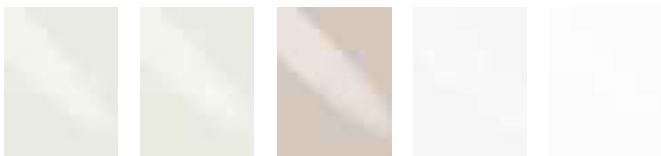

bianco grigio cashmere optiwhite snow

Front: UV lacquered high gloss, laser edge all around, reverse side in the same colour

Handle drilling options

LUCE

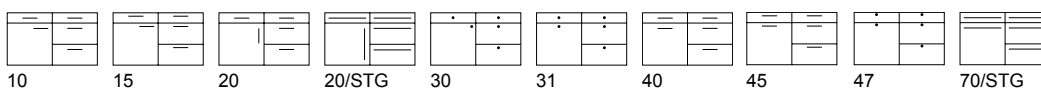





PREMIUM

**Glass doors**  
Only universal glass doors available

LUCE INF.	COM	Front colour	Carcase	Vis. side	W 19	W50+100	XW5/ XW6	Plinth	Shelving
P158 007	P258 007	optiwhite	*	UVHG/SG	UVHG/SG	SG	UVHG	SG	SG
P158 101	P258 101	snow	*	UVHG/SG	UVHG/SG	SG	UVHG	SG	SG



LITE

**Glass doors**  
Only universal glass doors available

LUCE INF.	Front colour	Carcase	Vis. side	W 19	W50+100	XW5/ XW6	Plinth	Shelving
L158 007	optiwhite	*	UVHG/SG	UVHG/SG	SG	UVHG	SG	SG
L158 101	snow	*	UVHG/SG	UVHG/SG	SG	UVHG	SG	SG



NEW

**Glass doors**  
Only universal glass doors available

LUCE INF.	Front colour	Carcase	Vis. side	W 19	W50+100	XW5/ XW6	Plinth	Shelving
N158 007	optiwhite	*	UVHG/SG	UVHG/SG	-	UVHG	SG	SG
N158 101	snow	*	UVHG/SG	UVHG/SG	-	UVHG	SG	SG



Front: UV lacquered high gloss,  
glass-effect laser edge all around,  
reverse side in the same colour

Handle drilling options

LUCE INFINITY

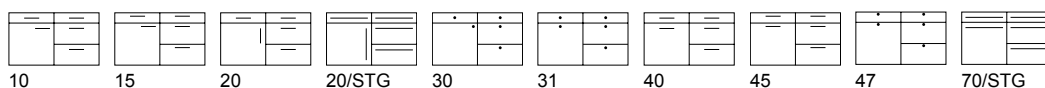

10 15 20 20/STG 30 31 40 45 47 70/STG

# PASSION

COM

RAL

High-gloss lacquered

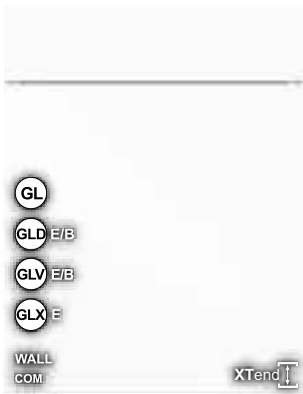

PREMIUM

- GL
- GLD E/B
- GLV E/B
- GLX E
- WALL COM
- XTend

### Glass doors

L Door with vertical side stiles

PASSION	COM	Front colour	Carcase	Vis. side	W 19	W 50	XW5/ XW6	Plinth	Shelving	
P247	101	P357 101	snow	KS	SG/LG	SG/LG	SG/LG	LG	SG/LG	SG
PASSION R2	RAL	Front colour	Carcase	Vis. side	W 19	W 50	XW5/ XW6	Plinth	Shelving	
P557	000	RAL/Sikkens/NCS	*	LG	LG	LG	LG	LG	LG	-

Passion RAL-COM is not available!



LITE

- GL
- GLD E/B
- XTend

### Glass doors

Only universal glass doors available

PASSION	Front colour	Carcase	Vis. side	W 19	W 50	XW5/ XW6	Plinth	Shelving	
L247	101	snow	*	SG/LG	SG/LG	SG/LG	LG	SG/LG	SG

XTend XTend doors with metal strip at the bottom of the door



All RAL/Sikkens/NCS colours available.

Individual parts only available on request and at extra charge! No metallic colours available!

Front: High-gloss lacquered, with 2 mm radius to all four sides, reverse side in the same colour

Please place repeat orders for RAL fronts within 6 months in order to avoid a difference in colour.

snow RAL/Sikkens/NCS colours GL XTend WALL

Handle drilling options

PASSION + RAL

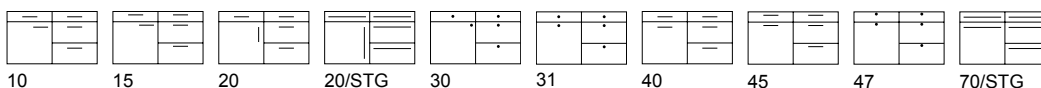



PREMIUM

LUCIDA	COM	Front colour	Carcase	Vis. side	W 19	W 50	XW5/ XW6	Plinth	Shelving
P282 006	P292 006	bianco	KS	SG/LG	SG/LG	SG/LG	LG	SG/LG	SG

**Glass doors**

L Door with vertical side stiles



LITE

LUCIDA	Front colour	Carcase	Vis. side	W 19	W 50	XW5/ XW6	Plinth	Shelving
L282 006	bianco	KS	SG/LG	SG/LG	SG/LG	LG	SG/LG	SG

**Glass doors**

Only universal glass doors available

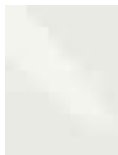

Front: High-gloss lacquered, with 3 mm radius to all four sides, reverse side in the same colour

XTend XTend doors with metal strip at the bottom of the door

bianco

Handle drilling options

LUCIDA

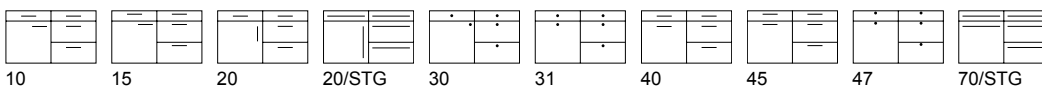



**PREMIUM**

ART-GLAS GLOSS	Front colour	Carcase	Vis. side	W 19	W50+100	XW5/ XW6	Plinth	Shelving
<b>P316 006</b>	bianco	KS	ACG	ACG*	-	ACG	ACG	-
<b>P316 022</b>	black	KS	ACG	ACG*	-	ACG	ACG	-
<b>P316 105</b>	fumo	*	ACG	ACG*	-	ACG	ACG	-
<b>P316 024</b>	cashmere	KS	ACG	ACG*	-	ACG	ACG	-
<b>P316 101</b>	snow	KS	ACG	ACG*	-	ACG	ACG	-

\*Side panels only available with acrylic on one side, reverse side in same colour!

**FEATURES OF ART-GLAS GLOSS:**

- high-gloss depth effect as with real glass
- 50% lighter
- 10x more breakproof than real glass
- high scratch-resistance
- easy to clean on account of nano properties
- TÜV-approved
- drillable

**Glass doors**

Only universal glass doors available

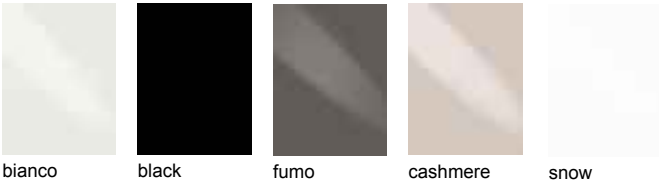

Front: ART-GLAS GLOSS front in high-quality acrylic with chamfered glossy edge, reverse side in the same colour.

**Handle drilling options**

**ART-GLAS GLOSS**

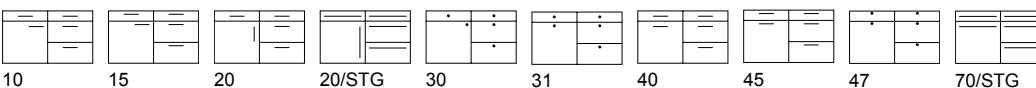



**Foil-wrapped  
fronts**



ZERO  
without grooves

**Glass doors**  
R Framed glass door,  
L Door with vertical side stiles

**PREMIUM**



**UNO**  
One vertical groove  
in the middle



**R20**  
Vertical groove spacing  
200 mm  
**Note:**  
The following front widths  
have special groove  
spacings:  
30 cm = 148 mm  
45+90 cm = 223 mm  
50 cm = 248 mm



**R15**  
Vertical groove spacing  
150 mm  
**Note:**  
The following front widths  
have special groove  
spacings:  
40+80 cm = 132 mm  
50+100 cm = 165 mm

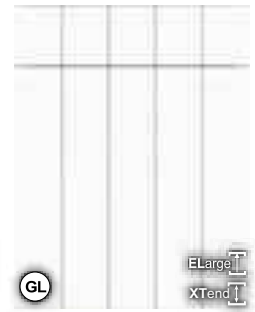

**R10**  
Vertical groove spacing  
100 mm  
**Note:**  
The following front widths  
have special groove  
spacings:  
45 cm = 89 mm

ZERO	UNO	R20	R15	R10	Front colour	Carcase	Vis. side	W 19	W50+100	XW5	Plinth	Shelving
P235 006	P236 006	P239 006	P238 006	P237 006	bianco	KS	-	KS*	KS W100	-	KS	KS
P235 024	P236 024	P239 024	P238 024	P237 024	cashmere	KS	-	KS*	KS	-	KS	KS
P235 090	P236 090	P239 090	P238 090	P237 090	magnolia	KS	-	KS*	KS W100	-	KS	KS

KS\* in this model foil-wrapped side panels 19 mm thick are also available with grooves!

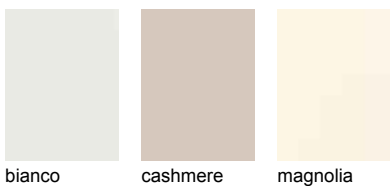

Front: Foil-wrapped model, **matt** surface, with vertically spaced grooves,  
reverse side in the same colour

Handle drilling options **GROOVE MATT ZERO**

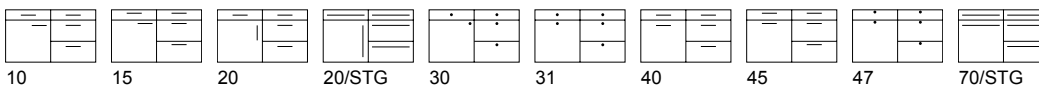

Handle drilling options **GROOVE MATT UNO + R20 + R15 + R10**

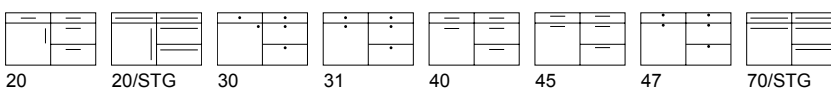

# CASTLE MATT

# Foil-wrapped



PREMIUM

CASTLE MATT	Front colour	Carcase	Vis. side	W 19	Pilasters	OZ 53/54 KL/LL	Plinth	Shelving
P220 006	bianco	KS	-	KS*	K	KS	KS	KS
P220 024	cashmere	KS	-	KS*	K	KS	KS	KS
P220 090	magnolia	KS	-	KS*	K	KS	KS	KS

**Note:**

KS\* in this model foil-wrapped side panels 19 mm thick are also available with grooves!

Pilaster: K = Foil-wrapped pilaster matt (Castle)

**Glass doors**

R Framed glass door,  
L Door with vertical side stiles

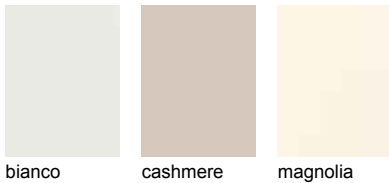

Front: Foil-wrapped Shaker-style door, **matt** surface, with 7 cm frame and grooves, reverse side in the same colour

Handle drilling options CASTLE MATT

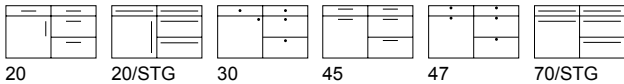

# MEDA MATT

# Foil-wrapped



PREMIUM

MEDA MATT	Front colour	Carcase	Vis. side	W 19	Pilasters	OZ 14/15 OZ 36/37 KL/LL	Plinth	Shelving
P240 006	bianco	KS	-	KS	K	KS	KS	KS
P240 024	cashmere	KS	-	KS	K	KS	KS	KS
P240 090	magnolia	KS	-	KS	K	KS	KS	KS

**Note:**

Pilaster: K = Foil-wrapped pilaster matt (Meda)

Cornice and light pelmet will be matt lacquered in the same colour

**Glass doors**

R Framed glass door,  
L Door with vertical side stiles

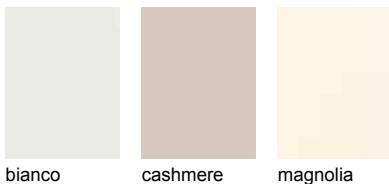

Front: Foil-wrapped Shaker-style door, **matt** surface, with 7 cm frame and chamfer, reverse side in the same colour

Handle drilling options MEDA MATT

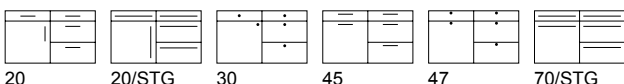



P  
R  
E  
M  
I  
U  
M

MODERNO MATT	Front colour	Carcase	Vis. side	W 19	Pilasters	KL/LL	Plinth	Shelving
P241 006	bianco	KS	-	KS	KS W100	-	KS	KS
P241 024	cashmere	KS	-	KS	KS	-	KS	KS
P241 090	magnolia	KS	-	KS	KS W100	-	KS	KS

**Glass doors**

R Framed glass door,  
L Door with vertical side stiles

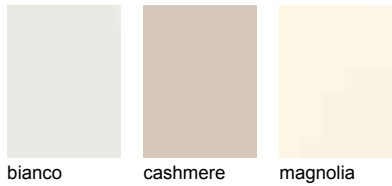

Front: Foil-wrapped model, **matt** surface,  
with 7 cm frame and modern flat centre panel,  
reverse side in the same colour

Handle drilling options

MODERNO MATT

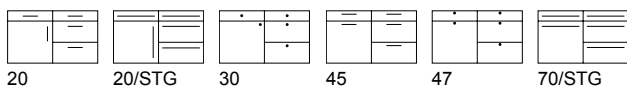





Wood  
Range  
+  
Wood  
Specials

NEW

# Wood Range + Wood Specials overview

---

## Wood Range *Information*

8 programmes available in various structures/surfaces. "Knotty raw", "Knotty brushed", "Striped brushed" and "Silky smart". These programmes are listed starting on page 58.

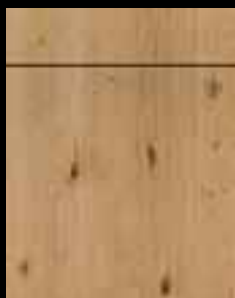

MERINO H/V



SPLIT-PLANK  
OAK V



SPLIT-OAK H/V



LAMELLA



CADRE



TELAIO



STRETTO



TOSCANA

---

## Wood Specials *Information*

8 programmes available in one structure/surface only. These programmes are listed starting on page 66.



ROUGH ZERO+R15



REAL-OAK H/V

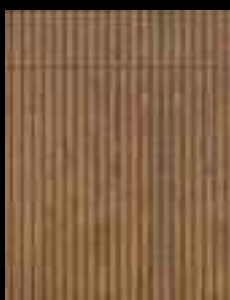

VERTICO V



BLACK STRIPE V



BLACK-LINE



NOTCHO



ORBITA



RIPIENO

# Wood Range + Specials

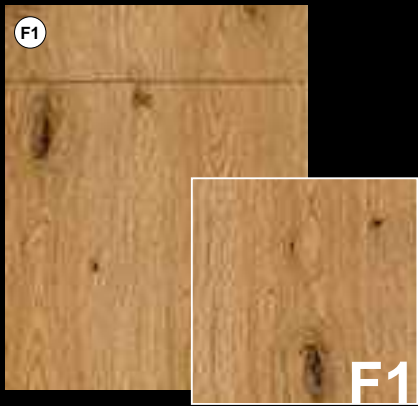

## Knotty raw

Strong veneer, knotty with figure, blasted

**F1** = *Knotty raw*

Model name	Front colour	Carcase	Vis. side	Panels	XW5/ XW6	Plinth	Shelving
P462 102	nature	*	F1	F1/*	F1	F1	



## Knotty brushed

Knotty veneer with figure, brushed

**F2** = *Knotty brushed*

Model name	Front colour	Carcase	Vis. side	Panels	XW5/ XW6	Plinth	Shelving
P462 102	nature	*	F2	F2/*	F2	F2	F2

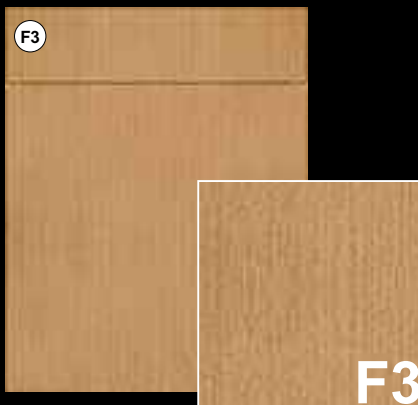

## Striped brushed

Plain Veneer without figure, brushed

**F3** = *Striped brushed*

Model name	Front colour	Carcase	Vis. side	Panels	XW5/ XW6	Plinth	Shelving
P462 102	nature	*	F3	F3/*	F3	F3	F3

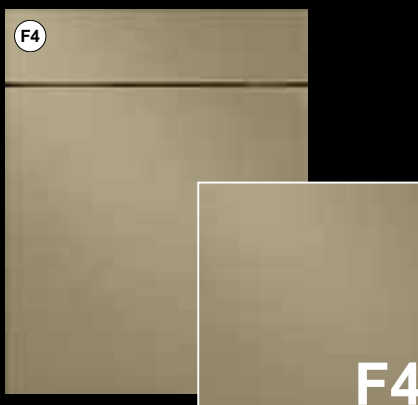

## Silky smart

Silky gloss finish







**F4** = *Silky smart*

Model name	Front colour	Carcase	Vis. side	Panels	XW5/ XW6	Plinth	Shelving
P650 032	olive	*	F4	F4/*	-	F4	F4

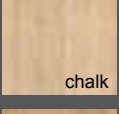
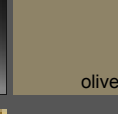
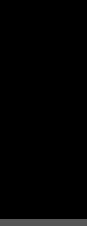
# Wood Range

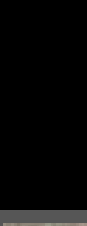
Doortypes	Woodstructures				Woodcolours			Lacquer colours		
	F1	F2	F3	F4						
MERINO H/V					beachwood	chalk		bianco	black	olive
					driftwood	nature	walnut	shell		
SPLIT-PLANK OAK V					chestnut	nature				
SPLIT-OAK H/V					chestnut	nature				
LAMELLA					chalk	chestnut		black		
					nature					
CADRE					chestnut	nature		black		
TELAIO					beachwood	chalk	chestnut	bianco	black	olive
					driftwood	nature		shell		
STRETTO					chestnut	nature		black		
TOSCANA								bianco	black	olive
								shell		

# Wood Specials

Doortypes	Woodstructures				Woodcolours			Lacquer colours
	F1	F2	F3	F4				
 <b>ROUGH ZERO+R15</b>					 black	 graphite	 pastell loam	
					 pastell shadow	 pastell smoke	 plage	
 <b>REAL-OAK H/V</b>					 chalk	 chestnut	 real-nature	
 <b>VERTICO V</b>					 chalk	 chestnut	 driftwood	 bianco
					 nature	 walnut		 black
								 olive
 <b>BLACK STRIPE V</b>					 chestnut	 nature	 walnut	
 <b>BLACK-LINE</b>					 nature			
 <b>NOTCHO</b>					 nature	 walnut	 black	
 <b>ORBITA</b>					 beachwood	 driftwood	 nature	
 <b>RIPIENO</b>					 beachwood	 driftwood	 nature	

Melamine fronts

Matt-Line

High-gloss Line

Foil-wrapped fronts

Wood Range + Wood Specials

Handles, worktops decors, colour charts and discontinued lines



**P  
R  
E  
M  
I  
U  
M**

**ZERO H/V**  
without grooves  
Flat veneered front

**Glass doors**  
G/GA/GM/R Framed glass door only available for the ZERO range,  
L Door with vertical side stiles

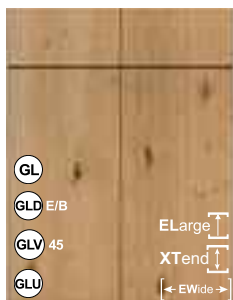

**UNO**  
One vertical groove  
in the middle



**R20**  
Vertical groove spacing  
200 mm  
**Note:**  
The following front  
widths  
have special groove  
spacings:  
30 cm = 148 mm  
45+90 cm = 223 mm  
50 cm = 248 mm

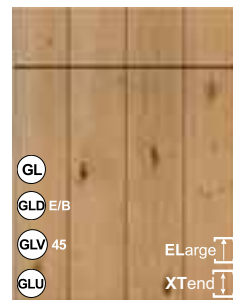

**R15**  
Vertical groove spacing  
150 mm  
**Note:**  
The following front  
widths  
have special groove  
spacings:  
40+80 cm = 132 mm  
50+100 cm = 165 mm



**R10**  
Vertical groove spacing  
100 mm  
**Note:**  
The following front widths  
have special groove  
spacings:  
45 cm = 89 mm



beachwood    chalk    chestnut    driftwood    nature    walnut only F2 + F3



bianco    black    olive    shell

**All RAL/Sikkens/NCS colours available.**

**Individual parts only available on request and at extra charge! No metallic colours available!**

F1\*, F2\*, F3\* side walls are available in grooved (OLWR) or smooth (OLW) version in a thickness of 19, 50, 75 and 100 mm.

Handle drilling options    **MERINO H/V F1, F2, F3 ZERO**

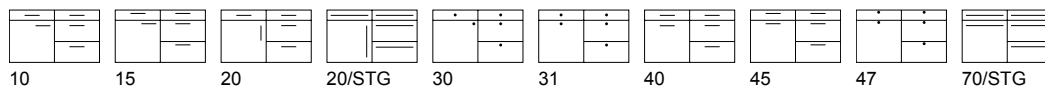

Handle drilling options    **MERINO H/V F1, F2, F3 UNO + R20 + R15 + R10**

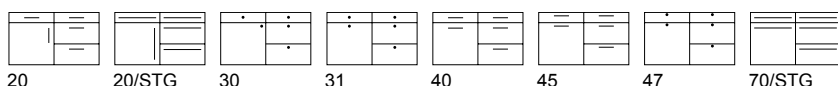

## F1 (previously LEGNO)

## Knotty raw

Front: **Blasted** knotty oak with strong veneer, on raw chipboard, 21 mm thick front, OLW19 = 21 mm thick

ZERO H	ZERO V	UNO	R20	R15	R10	Front colour	Carcase	Vis. side	Panels	XW5/ XW6	Plinth	Shelving
P461 019	P462 019	P465 019	P466 019	P468 019	P469 019	beachwood	*	F1	F1/*	F1	F1	F2
P461 104	P462 104	P465 104	P466 104	P468 104	P469 104	chalk	*	F1	F1/*	F1	F1	F2
P461 121	P462 121	P465 121	P466 121	P468 121	P469 121	chestnut	*	F1	F1/*	F1	F1	F2
P461 031	P462 031	P465 031	P466 031	P468 031	P469 031	driftwood	*	F1	F1/*	F1	F1	F2
P461 102	P462 102	P465 102	P466 102	P468 102	P469 102	nature	*	F1	F1/*	F1	F1	F2
P461 006	P462 006	P465 006	P466 006	P468 006	P469 006	bianco	KS	F1	F1/*	F1	F1	F2
P461 022	P462 022	P465 022	P466 022	P468 022	P469 022	black	KS	F1	F1/*	F1	F1	F2
P461 032	P462 032	P465 032	P466 032	P468 032	P469 032	olive	*	F1	F1/*	F1	F1	F2
P461 244	P462 244	P465 244	P466 244	P468 244	P469 244	shell	KS	F1	F1/*	F1	F1	F2

### RAL

RAL ZERO	RAL ZERO	UNO	R20	R15	R10	Front colour	Carcase	Vis. side	Panels	XW5/ XW6	Plinth	Shelving
P571 000	P572 000	P575 000	P576 000	P578 000	P579 000	RAL-, Sikkens-, NCS	*	F1	F1/*	F1	F1	F2

Shelves are only available in F2 brushed

## F2 (previously MERINO)

## Knotty brushed

Front: **Deeply knotty** oak/walnut

ZERO H	ZERO V	UNO	R20	R15	R10	Front colour	Carcase	Vis. side	Panels	XW5/ XW6	Plinth	Shelving
P401 019	P402 019	P405 019	P406 019	P408 019	P409 019	beachwood	*	F2	F2/*	F2	F2	F2
P401 104	P402 104	P405 104	P406 104	P408 104	P409 104	chalk	*	F2	F2/*	F2	F2	F2
P401 121	P402 121	P405 121	P406 121	P408 121	P409 121	chestnut	*	F2	F2/*	F2	F2	F2
P401 031	P402 031	P405 031	P406 031	P408 031	P409 031	driftwood	*	F2	F2/*	F2	F2	F2
P401 102	P402 102	P405 102	P406 102	P408 102	P409 102	nature	*	F2	F2/*	F2	F2	F2
P401 216	P402 216	P405 216	P406 216	P408 216	P409 216	walnut	*	F2	F2/*	F2	F2	F2

P401 006	P402 006	P405 006	P406 006	P408 006	P409 006	bianco	KS	F2	F2/*	F2	F2	F2
P401 022	P402 022	P405 022	P406 022	P408 022	P409 022	black	KS	F2	F2/*	F2	F2	F2
P401 032	P402 032	P405 032	P406 032	P408 032	P409 032	olive	*	F2	F2/*	F2	F2	F2
P461 244	P402 244	P405 244	P406 244	P408 244	P409 244	shell	KS	F2	F2/*	F2	F2	F2

### RAL

RAL ZERO	RAL ZERO	UNO	R20	R15	R10	Front colour	Carcase	Vis. side	Panels	XW5/ XW6	Plinth	Shelving
P581 000	P582 000	P585 000	P586 000	P588 000	P589 000	RAL-, Sikkens-, NCS	*	F2	F2/*	F2	F2	F2

## F3 (NUEVO)

## Striped brushed

Front: **Brushed plain** oak/walnut, without knots, without figure

ZERO H	ZERO V	UNO	R20	R15	R10	Front colour	Carcase	Vis. side	Panels	XW5/ XW6	Plinth	Shelving
P421 019	P422 019	P425 019	P426 019	P428 019	P429 019	beachwood	*	F3	F3/*	F3	F3	F3
P421 104	P422 104	P425 104	P426 104	P428 104	P429 104	chalk	*	F3	F3/*	F3	F3	F3
P421 121	P422 121	P425 121	P426 121	P428 121	P429 121	chestnut	*	F3	F3/*	F3	F3	F3
P421 031	P422 031	P425 031	P426 031	P428 031	P429 031	driftwood	*	F3	F3/*	F3	F3	F3
P421 102	P422 102	P425 102	P426 102	P428 102	P429 102	nature	*	F3	F3/*	F3	F3	F3
P421 216	P422 216	P425 216	P426 216	P428 216	P429 216	walnut	*	F3	F3/*	F3	F3	F3

P421 006	P422 006	P425 006	P426 006	P428 006	P429 006	bianco	KS	F3	F3/*	F3	F3	F3
P421 022	P422 022	P425 022	P426 022	P428 022	P429 022	black	KS	F3	F3/*	F3	F3	F3
P421 032	P422 032	P425 032	P426 032	P428 032	P429 032	olive	*	F3	F3/*	F3	F3	F3
P421 244	P422 244	P425 244	P426 244	P428 244	P429 244	shell	KS	F3	F3/*	F3	F3	F3

### RAL

RAL ZERO	RAL ZERO	UNO	R20	R15	R10	Front colour	Carcase	Vis. side	Panels	XW5/ XW6	Plinth	Shelving
P491 000	P492 000	P495 000	P496 000	P498 000	P499 000	RAL-, Sikkens-, NCS	*	F3	F3/*	F3	F3	F3

# SPLIT PLANK-OAK V

## F1, F2

### Wood Range



PREMIUM

#### Glass doors

L Door with vertical side stiles



chestnut, V

nature, V

### F1 (previously PLANK-OAK)

Knotty raw

Front: veneered old oak, vertically planked (butting against veneer) and **sandblasted**

SPLIT PLANK-OAK V	Front colour	Carcase	Vis. side	Panels	XW5/ XW6	Plinth	Shelving
P517 121	chestnut, V	*	F1	F1/*	F1	F1	F2
P517 102	nature, V	*	F1	F1/*	F1	F1	F2

Visible side not planked; shelves are only available in F2 **brushed**

### F2 (NEW)

Knotty brushed

Front: veneered old oak, vertically planked (butting against veneer) and **brushed**

SPLIT PLANK-OAK V	Front colour	Carcase	Vis. side	Panels	XW5/ XW6	Plinth	Shelving
P527 121	chestnut, V	*	F2	F2/*	F2	F2	F2
P527 102	nature, V	*	F2	F2/*	F2	F2	F2

Visible side not planked

F1/\*, F2/\* side walls are available in planked (OWLR) or smooth (OLW) version in a thickness of 19, 50, 75 and 100 mm.

#### Handle drilling options

SPLIT PLANK-OAK V F1, F2

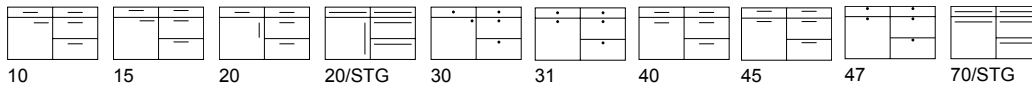

# SPLIT-OAK H/V

## F1, F2

### Wood Range

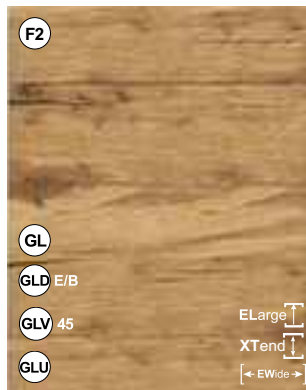

PREMIUM

#### Glass doors

G/GA/GM/R Framed glass door,  
H Framed door, glass at top only



chestnut, H/V

nature, H/V

### F1 (NEW)

Knotty raw

Front: knotty oak veneer, **blasted**

SPLIT OAK H	Front colour	Carcase	Vis. side	Panels	XW5/ XW6	Plinth	Shelving
P523 121	chestnut, H	*	F1	F1/*	F1	F1	F2
P523 102	nature, H	*	F1	F1/*	F1	F1	F2

SPLIT OAK V	Front colour	Carcase	Vis. side	Panels	XW5/ XW6	Plinth	Shelving
P524 121	chestnut, V	*	F1	F1/*	F1	F1	F2
P524 102	nature, V	*	F1	F1/*	F1	F1	F2

Shelves are only available in F2 **brushed**

### F2 (previously SPLIT-OAK)

Knotty brushed

Front: knotty oak veneer, **brushed**

SPLIT OAK H	Front colour	Carcase	Vis. side	Panels	XW5/ XW6	Plinth	Shelving
P543 121	chestnut, H	*	F2	F2/*	F2	F2	F2
P543 102	nature, H	*	F2	F2/*	F2	F2	F2

SPLIT OAK V	Front colour	Carcase	Vis. side	Panels	XW5/ XW6	Plinth	Shelving
P544 121	chestnut, V	*	F2	F2/*	F2	F2	F2
P544 102	nature, V	*	F2	F2/*	F2	F2	F2

#### Handle drilling options

SPLIT OAK H/V F1, F2

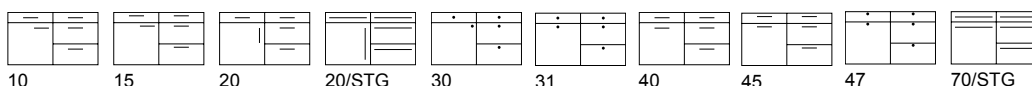





P  
R  
E  
M  
I  
U  
M

**Glass doors**

Only universal glass doors available



black chalk chestnut



All RAL/Sikkens/NCS colours available.

Individual parts only available on request and at extra charge!  
No metallic colours available!

**F2 (previously LAMELLA) Knotty brushed**

Front: oak veneer front, brushed with figure and knots on MDF base board with horizontal lamella direction. The groove between the slats ist 13 mm wide. The front is 21.7 mm thick.

LAMELLA	Front colour	Carcase	Vis. side	Panels	XW5/ XW6	Plinth	Shelving
P652 022	black	KS	F2	F2	F2	F2	F2
P652 104	chalk	*	F2	F2	F2	F2	F2
P652 121	chestnut	*	F2	F2	F2	F2	F2

**RAL**

P653 000	RAL-, Sikkens-, NCS	*	F2	F2	F2	F2	F2
----------	---------------------	---	----	----	----	----	----

Side panels are only available without slats!

**F3 (NEW) Striped brushed**

Front: plain oak veneer front, brushed without figures and knots on MDF base board with horizontal lamella direction. The groove between the slats ist 13 mm wide. The front is 21.7 mm thick.

LAMELLA	Front colour	Carcase	Vis. side	Panels	XW5/ XW6	Plinth	Shelving
P612 022	black	KS	F3	F3	F3	F3	F3
P612 104	chalk	*	F3	F3	F3	F3	F3
P612 121	chestnut	*	F3	F3	F3	F3	F3

**RAL**

P613 000	RAL-, Sikkens-, NCS	*	F3	F3	F3	F3	F3
----------	---------------------	---	----	----	----	----	----

Side panels are only available without slats!

Due to the horizontal grooving GL780 and S126 cannot be combined  
(tall units with vertical GL-strip cannot be combined with handleless base units)

Handle drilling options LAMELLA F2, F3



15 45 47

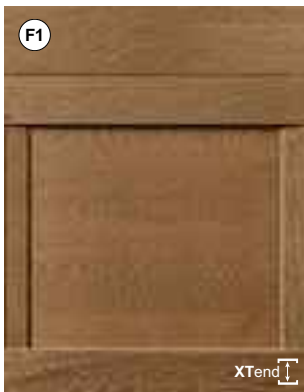

PREMIUM

**Glass doors**

RQ framed glass door with horizontal rail



black chestnut nature



All RAL/Sikkens/NCS colours available.

Individual parts only available on request and at extra charge! No metallic colours available!

**F1 (previously CADRE)**

Knotty raw

Front: 23 mm thick, at top and bottom 9 cm wide solid sandblasted rail, with integral fingerrip recess, sited inbetween on left and right 5.5 cm wide flattened rail, centre panel in wild brushed veneer.

CADRE	Front colour	Carcase	Vis. side	Panels	XW5/ XW6	Plinth	Shelving
P636 022	black	KS	F1	F1/*	-	F1	F2
P636 121	chestnut	*	F1	F1/*	-	F1	F2
P636 102	nature	*	F1	F1/*	-	F1	F2
<b>RAL</b>							
P637 000	RAL-, Sikkens-, NCS	*	F1	F1/*	-	F1	F2

Shelves are only available in F2 **brushed**

**F2 (NEW)**

Knotty brushed

Front: 23 mm thick, at top and bottom 9 cm wide solid brushed rail, with integral fingerrip recess, sited inbetween on left and right 5.5 cm wide flattened rail, centre panel in wild brushed veneer.

CADRE	Front colour	Carcase	Vis. side	Panels	XW5/ XW6	Plinth	Shelving
P656 022	black	KS	F2	F2/*	-	F2	F2
P656 121	chestnut	*	F2	F2/*	-	F2	F2
P656 102	nature	*	F2	F2/*	-	F2	F2
<b>RAL</b>							
P666 000	RAL-, Sikkens-, NCS	*	F2	F2/*	-	F2	F2

**F3 (NEW)**

Striped brushed

Front: 23 mm thick, at top and bottom 9 cm wide solid plain brushed rail, with integral fingerrip recess, sited inbetween on left and right 5.5 cm wide flattened rail, centre panel in plain brushed veneer.

CADRE	Front colour	Carcase	Vis. side	Panels	XW5/ XW6	Plinth	Shelving
P616 022	black	KS	F3	F3/*	-	F3	F3
P616 121	chestnut	*	F3	F3/*	-	F3	F3
P616 102	nature	*	F3	F3/*	-	F3	F3
<b>RAL</b>							
P617 000	RAL-, Sikkens-, NCS	*	F3	F3/*	-	F3	F3

F1/\*, F2/\*, F3/\* side walls are available in grooved (OLWR) or smooth (OLW) version in a thickness of 19, 50, 75 and 100 mm.

**Note:**

- drawer panels (plain) are only available with TIP-ON, as an alternative we recommend pull-out panels with interior drawers.
- Pull-out panels 256 mm high are not available.
- A door width of 296 mm should not be exceeded, otherwise available in plain finish only.
- Ideally, fridges should be planned at a height of 78 cm in order to ensure easy opening of the door.



PREMIUM

**Glass doors**  
R Framed glass door,  
H Framed door, glass at top only



beachwood chalk chestnut



driftwood nature bianco



black olive shell

All RAL/Sikkens/NCS colours available.



Individual parts only available on request and at extra charge! No metallic colours available!

**F1 (previously TELAIO) Knotty raw**

Front: Solid sandblasted front in knotty oak, veneered centre panel, 9 cm wide frame.

TELAIO	Front colour	Carcase	Vis. side	Panels	XW5/ XW6	Plinth	Shelving
P634 019	beachwood	*	F1	F1/*	F1	F1	F2
P634 104	chalk	*	F1	F1/*	F1	F1	F2
P634 121	chestnut	*	F1	F1/*	F1	F1	F2
P634 031	driftwood	*	F1	F1/*	F1	F1	F2
P634 102	nature	*	F1	F1/*	F1	F1	F2

P634 006	bianco	KS	F1	F1/*	F1	F1	F2
P634 022	black	KS	F1	F1/*	F1	F1	F2
P634 032	olive	*	F1	F1/*	F1	F1	F2
P634 244	shell	KS	F1	F1/*	F1	F1	F2

RAL

P635 000	RAL-, Sikkens-, NCS	*	F1	F1/*	F1	F1	F2
----------	---------------------	---	----	------	----	----	----

Shelves are only available in F2 brushed

**F2 (NEW) Knotty brushed**

Front: Solid brushed front in knotty oak, veneered centre panel, 9 cm wide frame.

TELAIO	Front colour	Carcase	Vis. side	Panels	XW5/ XW6	Plinth	Shelving
P654 019	beachwood	*	F2	F2/*	F2	F2	F2
P654 104	chalk	*	F2	F2/*	F2	F2	F2
P654 121	chestnut	*	F2	F2/*	F2	F2	F2
P654 031	driftwood	*	F2	F2/*	F2	F2	F2
P654 102	nature	*	F2	F2/*	F2	F2	F2

P654 006	bianco	KS	F2	F2/*	F2	F2	F2
P654 022	black	KS	F2	F2/*	F2	F2	F2
P654 032	olive	*	F2	F2/*	F2	F2	F2
P654 244	shell	KS	F2	F2/*	F2	F2	F2

RAL

P655 000	RAL-, Sikkens-, NCS	*	F2	F2/*	F2	F2	F2
----------	---------------------	---	----	------	----	----	----

**F3 (NEW) Striped brushed**

Front: Solid plain brushed front in knotty oak, veneered centre panel, 9 cm wide frame.

TELAIO	Front colour	Carcase	Vis. side	Panels	XW5/ XW6	Plinth	Shelving
P614 019	beachwood	*	F3	F3/*	F3	F3	F3
P614 104	chalk	*	F3	F3/*	F3	F3	F3
P614 121	chestnut	*	F3	F3/*	F3	F3	F3
P614 031	driftwood	*	F3	F3/*	F3	F3	F3
P614 102	nature	*	F3	F3/*	F3	F3	F3

P614 006	bianco	KS	F3	F3/*	F3	F3	F3
P614 022	black	KS	F3	F3/*	F3	F3	F3
P614 032	olive	*	F3	F3/*	F3	F3	F3
P614 244	shell	KS	F3	F3/*	F3	F3	F3

RAL

P615 000	RAL-, Sikkens-, NCS	*	F3	F3/*	F3	F3	F3
----------	---------------------	---	----	------	----	----	----

Handle drilling options TELAIO F1, F2, F3

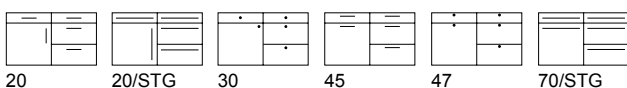

F1/\*, F2/\*, F3/\* side walls are available in grooved (OLWR) or smooth (OLW) version in a thickness of 19, 50, 75 and 100 mm.



**P  
R  
E  
M  
I  
U  
M**

**Glass doors**  
Only universal glass doors available



black chestnut nature  
All RAL/Sikkens/NCS colours available.



Individual parts only available on request and at extra charge!  
No metallic colours available!

**F1 (previously STRETTO) Knotty raw**

Front: 21 mm thick, at top and bottom 8 cm wide solid sandblasted rail, sited inbetween on left and right 1.2 cm wide rail, filling wild veneer, blasted.

STRETTO	Front colour	Carcase	Vis. side	Panels	XW5/ XW6	Plinth	Shelving
P638 022	black	KS	F1	F1/*	-	F1	F2
P638 121	chestnut	*	F1	F1/*	-	F1	F2
P638 102	nature	*	F1	F1/*	-	F1	F2
<b>RAL</b>							
P639 000	RAL-, Sikkens-, NCS	*	F1	F1/*	-	F1	F2

Shelves are only available in F2 **brushed**

**F2 (NEW) Knotty brushed**

Front: 21 mm thick, at top and bottom 8 cm wide solid brushed rail, sited inbetween on left and right 1.2 cm wide rail, filling wild veneer, brushed.

STRETTO	Front colour	Carcase	Vis. side	Panels	XW5/ XW6	Plinth	Shelving
P658 022	black	KS	F2	F2/*	-	F2	F2
P658 121	chestnut	*	F2	F2/*	-	F2	F2
P658 102	nature	*	F2	F2/*	-	F2	F2
<b>RAL</b>							
P659 000	RAL-, Sikkens-, NCS	*	F2	F2/*	-	F2	F2

**F3 (NEW) Striped brushed**

Front: 21 mm thick, at top and bottom 8 cm wide solid plain brushed rail, sited inbetween on left and right 1.2 cm wide rail, filling plain veneer, brushed.

STRETTO	Front colour	Carcase	Vis. side	Panels	XW5/ XW6	Plinth	Shelving
P618 022	black	KS	F3	F3/*	-	F3	F3
P618 121	chestnut	*	F3	F3/*	-	F3	F3
P618 102	nature	*	F3	F3/*	-	F3	F3
<b>RAL</b>							
P619 000	RAL-, Sikkens-, NCS	*	F3	F3/*	-	F3	F3

F1/\*, F2/\*, F3/\* side walls are available in grooved (OLWR) or smooth (OLW) version in a thickness of 19, 50, 75 and 100 mm.

Handle drilling options STRETTO F1, F2, F3

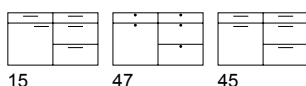

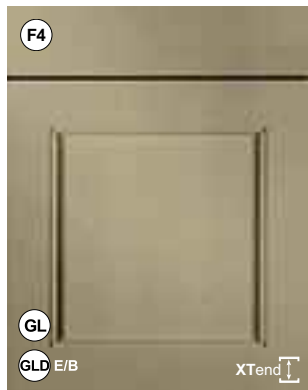

PREMIUM

Glass doors

H Framed door, glass at top only,  
R Framed glass door,  
K Crossbar door



bianco black olive

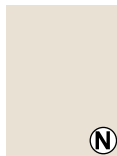

shell



All RAL/Sikkens/NCS colours available.

Individual parts only available on request and at extra charge! No metallic colours available!

Please place repeat orders for RAL fronts within 6 months in order to avoid a difference in colour.

F2 (NEW) Knotty brushed

Front: Pore matte oak with figure in coffered version, 7 cm solid frame, flat-cut veneer pore matte filling.

TOSCANA	Front colour	Carcase	Vis. side	Panels	XW5/ XW6	Pilasters	OZ 40/41 KL/LL	Plinth	Shelving
P650 006	bianco	KS	F2	F2/*	-	M	F2	F2	F2
P650 022	black	KS	F2	F2/*	-	M	F2	F2	F2
P650 032	olive	*	F2	F2/*	-	M	F2	F2	F2
P650 244	shell	KS	F2	F2/*	-	M	F2	F2	F2
<b>RAL</b>									
P651 000	RAL-, Sikkens-, NCS	*	F2	F2/*	-	M	F2	F2	F2

F3 (NEW) Striped brushed

Front: Pore matte plain oak in coffered version, 7 cm solid frame, flat-cut veneer plain pore matte filling.

TOSCANA	Front colour	Carcase	Vis. side	Panels	XW5/ XW6	Pilasters	OZ 40/41 KL/LL	Plinth	Shelving
P620 006	bianco	KS	F3	F3/*	-	M	F3	F3	F3
P620 022	black	KS	F3	F3/*	-	M	F3	F3	F3
P620 032	olive	*	F3	F3/*	-	M	F3	F3	F3
P620 244	shell	KS	F3	F3/*	-	M	F3	F3	F3
<b>RAL</b>									
P621 000	RAL-, Sikkens-, NCS	*	F3	F3/*	-	M	F3	F3	F3

F4 (previously TOSCANA, normal not PM) Silky smart

Front: Shaker-style oak front with semi-matt finish, 7 cm solid wood frame, flat veneered, lacquered centre panel.

TOSCANA	Front colour	Carcase	Vis. side	Panels	XW5/ XW6	Pilasters	OZ 40/41 KL/LL	Plinth	Shelving
P450 006	bianco	KS	F4	F4/*	-	M	F4	F4	F4
P450 022	black	KS	F4	F4/*	-	M	F4	F4	F4
P450 032	olive	*	F4	F4/*	-	M	F4	F4	F4
P450 244	shell	KS	F4	F4/*	-	M	F4	F4	F4
<b>RAL</b>									
P451 000	RAL-, Sikkens-, NCS	*	F4	F4/*	-	M	F4	F4	F4

Country-style elements available!

F2/\*, F3/\*, F4/\* side walls are available in grooved (OLWR) or smooth (OLW) version in a thickness of 19 mm.

Handle drilling options

TOSCANA F2, F3, F4

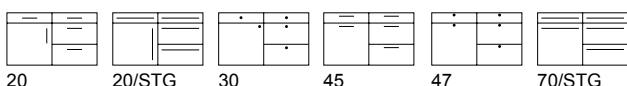

20

20/STG

30

45

47

70/STG

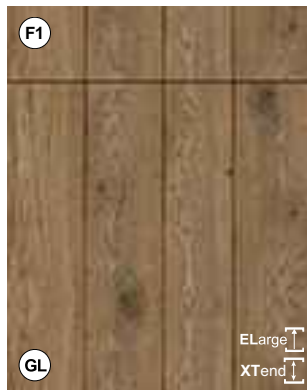

PREMIUM

ELarge  
XTend

Glass doors

L Door with vertical side stiles



F1 (previously ROUGH) Knotty raw

Front: Thick oak veneer sandblasted, without grooves (ZERO) or with grooves at 150 mm spacings (R15), vertical graining, reverse side in the same colour

ZERO	R15	Front colour	Carcase	Vis. side	Panels	XW5	Plinth	Shelving
P568 022	P569 022	black	KS	F1	F1/*	F1	F1	-
P568 017	P569 017	graphite	KS	F1	F1/*	F1	F1	-
P568 155	P569 155	pastell loam	*	F1	F1/*	F1	F1	-
P568 156	P569 156	pastell shadow	*	F1	F1/*	F1	F1	-
P568 157	P569 157	pastell smoke	*	F1	F1/*	F1	F1	-
P568 158	P569 158	plage	*	F1	F1/*	F1	F1	-

F1/\* side walls are available in grooved (OLWR) or smooth (OLW) version in a thickness of 19, 50, 75 and 100 mm.

Note for R15:

The following fronts have different groove spacings

40 + 80 cm = 132 mm

50 cm = 124 mm

100 cm = 142 mm

Handle drilling options

ROUGH ZERO F1

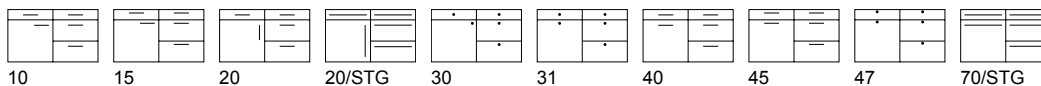

Handle drilling options

ROUGH R15 F1

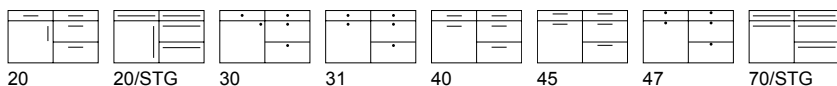



PREMIUM

**Glass doors**

G/GA/GM/R Framed glass door



chalk H/V



chestnut, H/V



real-nature, H/V

**F2 (previously REAL-OAK)**

Knotty brushed

Front: Industrial veneer, brushed and lacquered, on raw chipboard substrate, with horizontal/vertical graining, same-coloured edge all around.

REAL-OAK H	Front colour	Carcase	Vis. side	W19	XW5/ XW6	Plinth	Shelving
P359 104	chalk, H	*	F2	F2	F2	F2	F2
P359 121	chestnut, H	*	F2	F2	F2	F2	F2
P359 177	real-nature, H	*	F2	F2	F2	F2	F2

REAL-OAK V	Front colour	Carcase	Vis. side	W19	XW5/ XW6	Plinth	Shelving
P394 104	chalk, V	*	F2	F2	F2	F2	F2
P394 121	chestnut, V	*	F2	F2	F2	F2	F2
P394 177	real-nature, V	*	F2	F2	F2	F2	F2

W19: Side panels in industrial veneer are only available in a thickness of 19 mm and without grooves.

We would like to point out that in terms of the structure, colour and number of knots the appearance of the industrial veneer can vary and does not constitute grounds for complaint.

Handle drilling options

REAL-OAK H/V F2

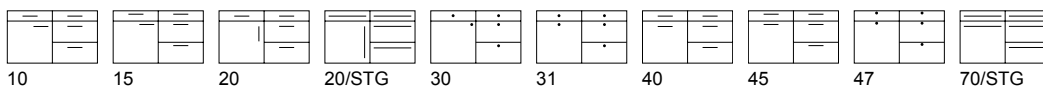

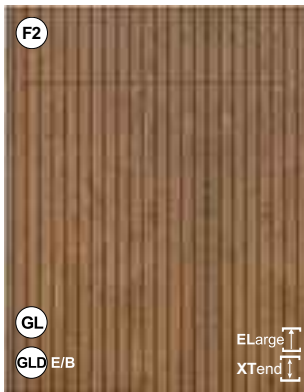

PREMIUM

**Glass doors**  
Only universal glass doors available

**F2** Knotty brushed

Front: Veneer oak/walnut front with knots and figure, brushed, on MDF base plate, with vertical lamella direction. 5 mm groove width between the lamellas. 21 mm thick front. Rear side same colour without lamellas.

VERTICO V	Front colour	Carcase	Vis. side	Panels	XW5/ XW6	Plinth	Shelving
P610 104	chalk	*	F2/*1	F2/*2	-	F2	F2
P610 121	chestnut	*	F2/*1	F2/*2	-	F2	F2
P610 031	driftwood	*	F2/*1	F2/*2	-	F2	F2
P610 102	nature	*	F2/*1	F2/*2	-	F2	F2
P610 216	walnut	*	F2/*1	F2/*2	-	F2	F2

P610 006	bianco	KS	F2/*1	F2/*2	-	F2	F2
P610 022	black	KS	F2/*1	F2/*2	-	F2	F2
P610 032	olive	*	F2/*1	F2/*2	-	F2	F2
P610 244	shell	KS	F2/*1	F2/*2	-	F2	F2

**RAL**

P611 000	RAL-, Sikkens-, NCS	*	F2/*1	F2/*2	-	F2	F2
----------	---------------------	---	-------	-------	---	----	----

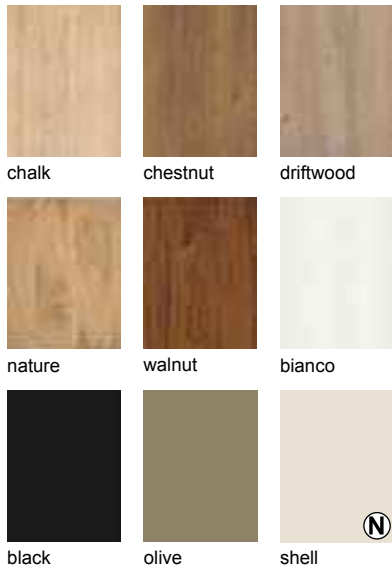

chalk chestnut driftwood

nature walnut bianco

black olive shell

**Note:**  
Visible sides F2/\*1 only available in smooth version.  
Side walls F2/\*2 available in 19 mm smooth (OLW) or 21 mm deep grooved on one side (OLWR)!  
Side walls 50-100 mm only available in smooth version (OLW).

 All RAL/Sikkens/NCS colours available.

Individual parts only available on request and at extra charge!  
No metallic colours available!

Only available handleless or with TIP-ON; drill holes are not possible.



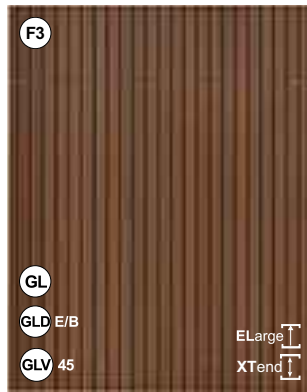

**P  
R  
E  
M  
I  
U  
M**

**Glass doors**  
Only universal glass doors available

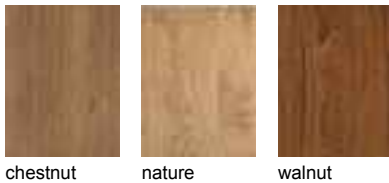

chestnut      nature      walnut

Only available handleless or with TIP-ON; handle drillings are not possible.

**F3** **Striped brushed**

**Front: Plain oak/walnut veneer front on black MDF; vertical grooves. Veneer rear side without grooves. The groove between the lamellas is 5 mm wide.**

BLACK STRIPE V	Front colour	Carcase	Vis. side	Panels	XW5/ XW6	Plinth	Shelving
<b>P622</b> 121	chestnut	*	F3/*1	F3/*2	-	F3	F3
<b>P622</b> 102	nature	*	F3/*1	F3/*2	-	F3	F3
<b>P622</b> 216	walnut	*	F3/*1	F3/*2	-	F3	F3

Please note:

**F3/\*1** side panels are always supplied with grooved surfaces, the front edge is unicoloured in wood tone, the rear side of the side panel is black.

**F3/\*2** 19mm side panels are supplied with grooves on one side (OLWR) or smooth (OLW). Front edge is unicoloured in wood tone. Side panels in other thicknesses (50, 75, 100 mm) are available only in smooth version (OLW, without grooves).

The black MDF is always visible on the handle profile for **GLV 45**.



**P  
R  
E  
M  
I  
U  
M**

**Glass doors**  
G/GA/GM/R Framed glass door



nature

Handle drilling options      BLACK-LINE F3 (only for handle 466/467/470)



45

**F3 (previously BLACK-LINE)** **Striped brushed**

**Front: Plain oak veneer on black MDF, horizontal grooving, reverse side oak veneer without grooving**

BLACK-LINE	Front colour	Carcase	Vis. side	Panels	XW5/ XW6	Plinth	Shelving
<b>P623</b> 102	nature	black	F3/*1	F3/*2	-	F3	F3

Note:

**F3/\*1** The face of visible sides is always supplied with grooving, the front edge is without grooving. The reverse side of the visible side is black.

**F3/\*2** Side panels 19 and 50 mm: available with grooving on one side and on the edge, side panels 75 and 100 mm are not available!

**Note:**

- With GLV45 and GLU the black MDF is always visible on the handle side
- On account of the horizontal grooving **GL780** and **S126 cannot be combined** (tall units with vertical GL-strip cannot be combined with handleless base units!)
- Doors outside of the modular grid are not predrilled at the factory

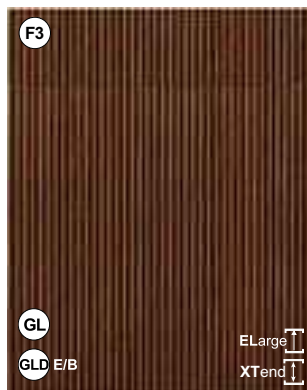

PREMIUM

**F3 (previously NOTCHO) Striped brushed**

Front: Vertically plain veneer grooved front (oak: black and nature, walnut) on raw chipboard/MDF substrate with 2 veneer thicknesses. Front thickness 20 mm, reverse side in the same colour but without grooves.

NOTCHO	Front colour	Carcase	Vis. side	Panels	XW5/ XW6	Plinth	Shelving
P624 022	black	KS	F3/*1	F3/*2	-	F3	F3
P624 102	nature	*	F3/*1	F3/*2	-	F3	F3
P624 216	walnut	*	F3/*1	F3/*2	-	F3	F3
RAL							
P625 000	RAL-, Sikkens-, NCS	*	F3/*1	F3/*2	-	F3	F3

**Glass doors**  
Only universal glass doors available



All RAL/Sikkens/NCS colours available.  
Individual parts only available on request and at extra charge!  
No metallic colours available!

Note:  
Visible side F3/\*1 only available without grooves  
Panels F3/\*2 19 mm only available with grooves on one side (OLWR) or without grooves on both sides (OLW)  
Panels 50-100 mm only available without grooves (OLW)

Only available handleless or with TIP-ON; drill holes are not possible.



PREMIUM

**F1 (previously ORBITA) Knotty raw**

Front: Solid, rustic finished and sandblasted door in knotty oak, 11 cm frame, veneered centre panel, reverse side in the same colour.

ORBITA	Front colour	Carcase	Vis. side	Panels	XW5/ XW6	Plinth	Shelving
P442 019	beachwood	*	F1	F1/*	-	F1	F2
P442 031	driftwood	*	F1	F1/*	-	F1	F2
P442 102	nature	*	F1	F1/*	-	F1	F2
RAL							
P443 000	RAL-, Sikkens-, NCS	*	F1	F1/*	-	F1	F2

Shelves are only available in F2 brushed

**Glass doors**  
R Framed glass door,  
H Framed door, glass at top only



All RAL/Sikkens/NCS colours available.  
Individual parts only available on request and at extra charge!  
No metallic colours available!

F1/\* side walls are available in grooved (OLWR) or smooth (OLW) version in a thickness of 19, 50, 75 and 100 mm.

Note:  
Doors less than 296 mm wide will be supplied without frame.

Please place repeat orders for RAL fronts within 6 months in order to avoid a difference in colour.

Handle drilling options

ORBITA F1

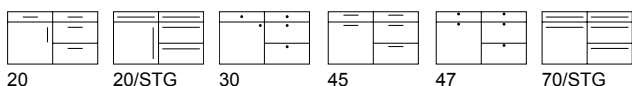



PREMIUM

**Glass doors**

R Framed glass door,  
H Framed door, glass at top only



beachwood    driftwood    nature



All RAL/Sikkens/NCS colours available.

Individual parts only available on request and at extra charge!  
No metallic colours available!

**F1 (previously RIPIENO) Knotty raw**

Front: Solid, rustic finished and sandblasted door in knotty oak, 11 cm frame, solid wood centre panel, reverse side in the same colour.

RIPIENO	Front colour	Carcase	Vis. side	Panels	XW5/ XW6	Plinth	Shelving
P541 019	beachwood	*	F1	F1/*	-	F1	F2
P541 031	driftwood	*	F1	F1/*	-	F1	F2
P541 102	nature	*	F1	F1/*	-	F1	F2
<b>RAL</b>							
P542 000	RAL-, Sikkens-, NCS	*	F1	F1/*	-	F1	F2

Shelves are only available in F2 brushed

F1/\* side walls are available in grooved (OLWR) or smooth (OLW) version in a thickness of 19, 50, 75 and 100 mm.

**Note:**

Doors less than 296 mm wide will be supplied without frame. Pull-out panels less than 352 mm high will be supplied with flat centre panel.

Handle drilling options

RIPIENO F1

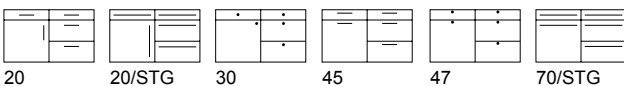

20    20/STG    30    45    47    70/STG



Handles,  
worktops decors,  
colour charts and  
discontinued lines

# Handles | Knobs

Handles/Knobs	No.	Details	Handles/Knobs	No.	Details
	200	chrome/matt, 160 mm  GRIBO: 10 - 15 - 20 - 40 - 45		385	black knurled, 160 mm overall length 188 mm ●  GRIBO: 10 - 15 - 20 - 40 - 45
	222	Slender stainless steel handle, 192 mm ●  GRIBO: 10 - 15 - 20 - 40 - 45		386	black, 160 mm overall length 181 mm  GRIBO: 10 - 15 - 20 - 40 - 45
	270	Matt brushed nickel, 128 mm ●  GRIBO: 10 - 15 - 20 - 40 - 45		392	Stainless steel, 160 mm  GRIBO: 10 - 15 - 20 - 40 - 45
	279	Zinc, 128 mm  GRIBO: 10 - 15 - 20 - 40 - 45		393	Matt black, 160 mm  GRIBO: 10 - 15 - 20 - 40 - 45
	285	Stainless steel coloured, 160 mm MP ●  GRIBO: 10 - 15 - 20 - 40 - 45		394	rose-gold, 160 mm  GRIBO: 10 - 15 - 20 - 40 - 45
	289	Anticato, 224 mm colour deviations are possible (restricted use on panels of 300 mm and less) MP for all price groups ● GRIBO: 10 - 15 - 20 - 40 - 45		396	Stone grey, 160 mm overall length 260 mm  GRIBO: 10 - 15 - 20 - 40 - 45
	297	Stainless steel coloured, 128 mm  GRIBO: 10 - 15 - 20 - 40 - 45		397	Stone grey, 320 mm overall length 419 mm only in combination with handle 396 used from a width of 600 mm MP GRIBO: 40 - 45
	298	Stainless steel finish, 192 mm overall length 230 mm  GRIBO: 10 - 15 - 20 - 40 - 45		413	Antiqued brown, 192 mm MP ●  GRIBO: 10 - 15 - 20 - 40 - 45
	299	Stainless steel look, 128 mm ●  GRIBO: 10 - 15 - 20 - 40 - 45		414	Antiqued brown, 288 mm only in combination with handle 413 MP ●  GRIBO: 40 - 45
	384	black, 160 mm overall length 206 mm  GRIBO: 10 - 15 - 20 - 40 - 45		421	Stainless steel look, 160 mm ●  GRIBO: 10 - 15 - 20 - 40 - 45

Melamine fronts

Matt-Line



High-gloss Line

Foil-wrapped fronts

Wood Range + Wood Specials

Handles, worktops decors, colour charts and discontinued lines

# Handles | Knobs

Handles/Knobs	No.	Details	Handles/Knobs	No.	Details
	422	Stainless steel look, 320 mm only in combination with handle 421 used from 600 mm width <b>MP</b> ● <b>GRIBO:</b> 40 - 45		461	Matt black, 192 mm overall length 200 mm <b>GRIBO:</b> 10 - 15 - 20 - 40 - 45
	423	brushed brass, 160 mm overall length 170 mm ● <b>GRIBO:</b> 10 - 15 - 20 - 40 - 45		506	short bar handle STGE Stainless steel, 184 mm fixed overall length 226 mm <b>MP</b> ● <b>GRIBO:</b> 10 - 15 - 20 - 40 - 45
	424	black, 160 mm overall length 200 mm <b>MP</b> <b>GRIBO:</b> 10 - 15 - 20 - 40 - 45		507	short bar handle STGEB powder-coated black, 184 mm fixed overall length 226 mm <b>MP</b> ● <b>GRIBO:</b> 10 - 15 - 20 - 40 - 45
	435	Matt black, 160 mm overall length 170 mm ● <b>GRIBO:</b> 10 - 15 - 20 - 40 - 45			
	436	Matt black lacquered, 192 mm overall length 199 mm <b>MP</b> <b>GRIBO:</b> 10 - 15 - 20 - 40 - 45		314	knob, black lacquered, 16 mm Vertical drilling is not possible! ● <b>GRIBO:</b> 40 - 45
	437	Matt black powder-coated, 128 mm overall length 164 mm <b>GRIBO:</b> 10 - 15 - 20 - 40 - 45		372	Knob anticato colour deviations are possible <b>MP</b> ● <b>GRIBO:</b> 30 - 47
	438	dark metal with weld seams, 160 mm overall length 175 mm <b>MP</b> for all price groups ● <b>GRIBO:</b> 10 - 15 - 20 - 40 - 45		373	Knob stainless steel ● <b>GRIBO:</b> 30 - 47
	439	dark metal with weld seams, 320 mm, overall length 335 mm only in combination with handle 438 used from a width of 600 mm <b>MP</b> for all price groups ● <b>GRIBO:</b> 40 - 45			
	452	Antiqued black, 160 mm <b>GRIBO:</b> 10 - 15 - 20 - 40 - 45			
	453	Stainless steel look, 192 mm ● <b>GRIBO:</b> 10 - 15 - 20 - 40 - 45			

# Handles | Knobs

Handles/Knobs	No.	Details
	<b>466</b>	Strip handle in brushed black <b>GRIBO: 10 - 15 - 20 - 40 - 45</b>
	<b>467*</b>	160 mm drilling distance overall length 225 mm / *375 mm, handle cut-out 130 mm centred the profile is a <b>fixed size</b> for all widths <b>MP ●</b> <b>GRIBO: 40 - 45</b> <small>as from 450 mm cabinet width</small>
	<b>470</b>	<b>Handle combination comprising:</b> 466 overall length 225 mm (for widths 300 + 400 mm) 467 overall length 375 mm (for widths 450 up to 500 mm) 468 overall length 525 mm (for widths 600 + 800 mm) 469 overall length 825 mm (for widths 900 - 1200 mm) used in <b>combination</b> <b>MP ●</b> <b>GRIBO: 40 - 45</b>

On Shaker-style or profiled doors only vertical (not horizontal) drilling is possible.







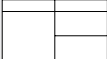

**MP** = Handles can be supplied at an extra charge in all price categories.

- = **Planning advice:** in corner solutions it is important to consider the 700 x 700 mm corner in order to guarantee flawless function.

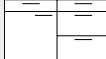
**BAR HANDLES ARE AVAILABLE ACROSS ALL PRICE GROUPS AT EXTRA CHARGE ONLY.**

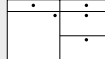
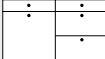
Bar handles	No.	Details
	<b>STGE</b>	stainless steel <b>MP ●</b> <b>GRIBO: 20/STG - 70/STG</b>
	<b>STGEB</b>	Powder-coated black <b>MP ●</b> <b>GRIBO: 20/STG - 70/STG</b>
 (N)	<b>STGBIG</b>	Black <b>MP ●</b> <b>GRIBO: 20/STG - 70/STG</b>

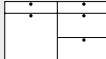
## GRIBO - Handle drilling options

						
<b>GRIBO 1</b> without drilling	<b>GRIBO 10</b> horizontal	<b>GRIBO 15</b> horizontal, high-set	<b>GRIBO 20</b> vertical	<b>GRIBO 20/STG</b> vertical bar handle	<b>GRIBO 30</b> knob drilling	<b>GRIBO 31</b> knob drilling centred
						
<b>GRIBO 40</b> centred Only available for flat fronts.	<b>GRIBO 45</b> centred, high-set	<b>GRIBO 47</b> knob drilling centred, high-set	<b>GRIBO 70/STG</b> hor. bar handle			



**08** COM strip down 995  
black



**09** COM strip rounded 996  
stainless steel



**10** COM strip square 997  
stainless steel



**11** COM strip square 994  
black



**WALL-strip 920**  
black

**Notes:**

- Extra charge per strip handle
  - Use base unit items from S126
  - Use wall unit items from GL780 (XH)
  - Use tall unit items from S126
- Upper doors/flaps on units housing appliances are always supplied with Tip-On  
For fridges a special strip handle is used  
Please note that only restricted versions for fridges are possible  
Due to the position of the strip handle, only split fridge/freezer combinations are possible

**The following items are not available:**

- Pull-out 256 mm high, seated at the bottom of a base/tall unit can only be supplied as a drawer
- UAG 45/60 26 and UGG 45/60 39 - pull-out to be opened from underneath
- U2AG 45/60 52 are not available
- UE 83/93 78/91 are not available
- For corner units USPV..., UV..., GV4L..., AGV2L... the precise planning size must be specified
- GEL..., GGEL..., GGEL2..., GKL... are not available





- |           |   |           |           |           |
|-----------|---|-----------|-----------|-----------|
| <b>01</b> | GL-E/B Handleless, stainless steel or black (flat door) | <b>NL</b> | <b>LL</b> | <b>PL</b> |
|-----------|---|-----------|-----------|-----------|
- |           |  |           |           |           |
|-----------|--|-----------|-----------|-----------|
| <b>02</b> | GLD-E/B Handleless decor (flat door), profile stainless steel or black | <b>NL</b> | <b>LL</b> | <b>PL</b> |
|-----------|--|-----------|-----------|-----------|
- |           |  |           |  |  |
|-----------|--|-----------|--|--|
| <b>03</b> | GLV-E/B Handleless (door with 45° chamfer + metal strip), stainless steel or black |           |  |  |
|           |  | <b>PL</b> |  |  |
- |           |  |           |  |  |
|-----------|--|-----------|--|--|
| <b>04</b> | GLX-E Handleless (door with 90° routing + stainless steel strip) |           |  |  |
|           |  | <b>PL</b> |  |  |
- |           |   |           |  |  |
|-----------|---|-----------|--|--|
| <b>05</b> | GLV-45 Handleless (door with 45° chamfer) |           |  |  |
|           |   | <b>PL</b> |  |  |
- |           |   |           |  |  |
|-----------|---|-----------|--|--|
| <b>06</b> | GLX-90 Handleless (door with 90° routing) |           |  |  |
|           |   | <b>PL</b> |  |  |
- |           |   |           |  |  |
|-----------|---|-----------|--|--|
| <b>07</b> | GLU Handleless (wooden door with U-routing) |           |  |  |
|           |   | <b>PL</b> |  |  |

# Worktop decors



1000 ALPINWEISS



1001 ANTHRAZIT SOLID COLOR



1002 ARKOSA SAND



1003 ARLINTON EICHE



1009 BETON ART PERLGRAU



1010 BETON DUNKEL



1011 BÉTON CLAIR



1012 BETON NATUR



1013 BLOCK BOARD NOCHE



1015 BORDOLINO EICHE GRAU



1017 CERAMIC ANTHRAZIT



1018 CERAMICO ROST

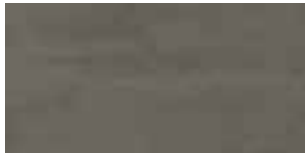

1019 ANTHRACITE CHROMIX

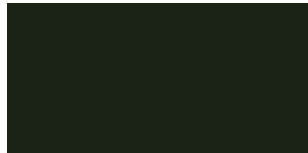

1025 DARK NIGHT



1031 CHÈNE SABLE SANREMO



1033 FLASH BLACK



1034 GLADSTONE OAK GREIGE



1036 GLITTERSTONE LIGHT



1037 GRAPHITGRAU, ORION



1039 HALIFAX EICHE WEISS



1041 ICY WHITE SOLID COLOR



1043 JURAMARMOR



1047 KUPFER



1049 LICHTGRAU



1053 METALLO GRAUBRAUN



1054 METALLSCHWARZ



1060 NATURAL LANCELOT OAK



1062 NEGRO BRASIL



1068 PALE LANCELOT OAK



1069 PAPYRUS NUBIA BRAUN



1072 RAJA BLACK



1077 SANDGRAU



1095 TIVOLI



1100 VICENZA EICHE HELL

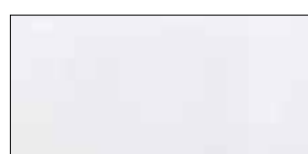

1104 WEISS STEINSTRUKTUR



1107 DOLPHIN

# Worktop decors



1108 SLATE



1109 HALIFAX EICHE NATUR



1110 CRUSH GOLD



1111 HALIFAX CRACK OAK



1150 CARBON

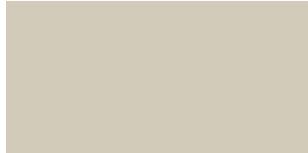

1160 PEBBLE GREY



1180 KITO BLAUSTAHL

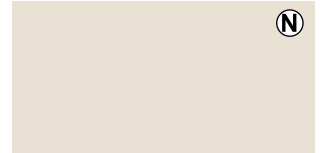

1181 SHELL



1182 WARMIA NUSSBAUM, WALNUT;



5001 FENIX BIANCO



5002 FENIX BIANCO ALASKA

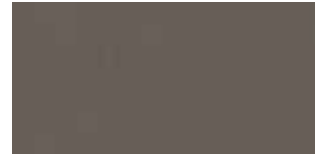

5003 FENIX GRIGIO LONDA



5004 FENIX NERO

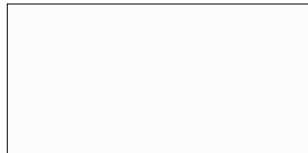

5005 FENIX BIANCO KOS



6000 EXTREM CARBON

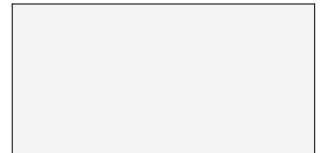

6001 EXTREM EDELWEISS



6002 EXTREM ICY WHITE



6003 EXTREM KASHMIRGRAU

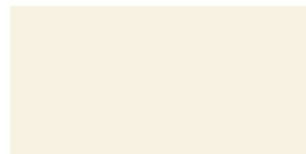

6008 EXTREM MAGNOLIENWEISS

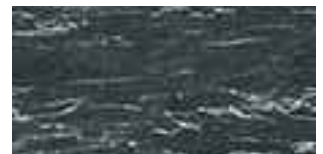

6009 EXTREM MARMOR SCHWARZ



6010 EXTREM MARMOR WEISS



6013 EXTREM SHARKY GREY



6014 EXTREM SNOW/KREIDE

Melamine  
fronts

Matt-Line

High-gloss Line

Foil-wrapped fronts

Wood Range + Wood Specials

Handles, worktops decors, colour charts and discontinued lines

## Worktop decors

Code No.	Decor	ID	40 mm 40/60/100 mm 16 + 40 mm			Same-coloured front colour	Same-coloured carcass	Max. length in mm	Same-coloured WAP
			RK	SK	PP				
1000	ALPINWEISS	1025	+	+	+	bianco	bianco	5000	+
1001	ANTHRAZIT SOLID COLOR	1290	-	+	+			4000	+
1002	ARKOSA SAND	276	+	+	+			5000	+
1003	ARLINTON EICHE	H3303	-	+	+	natural knotty oak	natural knotty oak	4000	+
1009	BETON ART PERLGRAU	44375	-	+	+	light oxide		4000	+
1010	BETON DUNKEL	275	+	+	+			5000	+
1011	BÉTON CLAIR	274	+	+	+			5000	+
1012	BETON NATUR	34149	-	+	+			4000	+
1013	BLOCK BOARD NOCHE	4206	+	+	+			5000	+
1015	BORDOLINO EICHE GRAU	1146	+	+	+	oak bardolino		5000	+
1017	CERAMIC ANTHRAZIT	311	+	+	+			5000	+
1018	CERAMICO ROST	6008	+	+	+			5000	+
1019	ANTHRACITE CHROMIX	641	+	+	+			5000	+
1025	DARK NIGHT	901	-	+	+	black	black	4000	+
1031	CHÉNE SABLE SANREMO	34139	-	+	+	sanremo oak		4000	+
1033	FLASH BLACK	7654	+	+	+			5000	+
1034	GLADSTONE OAK GREIGE	3326	+	+	+			5000	+
1036	GLITTERSTONE LIGHT	7655	+	+	+			5000	+
1037	GRAPHITGRAU	1257	-	+	+	orion	orion	5000	+
1039	HALIFAX EICHE WEISS	H1176	-		+	halifax white		4000	+
1041	ICY WHITE SOLID COLOR	1027	-	+	+	optiwhite	optiwhite	4000	+
1043	JURAMARMOR	6442	+	+	+			5000	+
1047	KUPFER	3236	+	+	+			5000	+
1049	LICHTGRAU	1188	+	+	+	grigio	grigio	5000	+
1053	METALLO GRAUBRAUN	633	+	+	+			5000	+
1054	METALLSCHWARZ	1233	+	+	+	graphite	graphite	5000	+
1060	NATURAL LANCELOT OAK	4263	+	+	+	sherwood nature		5000	+
1062	NEGRO BRASIL	6216	-	+	+			5000	+
1068	PALE LANCELOT OAK	4262	+	+	+			5000	+
1069	PAPYRUS NUBIA BRAUN	22008	+	+	+			5000	+
1072	RAJA BLACK	3505	+	+	+			5000	+
1077	SANDGRAU	1184	+	+	+			5000	+
1095	TIVOLI	6244	+	+	+			5000	+
1100	VICENZA EICHE HELL	H3157	-	+	+	vicenza oak claire		4000	+
1104	WEISS STEINSTRUKTUR	0179	-	+	+	optiwhite	optiwhite	5000	+
1107	DOLPHIN	U12044	-	+	+	dolphin	dolphin	5000	+
1108	SLATE	U12986	-	+	+	slate	slate	5000	+
1109	HALIFAX EICHE NATUR	H1180	-	+	+	halifax nature		5000	+
1110	CRUSH GOLD	F442	-	+	+	crush gold		5000	+
1111	HALIFAX CRACK OAK	H3183	-	+	+	halifax crack oak	halifax crack oak	5000	+
1150	CARBON	U201	-	+	+	carbon	carbon	5000	+
1160	PEBBLE GREY	U968	-	+	+	pebble-grey	pebble-grey	5000	+
1180	KITO BLAUSTAHL	FG76111	-	+	+	steel blue		5000	+
1181	SHELL	705	-	+	+	shell	shell	5000	+
1182	WARMIA NUSSBAUM	1307	-	+	+	walnut	walnut	5000	+

### FENIX-Decors

5001	FENIX BIANCO	29	-	+	FE	bianco	bianco	4000	+
5002	FENIX BIANCO ALASKA	30	-	+	FE	optiwhite	optiwhite	4000	+
5003	FENIX GRIGIO LONDA	718	-	+	FE	londra		4000	+
5004	FENIX NERO	720	-	+	FE	black	black	4000	+
5005	FENIX BIANCO KOS	0032	-	+	FE	kos white	bianco	4000	+

# Worktop decors

Code No.	Decor	ID	40 mm RK	40/60/100 mm SK	16 + 40 mm PP	Same-coloured front colour	Same-coloured carcass	Max. length in mm	Same-coloured WAP
<b>EXTREM-Decors</b>									
6000	EXTREM CARBON	U1233 XM	-	+	XM	graphite	graphite	4000	+
6001	EXTREM EDELWEISS	SR209 XM	-	+	XM			4000	+
6002	EXTREM ICY WHITE	U1027 XM	-	+	XM	optiwhite	optiwhite	4000	+
6003	EXTREM KASHMIRGRAU	U1168 XM	-	+	XM	cashmere	cashmere	4000	+
6008	EXTREM MAGNOLIENWEISS	U1379 XM	-	+	XM	magnolia	magnolia	4000	+
6009	EXTREM MARMOR SCHWARZ	S63028	-	+	XM			4000	+
6010	EXTREM MARMOR WEISS	S63009	-	+	XM			4000	+
6013	EXTREM SHARKY GREY	U091 XM	-	+	XM	sharky	sharky	4000	+
6014	EXTREM SNOW/KREIDE	U102 XM	-	+	XM	snow	snow	4000	+

FE Fenix HPL (special pricing, see price-list), PP PP-edge, RK radiused edge, SK HPL edge, WAP upstand, XM Extrem HPL (special pricing, see price-list)

## XM worktops

- Decorative high-pressure laminate with durable, electron-beam hardened surface and polished reverse side.
- Super-matt texture for the front and worktop with all the quality features and standard values for high-pressure laminate (HPL).
- Comfortably warm, velvety soft feel, inviting touch.
- Impervious to finger and grease marks, for visual appeal in everyday use.
- Optimum ease of cleaning for effortless removal of everyday soiling, above all stubborn grease stains.

## Important:

In order to enjoy your XTreme kitchen surfaces for as long as possible, we advise you to observe the following instructions:

- Fine, extra matt surfaces are delicate. The texture itself cannot prevent scratches
- Especially with darker decors mechanical stress can leave behind visible, unsightly marks

Signs of wear, caused for example by unglazed porcelain or cutting on the worktop, do not constitute grounds for complaint.

# Colour chart melamine

## PREMIUM LINE

KS melamine	Carcass	Vis. side	W 19	WR 19	W 50	W 100	Pilasters	XW5/ XW6	Plinth	Shelving	
arcai-red	(N) -	•	•	-	-	•	-	•	•	-	*OZ14/15 OZ36/37 OZ53/54
bianco	KS	-	•	•	-	•	K	-	•	•	K Pilaster, foil-wrapped
black	KS	-	•	-	-	-	-	-	•	•	
blackblue	(N) -	•	•	-	-	•	-	•	•	-	
blackgreen	(N) -	•	•	-	-	•	-	•	•	-	
carbon	KS	-	•	-	•	•	-	•	•	•	
dolphin	KS	-	•	-	•	•	-	•	•	•	
fango	-	•	•	-	•	•	-	•	•	•	
graphite	KS	-	•	-	-	-	-	-	•	•	
grigio	KS	-	•	-	•	•	-	•	•	•	
cashmere	KS	-	•	•	•	•	K	•	•	•	
pebble-grey	KS	-	•	-	•	•	-	•	•	•	
magnolia	KS	-	•	•	-	•	K	-	•	•	
moss	-	•	•	-	-	•	-	•	•	-	
muscata	-	•	•	-	•	•	-	•	•	•	
optiwhite	KS	-	•	-	•	•	-	•	•	•	
orion	(N) KS	-	•	-	•	•	-	•	•	•	
sharky	KS	-	•	-	•	•	-	•	•	•	
shell	(N) KS	-	•	-	•	•	-	•	•	•	
slate	KS	-	•	-	•	•	-	•	•	•	
snow	KS	-	•	-	-	-	-	-	•	•	
stormgrey	(N) -	•	•	-	-	•	-	•	•	-	

# Colour chart melamine

## LITE LINE

KS melamine	Carcase	Vis. side	W 19	WR 19	W 50	W 100	Pilasters	XW5/ XW6	Plinth	Shelving
arcai-red	(N) -	•	•	-	-	•	-	•	•	-
bianco	KS	-	•	-	-	-	-	-	•	•
blackblue	(N) -	•	•	-	-	•	-	•	•	-
blackgreen	(N) -	•	•	-	-	•	-	•	•	-
carbon	KS	-	•	-	•	•	-	•	•	•
dolphin	KS	-	•	-	•	•	-	•	•	•
fango	-	•	•	-	•	•	-	•	•	•
grigio	-	•	•	-	•	•	-	•	•	•
cashmere	-	•	•	-	•	•	-	•	•	•
pebble-grey	-	•	•	-	•	•	-	•	•	•
magnolia	-	-	•	-	-	-	-	-	•	•
moss	-	•	•	-	-	•	-	•	•	-
muscata	-	•	•	-	•	•	-	•	•	•
optiwhite	-	•	•	-	•	•	-	•	•	•
orion	(N) -	•	•	-	•	•	-	•	•	•
sharky	-	•	•	-	•	•	-	•	•	•
shell	(N) -	•	•	-	•	•	-	•	•	•
slate	KS	-	•	-	•	•	-	•	•	•
snow	-	-	•	-	-	-	-	-	•	•
stormgrey	(N) -	•	•	-	-	•	-	•	•	-

## NEW LINE

KS melamine	Carcase	Vis. side	W 19	WR 19	W 50	W 100	Pilasters	XW5/ XW6	Plinth	Shelving
arcai-red	(N) -	•	•	-	-	-	-	•	•	-
bianco	KS	-	•	-	-	-	-	-	•	•
blackblue	(N) -	•	•	-	-	-	-	•	•	-
blackgreen	(N) -	•	•	-	-	-	-	•	•	-
carbon	KS	-	•	-	-	-	-	•	•	•
delphin	KS	-	•	-	-	-	-	•	•	•
fango	-	•	•	-	-	-	-	•	•	•
grigio	-	•	•	-	-	-	-	•	•	•
cashmere	-	•	•	-	-	-	-	•	•	•
pebble-grey	-	•	•	-	-	-	-	•	•	•
magnolia	-	-	•	-	-	-	-	-	•	•
moss	-	•	•	-	-	-	-	•	•	-
muscata	-	•	•	-	-	-	-	•	•	•
optiwhite	-	•	•	-	-	-	-	•	•	•
orion	(N) -	•	•	-	-	-	-	•	•	•
sharky	-	•	•	-	-	-	-	•	•	•
shell	(N) -	•	•	-	-	-	-	•	•	•
slate	KS	-	•	-	-	-	-	•	•	•
snow	-	-	•	-	-	-	-	-	•	•
stormgrey	(N) -	•	•	-	-	-	-	•	•	-

## PREMIUM LINE

WL Woodline	Carcase	Vis. side	W 19	WR 19	W 50	W 100	Pilasters	XW5/ XW6	Plinth	Shelving
bianco	KS	•	•	-	•	•	-	•	•	•
black burned	(N) -	•	•	-	-	•	-	•	•	-
denver-oak	-	•	•	-	-	•	-	•	•	-
oak bardolino	-	•	•	-	•	•	-	•	•	•
natural knotty oak	KS	-	•	-	•	•	-	•	•	•
sanremo oak	-	•	•	-	•	•	-	•	•	•
vicenza oak claire	-	•	•	-	•	•	-	•	•	•

## LITE LINE

WL Woodline	Carcase	Vis. side	W 19	WR 19	W 50	W 100	Pilasters	XW5/ XW6	Plinth	Shelving
bianco	KS	•	•	-	•	•	-	•	•	•
black burned	(N) -	•	•	-	-	•	-	•	•	-
oak bardolino	-	•	•	-	•	•	-	•	•	•
denver-oak	-	•	•	-	-	•	-	•	•	-
natural knotty oak	-	•	•	-	•	•	-	•	•	•
sanremo oak	-	•	•	-	•	•	-	•	•	•
vicenza oak claire	-	•	•	-	•	•	-	•	•	•

# Colour chart melamine

## NEW LINE

WL Woodline	Carcase	Vis. side	W 19	WR 19	W 50	W 100	Pilasters	XW5/ XW6	Plinth	Shelving
bianco	KS	•	•	-	-	-	-	•	•	•
black burned (N)	-	•	•	-	-	-	-	•	•	-
denver-oak	-	•	•	-	-	-	-	•	•	-
oak bardolino	-	•	•	-	-	-	-	•	•	•
natural knotty oak	-	•	•	-	-	-	-	•	•	•
sanremo oak	-	•	•	-	-	-	-	•	•	•
vicenza oak claire	-	•	•	-	-	-	-	•	•	•

## PREMIUM LINE

ST Texture	Carcase	Vis. side	W 19	WR 19	W 50	W 100	Pilasters	XW5/ XW6	Plinth	Shelving
amber	-	•	•	-	-	•	-	•	•	•
argento	-	•	•	-	•	•	-	•	•	•
basalt dunkel	-	•	•	-	-	•	-	•	•	•
black (Albero) (N)	KS	•	•	-	-	•	-	•	•	•
black (Cemento)	KS	•	•	-	-	•	-	•	•	•
black (Feelwood) (N)	KS	•	•	-	-	•	-	•	•	•
black (Metal)	KS	•	•	-	-	•	-	•	•	•
bronze	-	•	•	-	-	•	-	•	•	•
brown (Metal)	-	•	•	-	-	•	-	•	•	•
coffee (N)	-	•	•	-	-	•	-	•	•	•
halifax crack oak	KS	-	•	-	•	•	-	•	•	•
halifax nature	-	•	•	-	•	•	-	•	•	•
halifax tin dark (N)	-	•	•	-	-	•	-	•	•	•
halifax white	-	•	•	-	•	•	-	•	•	•
knotty oak	-	•	•	-	•	•	-	•	•	•
light grey	-	•	•	-	-	•	-	•	•	•
nature (N)	-	•	•	-	-	•	-	•	•	•
noce (N)	-	•	•	-	-	•	-	•	•	•
light oxide	-	•	•	-	-	•	-	•	•	•
sherwood black	KS	•	•	-	-	•	-	•	•	•
sherwood burned wood	-	•	•	-	-	•	-	•	•	-
sherwood bushy park	-	•	•	-	-	•	-	•	•	•
sherwood cigar	-	•	•	-	-	•	-	•	•	•
sherwood engadina	-	•	•	-	-	•	-	•	•	•
sherwood graphite	KS	•	•	-	-	•	-	•	•	•
sherwood greenwich	-	•	•	-	-	•	-	•	•	•
sherwood nature	-	•	•	-	-	•	-	•	•	•
dark steel	-	•	•	-	-	•	-	•	•	•
steel blue	-	•	•	-	-	•	-	•	•	•
light umbra	-	•	•	-	-	•	-	•	•	•
walnut (N)	KS	-	•	-	•	•	-	•	•	•

# Colour chart melamine

## LITE LINE

ST Texture	Carcase	Vis. side	W 19	WR 19	W 50	W 100	Pilasters	XW5/ XW6	Plinth	Shelving
amber	-	•	•	-	-	•	-	•	•	•
argento	-	•	•	-	•	•	-	•	•	•
basalt dunkel	-	•	•	-	-	•	-	•	•	•
black (Albero) (N)	-	•	•	-	-	•	-	•	•	•
black (Cemento)	-	•	•	-	-	•	-	•	•	•
black (Feelwood)	-	•	•	-	-	•	-	•	•	•
black (Metal)	-	•	•	-	-	•	-	•	•	•
bronze	-	•	•	-	-	•	-	•	•	•
brown (Metal)	-	•	•	-	-	•	-	•	•	•
coffee (N)	-	•	•	-	-	•	-	•	•	•
halifax crack oak	-	•	•	-	•	•	-	•	•	•
halifax nature	-	•	•	-	•	•	-	•	•	•
halifax tin dark (N)	-	•	•	-	-	•	-	•	•	•
halifax white	-	•	•	-	•	•	-	•	•	•
knotty oak	-	•	•	-	•	•	-	•	•	•
light grey	-	•	•	-	-	•	-	•	•	•
nature (N)	-	•	•	-	-	•	-	•	•	•
noce (N)	-	•	•	-	-	•	-	•	•	•
light oxide	-	•	•	-	-	•	-	•	•	•
sherwood black	-	•	•	-	-	•	-	•	•	•
sherwood burned wood	-	•	•	-	-	•	-	•	•	-
sherwood bushy park	-	•	•	-	-	•	-	•	•	•
sherwood cigar	-	•	•	-	-	•	-	•	•	•
sherwood engadina	-	•	•	-	-	•	-	•	•	•
sherwood graphite	-	•	•	-	-	•	-	•	•	•
sherwood greenwich	-	•	•	-	-	•	-	•	•	•
sherwood nature	-	•	•	-	-	•	-	•	•	•
dark steel	-	•	•	-	-	•	-	•	•	•
steel blue	-	•	•	-	-	•	-	•	•	•
light umbra	-	•	•	-	-	•	-	•	•	•
walnut (N)	-	•	•	-	•	•	-	•	•	•

## NEW LINE

ST Texture	Carcase	Vis. side	W 19	WR 19	W 50	W 100	Pilasters	XW5/ XW6	Plinth	Shelving
amber	-	•	•	-	-	-	-	•	•	•
argento	-	•	•	-	-	-	-	•	•	•
basalt dunkel	-	•	•	-	-	-	-	•	•	•
black	-	•	•	-	-	-	-	•	•	•
bronze	-	•	•	-	-	-	-	•	•	•
halifax crack oak	-	•	•	-	-	-	-	•	•	•
halifax natur	-	•	•	-	-	-	-	•	•	•
halifax tin dark (N)	-	•	•	-	-	-	-	•	•	•
halifax white	-	•	•	-	-	-	-	•	•	•
knotty oak	-	•	•	-	-	-	-	•	•	•
light grey	-	•	•	-	-	-	-	•	•	•
light oxide	-	•	•	-	-	-	-	•	•	•
steelblue	-	•	•	-	-	-	-	•	•	•
walnut (N)	-	•	•	-	-	-	-	•	•	•

## PREMIUM LINE

ES Stainless steel	Carcase	Vis. side	W 19	WR 19	W 50	W 100	Pilasters	XW5/ XW6	Plinth	Shelving
stainless steel	-	-	-	-	-	-	-	-	•	-



# Colour chart Matt-Line

## PREMIUM LINE

UM Ultra matt	Carcase	Vis. side	W 19	WR 19	W 50	W 100	Pilasters	XW5/ XW6	Plinth	Shelving
bianco	KS	•	•	-	-	•	-	•	•	•
magnolia	KS	•	•	-	-	•	-	•	•	•
snow	KS	•	•	-	-	•	-	•	•	•

## LITE LINE

UM Ultra matt	Carcase	Vis. side	W 19	WR 19	W 50	W 100	Pilasters	XW5/ XW6	Plinth	Shelving
bianco	KS	•	•	-	-	•	-	•	•	•
magnolia	-	•	•	-	-	•	-	•	•	•
snow	-	•	•	-	-	•	-	•	•	•

## NEW LINE

UM Ultra matt	Carcase	Vis. side	W 19	WR 19	W 50	W 100	Pilasters	XW5/ XW6	Plinth	Shelving
bianco	KS	•	•	-	-	-	-	•	•	•
magnolia	-	•	•	-	-	-	-	•	•	•
snow	-	•	•	-	-	-	-	•	•	•

## PREMIUM LINE

SM HPL matt	Carcase	Vis. side	W 19	WR 19	W 50	W 100	Pilasters	XW5/ XW6	Plinth	Shelving
bianco	KS	•	•	-	•	•	-	•	•	•
kos white	KS	•	•	-	•	•	-	•	•	•
magnolia	KS	•	•	-	•	•	-	•	•	•
optiwhite	KS	•	•	-	•	•	-	•	•	•
shell	KS	•	•	-	•	•	-	•	•	•

## LITE LINE

SM HPL matt	Carcase	Vis. side	W 19	WR 19	W 50	W 100	Pilasters	XW5/ XW6	Plinth	Shelving
bianco	KS	•	•	-	•	•	-	•	•	•
magnolia	-	•	•	-	•	•	-	•	•	•
optiwhite	-	•	•	-	•	•	-	•	•	•
shell	-	•	•	-	•	•	-	•	•	•

## NEW LINE

SM HPL matt	Carcase	Vis. side	W 19	WR 19	W 50	W 100	Pilasters	XW5/ XW6	Plinth	Shelving
bianco	KS	•	•	-	-	-	-	•	•	•
magnolia	-	•	•	-	-	-	-	•	•	•
optiwhite	-	•	•	-	-	-	-	•	•	•
shell	-	•	•	-	-	-	-	•	•	•

## PREMIUM LINE

SMF Fenix	Carcase	Vis. side	W 19	WR 19	W 50	W 100	Pilasters	XW5/ XW6	Plinth	Shelving
bianco	KS	•	•	-	•	-	-	•	•	-
black	KS	•	•	-	•	-	-	•	•	-
bromo	-	•	•	-	•	-	-	•	•	-
cacao	-	•	•	-	•	-	-	•	•	-
lightgrey	-	•	•	-	•	-	-	•	•	-
kos white	KS	•	•	-	•	-	-	•	•	-
londra	-	•	•	-	•	-	-	•	•	-
midnight blue	-	•	•	-	•	-	-	•	•	-
optiwhite	KS	•	•	-	•	-	-	•	•	-
rosso	-	•	•	-	•	-	-	•	•	-
verde	-	•	•	-	•	-	-	•	•	-
cement white	-	SZ	SZ	-	SZ	SZ	-	•	SZ	-

SZ HPL soft cement

# Colour chart Matt-Line

## PREMIUM LINE

XTR Xtreme	Carcase	Vis. side	W 19	WR 19	W 50	W 100	Pilasters	XW5/ XW6	Plinth	Shelving
black	KS	•	•	-	•	•	-	•	•	-
graphite	KS	•	•	-	•	•	-	•	•	-
optiwhite	KS	•	•	-	•	•	-	•	•	-
orion	KS	•	•	-	•	•	-	•	•	-
shell	KS	•	•	-	•	•	-	•	•	-
snow	KS	•	•	-	•	•	-	•	•	-

## PREMIUM LINE

ACM - Acrylic matt	Carcase	Vis. side	W 19	WR 19	W 50	W 100	Pilasters	XW5/ XW6	Plinth	Shelving
aureo	KS kiesel	•	•	-	-	-	-	•	•	KS kiesel
bianco	KS	•	•	-	-	-	-	•	•	KS*
black	KS	•	•	-	-	-	-	•	•	KS*
graphite	KS	•	•	-	-	-	-	•	•	KS*
luminoso	•	•	•	-	-	-	-	•	•	-
opale	•	•	•	-	-	-	-	•	•	-
snow	KS	•	•	-	-	-	-	•	•	KS*
terricio	-	•	•	-	-	-	-	•	•	-
titanio	-	•	•	-	-	-	-	•	•	-

KS\* only unicolour, like carcasse  
Shelves are only available in  
plastic (KS)!

## PREMIUM LINE

ML Matt lacquered	Carcase	Vis. side	W 19	WR 19	W 50	W 100	Pilasters	XW5/ XW6	Plinth	Shelving
copper	-	•	•	-	-	-	-	-	•	-
copper crumble	-	•	•	-	-	-	-	-	•	-
gold	-	•	•	-	-	-	-	-	•	-
gold crumble	-	•	•	-	-	-	-	-	•	-
snow	KS	•	•	-	•	-	-	•	•	-
RAL/Sikkens/NCS colours	-	•	•	-	•	-	-	•	•	-

## LITE LINE

ML Matt lacquered	Carcase	Vis. side	W 19	WR 19	W 50	W 100	Pilasters	XW5/ XW6	Plinth	Shelving
snow	-	•	•	-	•	-	-	•	•	-

## PREMIUM LINE

MLMi Micron-textured lacquer	Carcase	Vis. side	W 19	WR 19	W 50	W 100	Pilasters	XW5/ XW6	Plinth	Shelving
bianco	KS	•	•	•	•	-	-	•	•	KS
black	KS	•	•	•	•	-	-	•	•	KS
carbon	KS	•	•	•	•	-	-	•	•	KS
graphite	KS	•	•	•	•	-	-	•	•	KS
cashmere	KS	•	•	•	•	-	-	•	•	KS
pebble-grey	KS	•	•	•	•	-	-	•	•	KS
londra	*	•	•	•	•	-	-	•	•	*
marone	*	•	•	•	•	-	-	•	•	*
midnight blue	*	•	•	•	•	-	-	•	•	*
moss	*	•	•	•	•	-	-	•	•	*
olive	*	•	•	•	•	-	-	•	•	*
orion	(N) KS	•	•	•	•	-	-	•	•	KS
seta	*	•	•	•	•	-	-	•	•	*
shell	(N) KS	•	•	•	•	-	-	•	•	KS
snow	(N) KS	•	•	•	•	-	-	•	•	KS
fir green	*	•	•	•	•	-	-	•	•	*
urbano	*	•	•	•	•	-	-	•	•	*
RAL/Sikkens/NCS colours	*	•	•	•	•	-	-	•	•	*

# Colour chart Matt-Line

## PREMIUM LINE

MLSO Matt lacquered/Soft	Carcase	Vis. side	W 19	WR 19	W 50	W 100	Pilasters	XW5/ XW6	Plinth	Shelving
bianco	KS	•	•	•	•	-	-	•	•	KS
black	KS	•	•	•	•	-	-	•	•	KS
carbon	KS	•	•	•	•	-	-	•	•	KS
graphite	KS	•	•	•	•	-	-	•	•	KS
cashmere	KS	•	•	•	•	-	-	•	•	KS
pebble-grey	KS	•	•	•	•	-	-	•	•	KS
londra	*	•	•	•	•	-	-	•	•	*
marone	*	•	•	•	•	-	-	•	•	*
midnight blue	*	•	•	•	•	-	-	•	•	*
moss	*	•	•	•	•	-	-	•	•	*
olive	*	•	•	•	•	-	-	•	•	*
orion	(N) KS	•	•	•	•	-	-	•	•	KS
seta	*	•	•	•	•	-	-	•	•	*
shell	(N) KS	•	•	•	•	-	-	•	•	KS
snow	(N) KS	•	•	•	•	-	-	•	•	KS
fir green	*	•	•	•	•	-	-	•	•	*
urbano	*	•	•	•	•	-	-	•	•	*

## PREMIUM LINE

UVM Matt lacquered	Carcase	Vis. side	W 19	WR 19	W 50	W 100	Pilasters	XW5/ XW6	Plinth	Shelving
aqua	-	•	•	-	-	-	-	•	•	-
bianco	KS	•	•	-	-	-	-	•	•	KS*
black	KS	•	•	-	-	-	-	•	•	KS*
carbon	KS	•	•	-	-	-	-	•	•	KS*
crush gold	-	•	•	-	-	-	-	•	•	-
dolphin	KS	•	•	-	-	-	-	•	•	KS*
fango	-	•	•	-	-	-	-	•	•	KS*
cashmere	KS	•	•	-	-	-	-	•	•	KS*
pebble-grey	KS	•	•	-	-	-	-	•	•	KS*
laguna	-	•	•	-	-	-	-	•	•	-
ocean	-	•	•	-	-	-	-	•	•	-
slate	KS	•	•	-	-	-	-	•	•	KS*
snow	KS	•	•	-	-	-	-	•	•	KS*
steel gold-brown	-	•	•	-	-	-	-	•	•	-

**KS\*** only unicolour, like carcasse Shelves are only available in plastic (KS)!

## LITE LINE

UVM Matt lacquered	Carcase	Vis. side	W 19	WR 19	W 50	W 100	Pilasters	XW5/ XW6	Plinth	Shelving
aqua	-	•	•	-	-	-	-	•	•	-
bianco	KS	•	•	-	-	-	-	•	•	KS*
black	-	•	•	-	-	-	-	•	•	KS*
carbon	KS	•	•	-	-	-	-	•	•	KS*
crush gold	-	•	•	-	-	-	-	•	•	-
dolphin	KS	•	•	-	-	-	-	•	•	KS*
fango	-	•	•	-	-	-	-	•	•	KS*
cashmere	-	•	•	-	-	-	-	•	•	KS*
pebble-grey	-	•	•	-	-	-	-	•	•	KS*
laguna	-	•	•	-	-	-	-	•	•	-
ocean	-	•	•	-	-	-	-	•	•	-
slate	KS	•	•	-	-	-	-	•	•	KS*
snow	-	•	•	-	-	-	-	•	•	KS*
steel gold-brown	-	•	•	-	-	-	-	•	•	-

**KS\*** only unicolour, like carcasse Shelves are only available in plastic (KS)!

# Colour chart High-gloss Line

## PREMIUM LINE

LM Lacquered metal look	Carcase	Vis. side	W 19	WR 19	W 50	W 100	Pilasters	XW5/ XW6	Plinth	Shelving
bronze dark	-	•	•	-	•	•	-	•	•	-
bronze light	-	•	•	-	•	•	-	•	•	-
silver	-	•	•	-	•	•	-	•	•	-
titanium	-	•	•	-	•	•	-	•	•	-

## PREMIUM LINE

BT Concrete	Carcase	Vis. side	W 19	WR 19	W 50	W 100	Pilasters	XW5/ XW6	Plinth	Shelving
clair-light	-	•	•	-	•	•	-	•	•	-
fonce-dark	-	•	•	-	•	•	-	•	•	-
moyen-medium	-	•	•	-	•	•	-	•	•	-
super-bright	-	•	•	-	•	•	-	•	•	-

## PREMIUM LINE

EG Fine gloss	Carcase	Vis. side	W 19	WR 19	W 50	W 100	Pilasters	XW5/ XW6	Plinth	Shelving
bianco	KS	•	•	-	•	•	-	•	•	•
cashmere	KS	•	•	-	•	•	-	•	•	•
optiwhite	KS	•	•	-	•	•	-	•	•	•

## LITE LINE

EG Fine gloss	Carcase	Vis. side	W 19	WR 19	W 50	W 100	Pilasters	XW5/ XW6	Plinth	Shelving
bianco	KS	•	•	-	•	•	-	•	•	•
cashmere	-	•	•	-	•	•	-	•	•	•
optiwhite	-	•	•	-	•	•	-	•	•	•

## NEW LINE

EG Fine gloss	Carcase	Vis. side	W 19	WR 19	W 50	W 100	Pilasters	XW5/ XW6	Plinth	Shelving
bianco	KS	•	•	-	-	-	-	•	•	•
cashmere	-	•	•	-	-	-	-	•	•	•
optiwhite	-	•	•	-	-	-	-	•	•	•

## PREMIUM LINE

SG HPL gloss	Carcase	Vis. side	W 19	WR 19	W 50	W 100	Pilasters	XW5/ XW6	Plinth	Shelving
bianco	KS	•	•	-	•	•	-	•	•	•
magnolia	KS	•	•	-	•	•	-	•	•	•
optiwhite	KS	•	•	-	•	•	-	•	•	•
snow	KS	•	•	-	•	•	-	•	•	•

## LITE LINE

SG HPL gloss	Carcase	Vis. side	W 19	WR 19	W 50	W 100	Pilasters	XW5/ XW6	Plinth	Shelving
bianco	KS	•	•	-	•	•	-	•	•	•
magnolia	-	•	•	-	•	•	-	•	•	•
optiwhite	-	•	•	-	•	•	-	•	•	•
snow	-	•	•	-	•	•	-	•	•	•

## NEW LINE

SG HPL gloss	Carcase	Vis. side	W 19	WR 19	W 50	W 100	Pilasters	XW5/ XW6	Plinth	Shelving
bianco	KS	•	•	-	-	-	-	•	•	•
magnolia	-	•	•	-	-	-	-	•	•	•
optiwhite	-	•	•	-	-	-	-	•	•	•
snow	-	•	•	-	-	-	-	•	•	•

# Colour chart High-gloss Line

## PREMIUM LINE

UVHG High-gloss laquered	Carcase	Vis. side	W 19	WR 19	W 50	W 100	Pilasters	XW5/ XW6	Plinth	Shelving
bianco	KS	•	•	-	-	-	-	•	-	SG
grigio	KS	•	•	-	-	-	-	•	•	-
cashmere	KS	•	•	-	-	-	-	•	-	EG
optiwhite	KS	•	•	-	-	-	-	•	-	SG
snow	KS	•	•	-	-	-	-	•	-	SG

## LITE LINE

UVHG High-gloss laquered	Carcase	Vis. side	W 19	WR 19	W 50	W 100	Pilasters	XW5/ XW6	Plinth	Shelving
bianco	KS	•	•	-	-	-	-	•	-	SG
grigio	-	•	•	-	-	-	-	•	•	-
cashmere	-	•	•	-	-	-	-	•	-	EG
optiwhite	-	•	•	-	-	-	-	•	-	SG
snow	-	•	•	-	-	-	-	•	-	SG

## NEW LINE

UVHG High-gloss laquered	Carcase	Vis. side	W 19	WR 19	W 50	W 100	Pilasters	XW5/ XW6	Plinth	Shelving
bianco	KS	•	•	-	-	-	-	•	-	SG
grigio	-	•	•	-	-	-	-	•	•	-
cashmere	-	•	•	-	-	-	-	•	-	EG
optiwhite	-	•	•	-	-	-	-	•	-	SG
snow	-	•	•	-	-	-	-	•	-	SG

## PREMIUM LINE

LG High-gloss lacquered	Carcase	Vis. side	W 19	WR 19	W 50	W 100	Pilasters	XW5/ XW6	Plinth	Shelving
bianco	KS	•	•	-	•	-	-	•	•	SG
snow	KS	•	•	-	•	-	-	•	•	SG
RAL/Sikkens/NCS colours	-	•	•	-	•	-	-	•	•	-

LG high-gloss lacquered models can also be combined with visible sides, panels, etc. in SG HPL gloss.

## LITE LINE

LG High-gloss lacquered	Carcase	Vis. side	W 19	WR 19	W 50	W 100	Pilasters	XW5/ XW6	Plinth	Shelving
bianco	KS	•	•	-	•	-	-	•	•	SG
snow	-	•	•	-	•	-	-	•	•	SG

LG high-gloss lacquered models can also be combined with visible sides, panels, etc. in SG HPL gloss.

## PREMIUM LINE

ACG - Acrylic glossy	Carcase	Vis. side	W 19	WR 19	W 50	W 100	Pilasters	XW5/ XW6	Plinth	Shelving
bianco	KS	•	•	-	-	-	-	•	•	-
black	KS	•	•	-	-	-	-	•	•	-
fumo	-	•	•	-	-	-	-	•	•	-
cashmere	KS	•	•	-	-	-	-	•	•	-
snow	KS	•	•	-	-	-	-	•	•	-

## PREMIUM LINE

F1 Knotty raw, Strong veneer, knotty with figure, blasted	Carcase	Vis. side	Panels	Panels + grooves	XW5/ XW6	Plinth	Shelving
beachwood	-	•	•	•	•	•	-
bianco	KS	•	•	•	•	•	-
black	KS	•	•	•	•	•	-
chalk	-	•	•	•	•	•	-
chestnut	-	•	•	•	•	•	-
driftwood	-	•	•	•	•	•	-
graphite	KS	•	•	•	XW5	•	-
nature	-	•	•	•	•	•	-
olive	-	•	•	•	•	•	-
pastell loam	-	•	•	•	XW5	•	-
pastell shadow	-	•	•	•	XW5	•	-
pastell smoke	-	•	•	•	XW5	•	-
plage	-	•	•	•	XW5	•	-
shell	KS	•	•	•	•	•	-
RAL/Sikkens/NCS colours	-	•	•	•	•	•	-

## Colour chart Wood Range + Wood Specials

F2 Knotty brushed, Knotty veneer with figure, brushed											M	Square pilasters
Carcase	Vis. side	Panels	Panels + grooves	XW5/XW6	KL/LL	Pilasters	Country Style	Plinth	Shelving			
beachwood	-	•	•	•	•	-	-	-	•	•		
bianco	KS	•	•	•	•	40/41	M	•	•	•		
black	KS	•	•	•	•	40/41	M	•	•	•		
chalk	-	•	•	•	•	-	-	-	•	•		
chestnut	-	•	•	•	•	-	-	-	•	•		
driftwood	-	•	•	•	•	-	-	-	•	•		
nature	-	•	•	•	•	-	-	-	•	•		
real-nature	-	•	•	-	•	-	-	-	•	•		
olive	-	•	•	•	•	40/41	M	•	•	•		
shell <sup>(N)</sup>	KS	•	•	•	•	40/41	M	•	•	•		
walnut	-	•	•	•	•	-	-	-	•	•		
RAL/Sikkens/NCS colours	-	•	•	•	•	40/41	M	•	•	•		

F3 Striped brushed, Plain Veneer without figure, brushed											M	Square pilasters
Carcase	Vis. side	Panels	Panels + grooves	XW5/XW6	KL/LL	Pilasters	Country Style	Plinth	Shelving			
beachwood	-	•	•	•	•	-	-	-	•	•		
bianco	KS	•	•	•	•	40/41	M	•	•	•		
black	KS	•	•	•	•	40/41	M	•	•	•		
chalk	-	•	•	•	•	-	-	-	•	•		
chestnut	-	•	•	•	•	-	-	-	•	•		
driftwood	-	•	•	•	•	-	-	-	•	•		
nature	-	•	•	•	•	-	-	-	•	•		
olive	-	•	•	•	•	40/41	M	•	•	•		
shell <sup>(N)</sup>	KS	•	•	•	•	40/41	M	•	•	•		
walnut	-	•	•	•	•	-	-	-	•	•		
RAL/Sikkens/NCS colours	-	•	•	•	•	40/41	M	•	•	•		

F4 Silky smart, Silky gloss finish											M	Square pilasters
Carcase	Vis. side	Panels	Panels + grooves	XW5/XW6	KL/LL	Pilasters	Country Style	Plinth	Shelving			
bianco	KS	•	•	•	-	40/41	M	•	•	•		
black	KS	•	•	•	-	40/41	M	•	•	•		
olive	-	•	•	•	-	40/41	M	•	•	•		
shell <sup>(N)</sup>	KS	•	•	•	-	40/41	M	•	•	•		
RAL/Sikkens/NCS colours	-	•	•	•	-	40/41	M	•	•	•		

## Conversion table

## Oak-Line Wood Range + Wood Specials

NOW					PREVIOUSLY	
Model name		Wood Range	Wood Specials	Identical	Oak-Line Model name	
MERINO H/V	F1	•		< >	LEGNO H/V	Please find more detailed information on page 55
SPLIT-PLANK OAK V	F1	•		< >	PLANK-OAK anticato	
TELAIO	F1	•		< >	TELAIO anticato	
CADRE	F1	•		< >	CADRE anticato	
ORBITA	F1		•	< >	ORBITA anticato	
STRETTO	F1	•		< >	STRETTO anticato	
RIPIENO	F1		•	< >	RIPIENO anticato	
ROUGH ZERO+R15	F1		•	< >	ROUGH ZERO+R15	
MERINO H/V	F2	•		< >	MERINO anticato	
SPLIT OAK H/V	F2	•		< >	SPLIT-OAK H/V	
LAMELLA	F2	•		< >	LAMELLA anticato	
REAL-OAK H/V	F2		•	< >	REAL-OAK H/V anticato	
BLACK-LINE	F3		•	< >	BLACK-LINE	
NOTCHO	F3		•	< >	NOTCHO	
TOSCANA	F4	•		< >	TOSCANA (normal, nicht PM)	

## Discontinued lines 2022

### PREMIUM LINE

Doors			
CASTLE graphite	CASTLE snow	CROSS reno	EDGE REAL-OAK complete
EDGE SHERWOOD complete	EDGE SINCRONO complete	ELEGANCE SOFT magnolia	EXTREM cashmere
EXTREM sharky	GROOVE graphite	GROOVE snow	INCAVO complete
INSPIRATION SOFT magnolia	INTENSE complete	LUNA MICRON blue grey	LUNA MICRON peach
LUNA MICRON rust	LUNA MICRON sharky	LUNA MICRON taupe	LUNA SOFT magnolia
MEDA graphite	MEDA snow	MERINO graphite	MERINO loam
METALLICO complete	MILA SOFT magnolia	MODERNO graphite	MODERNO snow
OPACO anthracite	PORTO wl graphite	PLANK-OAK loam	REAL-OAK H/V tiramisu
RIPIENO loam	RUPE ash	RUPE sand	SHERWOOD richmond
SINCRONO darkwood	SINCRONO nordic	SINCRONO stormy oak	STEP complete
STYLE Extrem optiwhite	STYLE Fenix optiwhite	STYLE Touch white	TELAIO graphite
TOSCANA graphite	TOSCANA magnolia		

Note:

The discontinued models listed are available up to the end of December 2022!

Carcase colours			
fango 014	vicenza oak claire 153		

## Discontinued lines 2022

### LITE LINE

Doors			
EDGE SHERWOOD complete	EDGE SINCRONO complete	OPACO anthracite	RUPE ash
RUPE sand	SINCRONO stormy oak		

Note:

The discontinued models listed are available up to the end of December 2022!

## Discontinued lines 2022

### NEW LINE

Doors			
PORTO wl graphite	SINCRONO nordic		

Note:

The discontinued models listed are available up to the end of December 2022!

## Discontinued lines 2022

### LITE LINE

### PREMIUM LINE

### NEW LINE

Handles			
226	313	425	440
441			

Worktops decors			
1020 CODY WEISS	1032 ESCHE MOLINA SAND	1046 KRISTALLWEISS SOLID COLOR	5000 FENIX ACCIAIO HAMILTON

**Schröder Küchen GmbH & Co. KG**

Oepings Brink 7 – D-32278 Kirchlengern  
Fon +49 (0) 52 23 / 97 35-0 – Fax +49 (0) 52 23 / 97 35-35/-341  
info@schroeder-kuechen.de – www.schroeder-kuechen.de