



à la
carte
2023

Premium
Lite Line
New Line

Contenido

Carcasa.....	2
Costados vistos.....	3 - 5
Altura de carcasa y puerta.....	6 - 12
Vitrinas.....	13
Blum LEGRABOX / TANDEMBOX-ANTARO.....	14 - 15
Blum TANDEMBOX-PLUS.....	16
Acabados en melamina	
TOUCH / TOUCH com.....	18 - 19
PORTO H/V w/ / PORTO H/V w/ com.....	20
ALBERO H/V / ALBERO H/V com.....	21
SINCRONO H/V / SINCRONO H/V com.....	22 - 23
SHERWOOD H/V / SHERWOOD H/V com.....	24
SMART H/V / SMART H/V com.....	25
CEMENTO / CEMENTO com.....	26
METALL H/V / METALL H/V com.....	27
STYLE.....	28
Acabados mates	
FEELWOOD H/V / FEELWOOD H/V com.....	30
FROST / FROST com.....	31
OPACO / OPACO com.....	32
EXTREM / EXTREM com, URBAN / URBAN com.....	33
POMP.....	34
FENIX / FENIX com, ART-GLAS MATT.....	35
EFFECTO / EFFECTO com, CONCRETE.....	36
LUNA R2 / LUNA R2 com.....	37
LUNA R2 RAL / LUNA R2 RAL com.....	37
LUNA MICRON / LUNA MICRON com.....	38
LUNA SOFT / LUNA SOFT com.....	39
INSPIRATION SOFT.....	40
ELEGANCE SOFT.....	41
MILA SOFT.....	42
Acabados brillantes	
SILK / SILK com.....	44
ESPRIT / ESPRIT com.....	45
LUCE / LUCE com.....	46
LUCE INFINITY / LUCE INFINITY com.....	47
PASSION / PASSION com.....	48
PASSION R2 RAL.....	48
LUCIDA / LUCIDA com.....	49
ART-GLAS GLOSS.....	50
Acabados polilaminados	
GROOVE matt.....	52
CASTLE matt, MEDA matt.....	53
MODERNO matt.....	54
Wood Range + Wood Specials	
WOOD RANGE + SPECIALS Sumario.....	56 - 57
MERINO H/V.....	58 - 59
SPLIT PLANK-OAK V, SPLIT OAK H/V.....	60
LAMELLA.....	61
CADRE.....	62
TELAIO.....	63
STRETTO.....	64
TOSCANA.....	65
ROUGH zero + R15.....	66
REAL-OAK H/V.....	67
VERTICO V.....	68
BLACK STRIPE V, BLACK-LINE.....	69
NOTCHO, ORBITA.....	70
RIPIENO.....	71
Tiradores, encimeras, tablas de acabados, Tabla de conversión, modelos descatalogados	
Tiradores.....	73 - 77
Encimeras.....	78 - 81
Tablas de acabados.....	81 - 90
Tabla de conversión.....	90
Modelos descatalogados 2022.....	91

Leyenda

N	NUEVO
GL	Sin tirador
GLD E/B	Sin tirador, acabado de puerta más perfil metálico o metálico negro
GLV E/B	Sin tirador, puerta recortada a 45° con perfil metálico o metálico negro a 45°
GLX E	Sin tirador (puerta mecanizada a 90° con perfil metálico a 90°)
GLV 45	Sin tirador (puerta recortada a 45° y finalizada)
GLX 90	Sin tirador (puerta recortada a 90° y finalizada)
GLU	Sin tirador (puerta con fresado en forma de U)

ELarge Extra Large, puertas verticales de una sola pieza hasta 195 cm en acabados de **madera** o imitaciones y 234 cm en acabados **lisos**

EWide Extra Wide, frentes horizontales de cajones o de puertas abatibles hasta 180 cm de ancho

XTend Puertas superiores de columnas sin frente fijo, de una sola pieza

COM Modelos disponibles con tirador COM 996 redondeado, 994 + 997 cuadrado o 995 negro (No es posible solicitar muebles de anchuras especiales)

CLA En los modelos COM, algunas columnas de electrodomésticos tienen una distribución de frentes diferente (Ver lista de precios)

Carcasa

KS	Color de carcasa de melamina lisa en interior y exterior
*	Color de carcasa a elección, sin posibilidad de color de frente igual

Costados vistos

Especificar en el pedido si se desean costados vistos!
(Los acabados de madera siempre tienen la veta en sentido vertical)









-	No es necesario
KS	Melamina
WL	Woodline
ST	Estructurado imitando madero
UM	Ultra mate
SM	Estratificado mate
SMF	Estratificado mate Fenix
XTR	Estratificado mate Extrem
SZ	Estratificado acabado cemento
UVM	UV-lacado mate
ACM	Acrílico mate
ML	Lacado mate
MLMI	Lacado mate Micron
MLSO	Lacado mate Soft
BT	Superficie Béton
LM	Lacado / Metálico
EG	Melamina brillante
SG	Estratificado brillante
ACG	Acrílico brillante
UVHG	UV-lacado brillante
LG	Lacado brillante
F1	knotty raw (Rechapado grueso nudoso, arenado y cepillado)
F2	knotty brushed (Rechapado nudoso, cepillado profundo)
F3	striped brushed (Rechapado fino poco nudoso, cepillado superficial)
F4	silky smart (Satinado, lacado)

Costados decorativos

-	No disponible
KS	Melamina*
WL	Woodline
ST	Estructurado imitando madera
UM	Ultra mate
SM	Estratificado mate
SMF	Estratificado mate Fenix*
XTR	Estratificado mate Extrem*
SZ	Estratificado acabado cemento
UVM	UV- Lacado mate
ACM	Acrílico mate
ML	Lacado mate
MLMI	Lacado mate Micron
MLSO	Lacado mate Soft
BT	Superficie Béton
LM	Lacado / Metálico
EG	Melamina brillante
SG	Estratificado brillante
ACG	Acrílico brillante

UVHG	UV-Lacado brillante
LG	Lacado brillante
F1	knotty raw (Rechapado grueso nudoso, arenado y cepillado)
F2	knotty brushed (Rechapado nudoso, cepillado profundo)
F3	striped brushed (Rechapado fino poco nudoso, cepillado superficial)
F4	silky smart (Satinado, lacado)

Cornisas / Tapaluces

OZ 14	 Tapaluze polilaminado o lacado mate
OZ 15	 Cornisa polilaminado o lacado mate
OZ 36	 Tapaluze polilaminado o lacado mate
OZ 37	 Cornisa polilaminado o lacado mate
OZ 40	 Tapaluze, rechapado/lacado (F4)
OZ 41	 Cornisa, rechapado/lacado (F4)
OZ 53	 Cornisa polilaminado o lacado mate
OZ 54	 Tapaluze polilaminado o lacado mate

Pilastra

K	Pilastra polilaminado
M	Pilastra madera lacada, cuadrada

Zócalos

Especificar en el pedido el acabado del zócalo!
(Los acabados de madera siempre tienen la veta en sentido vertical)

-	No disponible
KS	Melamina
WL	Woodline horizontal (max. 260 cm)
ST	Estruct. madera imitando horizontal (max. 260 cm)
UM	Ultra mate (max. 260 cm)
SM	Estratificado mate
SMF	Estratificado mate Fenix
XTR	Estratificado mate Extrem
SZ	Estratificado acabado cemento
UVM	UV-Lacado mate
ACM	Acrílico mate
ML	Lacado mate
MLMI	Lacado mate Micron
MLSO	Lacado mate Soft
BT	Superficie Béton (max. 250 cm)
LM	Lacado / Metálico
EG	Melamina brillante (max. 260 cm)
SG	Estratificado brillante
ACG	Acrílico brillante
UVHG	UV-Lacado brillante
LG	Lacado brillante
F1	knotty raw (Rechapado grueso nudoso, arenado y cepillado)
F2	knotty brushed (Rechapado nudoso, cepillado profundo)
F3	striped brushed (Rechapado fino poco nudoso, cepillado superficial)
F4	silky smart (Satinado, lacado)

Estantes

Especificar en el pedido el acabado del estante!
(Los acabados de madera siempre tienen la veta en sentido vertical)

-	No disponible
KS	Melamina*
WL	Woodline
ST	Estructurado imitando madera
UM	Ultra mate
SM	Estratificado mate
EG	Melamina brillante
SG	Estratificado brillante
F2	knotty brushed (Rechapado nudoso, cepillado profundo)
F3	striped brushed (Rechapado fino poco nudoso, cepillado superficial)
F4	silky smart (Satinado, lacado)

* STY = Acabado también disponible con canto Style STY!
Ver página 28

Colores de carcasa

PREMIUM LINE

La carcasa tiene **de serie** el mismo acabado interior y exterior e incluye cantos de PP



bianco 006



negro 008



carbón 063



delfín 123



grafito 017



grigio 095



halifax crack oak 199



cachemir 024



grava 064



magnolia 090



roble natural 028



optiwhite 007



orion 243



sharky 126



shell 244

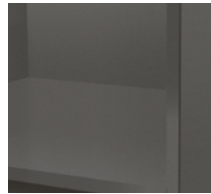

pizarra 128



snow 101



nogal 216

Todos los acabados de madera tienen superficie texturizada (WL/ST)



Colores de carcasa

LITE LINE

La carcasa tiene **de serie** el mismo acabado interior y exterior e incluye cantos de PP



bianco 006



carbón 063



delfín 123



pizarra 128



Colores de carcasa

NEW LINE

La carcasa tiene **de serie** el mismo acabado interior y exterior e incluye cantos de PP



bianco 006



carbón 063



delfín 123



pizarra 128



En carcacas con costado visto el canto frontal es en el acabado del costado seleccionado. El resto de cantos tienen el mismo acabado que la carcasa seleccionada. Debido a la diferencia de materiales y texturas, se puede llegar a apreciar cierta diferencia entre el acabado del costado visto y el del frente del mueble

COSTADOS VISTOS GRATUITOS

COSTADO VISTO:	CARCASA:	COSTADO VISTO:	CARCASA:	COSTADO VISTO:	CARCASA:
KS polilaminado		WL Woodline		EG Melamina brillante	
arcai-red	(N) a elección	bianco	bianco	bianco	bianco
blackblue	(N) a elección	black burned	(N) a elección	cachemir	cachemir
blackgreen	(N) a elección	roble denver	a elección	optiwhite	optiwhite
fango	a elección	roble bardolino	a elección	UM Ultra mate	
musgo	a elección	roble sanremo	a elección	bianco	bianco
muscata	a elección	vicenza oak claire	a elección	magnolia	magnolia
stormgrey	(N) a elección			snow	snow

COSTADOS VISTOS CON SUPLEMENTO

ST Estructurado imitando madera	SMF Estratificado mate FENIX	MLMi - Lacado mate Micron
amber	azul noche	verde abeto
argento	optiwhite	urbano
basalt oscuro	rosso	Colores RAL, Sikkens, NCS
negro (Albero)	verde	MLSO - Lacado mate Soft
negro (Cemento)	SZ Estratificado acabado cemento	bianco
negro (Feelwood)	cemento blanco	negro
negro (Metall)	BT Superficie Béton	carbón
bronce	claro	grafito
marrón (Metall)	oscuro	cachemir
café	medio	grava
natural Halifax	superclaro	londra
halifax tin dark	Lacado mate UVM	marone
blanco Halifax	aqua	azul noche
roble nudoso	bianco	musgo
gris claro	black	oliva
nature	carbón	orion
noce	acabado dorado	seta
oxyde claro	delfín	shell
sherwood negro	fango	snow
sherwood burned wood	cachemir	verde abeto
sherwood bushy park	grava	urbano
sherwood cigar	laguna	LM Lacado metálico
sherwood engadina	océano	bronce oscuro
sherwood grafito	Pizarra	bronce claro
sherwood greenwich	snow	silver
sherwood natural	acero dorado-marrón	titan
acero oscuro	ML - Lacado mate	ACM - Acrílico mate
acero azul	cobre	aureo
umbra claro	cobre cepillado	bianco
XTR Estratificado mate extreme	oro	negro
negro	oro cepillado	grafito
grafito	snow	luminoso
optiwhite	Colores RAL, Sikkens, NCS	opale
orion	MLMi - Lacado mate Micron	snow
shell	bianco	terricio
snow	negro	titanio
SM Estratificado mate	carbón	SG Estratificado brillante
bianco	grafito	bianco
magnolia	cachemir	magnolia
optiwhite	grava	optiwhite
shell	londra	snow
SMF Estratificado mate FENIX	marone	LG Lacado brillante
bianco	azul noche	bianco
negro	musgo	snow
bromo	oliva	Colores RAL, Sikkens, NCS
cacao	orion	UVHG Lacado brillante
gris claro	seta	bianco
blanco kos	shell	grigio
londra	snow	

Costados vistos

PREMIUM LINE

En carcassas con costado visto el canto frontal es en el acabado del costado seleccionado. El resto de cantos tienen el mismo acabado que la carcassa seleccionada. Debido a la diferencia de materiales y texturas, se puede llegar a apreciar cierta diferencia entre el acabado del costado visto y el del frente del mueble

COSTADOS VISTOS CON SUPLEMENTO

COSTADO VISTO:	CARCASA:	COSTADO VISTO:	CARCASA:	COSTADO VISTO:	CARCASA:
UVHG Lacado brillante		F1 Knotty raw		F3 Striped brushed	
cachemir	cachemir	oliva	a elección	beachwood	a elección
optiwhite	optiwhite	pastell loam	a elección	bianco	bianco
snow	snow	pastell shadow	a elección	negro	negro
ACG - Acrílico brillante		pastell smoke	a elección	tiza	a elección
bianco	bianco	playa	a elección	castaño	a elección
negro	negro	shell	(N) shell	driftwood	a elección
fumo	a elección	F2 Knotty brushed		nature	a elección
cachemir	cachemir	beachwood	a elección	oliva	a elección
snow	snow	bianco	bianco	shell	(N) shell
F1 Knotty raw		negro	negro	nogal	a elección
beachwood	a elección	tiza	a elección	F4 Silky smart	
bianco	bianco	castaño	a elección	bianco	bianco
negro	negro	driftwood	a elección	negro	negro
tiza	a elección	nature	a elección	oliva	a elección
castaño	a elección	oliva	a elección	shell	(N) shell
driftwood	a elección	real-nature	a elección		
grafito	grafito	shell	(N) shell		
nature	a elección	nogal	a elección		

Costados vistos

LITE LINE

En carcassas con costado visto el canto frontal es en el acabado del costado seleccionado. El resto de cantos tienen el mismo acabado que la carcassa seleccionada. Debido a la diferencia de materiales y texturas, se puede llegar a apreciar cierta diferencia entre el acabado del costado visto y el del frente del mueble

COSTADOS VISTOS GRATUITOS

COSTADO VISTO:	CARCASA:	COSTADO VISTO:	CARCASA:	COSTADO VISTO:	CARCASA:
KS polilaminado		KS polilaminado		UM Ultra mate	
arcai-red	(N) a elección	sharky	a elección	bianco	bianco
blackblue	(N) a elección	shell	(N) a elección	magnolia	a elección
blackgreen	(N) a elección	snow	a elección	snow	a elección
fango	a elección	stormgrey	(N) a elección	EG Melamina brillante	
grigio	a elección	WL Woodline		bianco	bianco
cachemir	a elección	bianco	bianco	cachemir	a elección
grava	a elección	black burned	(N) a elección	optiwhite	a elección
magnolia	a elección	roble denver	a elección		
musgo	a elección	roble bardolino	a elección		
muscata	a elección	roble natural	a elección		
optiwhite	a elección	roble sanremo	a elección		
orion	(N) a elección	vicenza oak claire	a elección		

COSTADOS VISTOS CON SUPLEMENTO

ST Estructurado imitando madera	ST Estructurado imitando madera	Lacado mate UVM
amber	sherwood burned wood	aqua
argento	sherwood bushy park	bianco
basalt oscuro	sherwood cigar	negro
negro (Albero)	sherwood engadina	carbón
negro (Cemento)	sherwood grafito	acabado dorado
negro (Metall)	sherwood greenwich	delfín
marrón (Metall)	sherwood natural	fango
café	acero oscuro	cachemir
halifax crack oak	acero azul	grava
natural Halifax	umbra claro	laguna
halifax tin dark	nogal	océano
bianco Halifax	(N) a elección	Pizarra
roble nudoso	SM Estratificado mate	snow
gris claro	bianco	acero dorado-marrón
nature	magnolia	ML - Lacado mate
noce	optiwhite	snow
oxyde claro	shell	a elección
sherwood negro	(N) a elección	

Costados vistos

LITE LINE

En carcasa con costado visto el canto frontal es en el acabado del costado seleccionado. El resto de cantos tienen el mismo acabado que la carcasa seleccionada. Debido a la diferencia de materiales y texturas, se puede llegar a apreciar cierta diferencia entre el acabado del costado visto y el del frente del mueble

COSTADOS VISTOS CON SUPLEMENTO

COSTADO VISTO:	CARCASA:	COSTADO VISTO:	CARCASA:	COSTADO VISTO:	CARCASA:
SG Estratificado brillante		UVHG Lacado brillante		LG Lacado brillante	
bianco	bianco	bianco	bianco	bianco	bianco
magnolia	a elección	grigio	a elección	snow	a elección
optiwhite	a elección	cachemir	a elección		
snow	a elección	optiwhite	a elección		
		snow	a elección		

Costados vistos

NEW LINE

En carcasa con costado visto el canto frontal es en el acabado del costado seleccionado. El resto de cantos tienen el mismo acabado que la carcasa seleccionada. Debido a la diferencia de materiales y texturas, se puede llegar a apreciar cierta diferencia entre el acabado del costado visto y el del frente del mueble

COSTADOS VISTOS GRATUITOS

COSTADO VISTO:	CARCASA:	COSTADO VISTO:	CARCASA:	COSTADO VISTO:	CARCASA:
KS polilaminado		WL Woodline		UM Ultra mate	
arcai-red	Ⓝ a elección	bianco	bianco	bianco	bianco
blackblue	Ⓝ a elección	black burned	Ⓝ a elección	magnolia	a elección
blackgreen	Ⓝ a elección	denver oak	a elección	snow	a elección
carbón	carbón	roble bardolino	a elección	EG Melamina brillante	
delfin	delfin	roble natural	a elección	bianco	bianco
fango	a elección	roble sanremo	a elección	cachemir	a elección
grigio	a elección	vicenza oak claire	a elección	optiwhite	a elección
cachemir	a elección				
grava	a elección				
musgo	a elección				
muscata	a elección				
optiwhite	a elección				
orion	Ⓝ a elección				
sharky	a elección				
shell	Ⓝ a elección				
pizarra	pizarra				
stormgrey	Ⓝ a elección				

COSTADOS VISTOS CON SUPLEMENTO

COSTADO VISTO:	CARCASA:	COSTADO VISTO:	CARCASA:	COSTADO VISTO:	CARCASA:
ST Estructurado imitando madera		SM Estratificado mate		UVHG Lacado brillante	
amber	a elección	bianco	bianco	bianco	bianco
argento	a elección	magnolia	a elección	grigio	a elección
basalt oscuro	a elección	optiwhite	a elección	cachemir	a elección
negro (Cemento)	a elección	shell	Ⓝ a elección	optiwhite	a elección
halifax crack oak	a elección	SG Estratificado brillante		snow	a elección
halifax natural	a elección	bianco	bianco		
halifax tin dark	Ⓝ a elección	magnolia	a elección		
blanco Halifax	a elección	optiwhite	a elección		
roble nudoso	a elección	snow	a elección		
gris claro	a elección				
oxyde claro	a elección				
steel blue	a elección				
nogal	Ⓝ a elección				

S 126 MUEBLES ALTOS

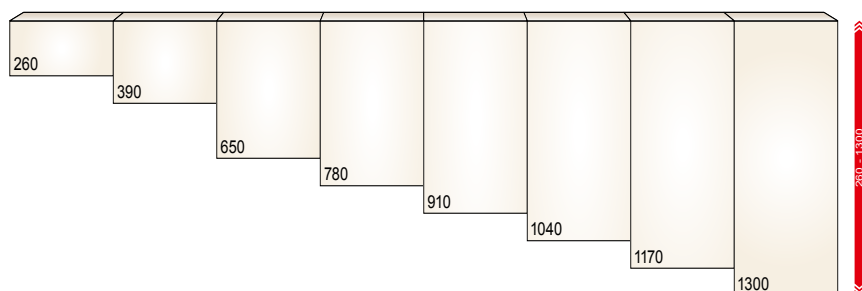

S 126 MUEBLES BAJOS

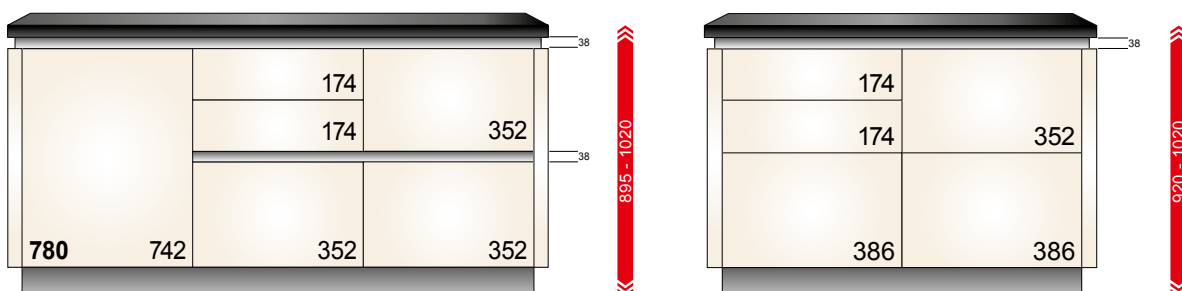

S 126 COLUMNAS

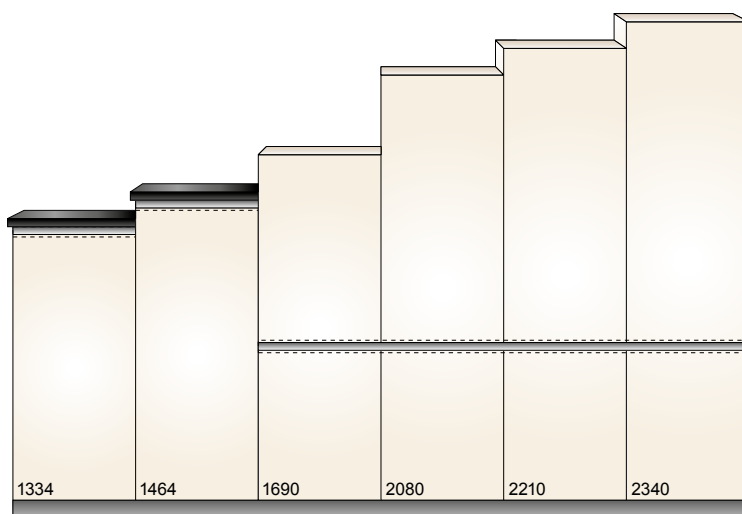

- GL
- GLD E/B
- GLV E/B
- GLX E
- GLV 45
- GLX 90
- GLU

S 126 COMBINACIONES DE ALTURAS ESTÁNDAR

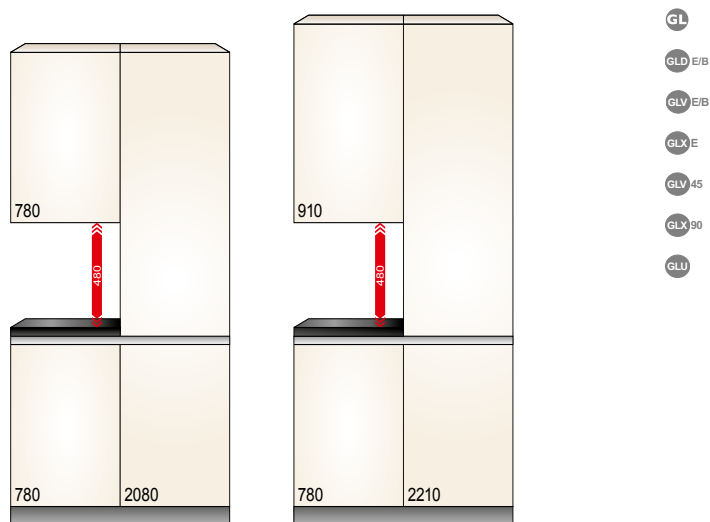

- GL
- GLD E/B
- GLV E/B
- GLX E
- GLV 45
- GLX 90
- GLU

medidas en mm

MUEBLES ALTOS

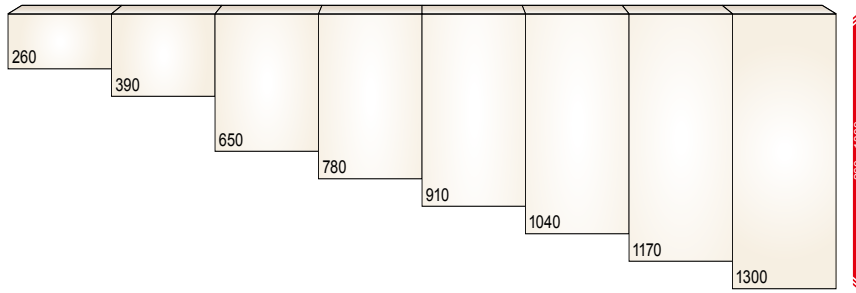

MUEBLES BAJOS

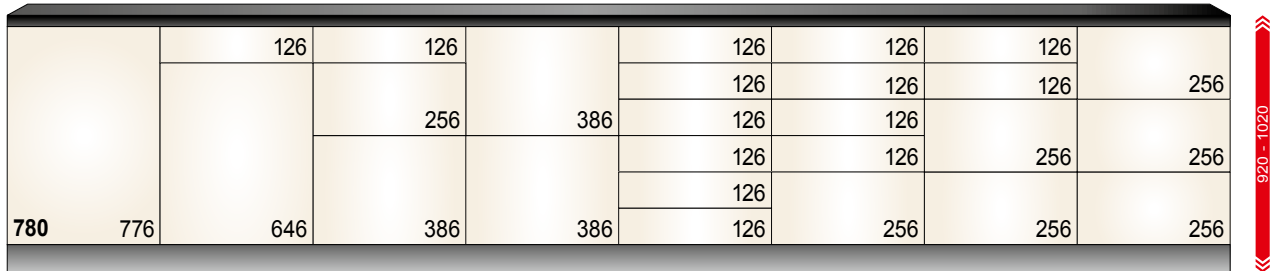

COLUMNAS

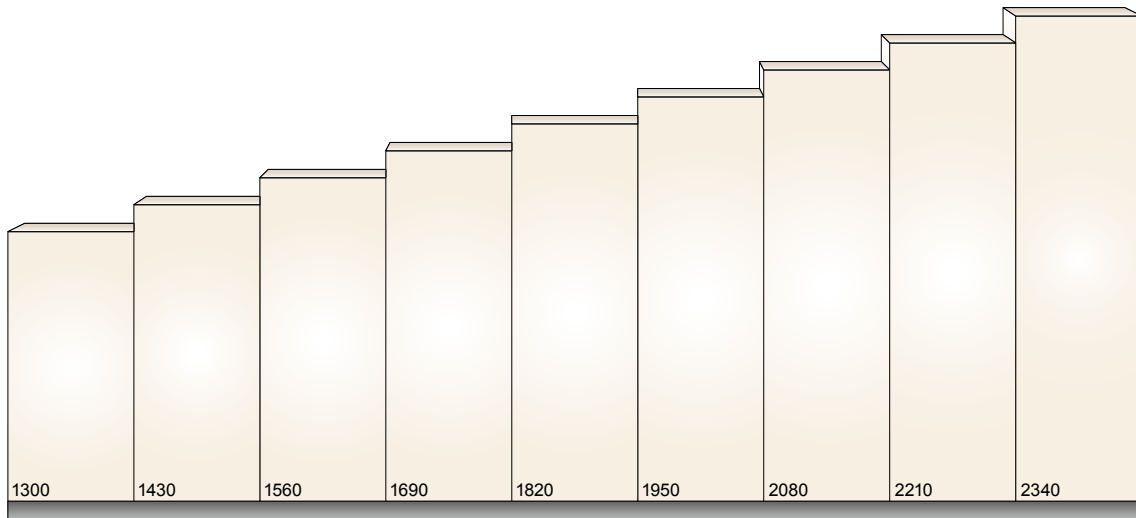

COMBINACIONES DE ALTURAS ESTÁNDAR

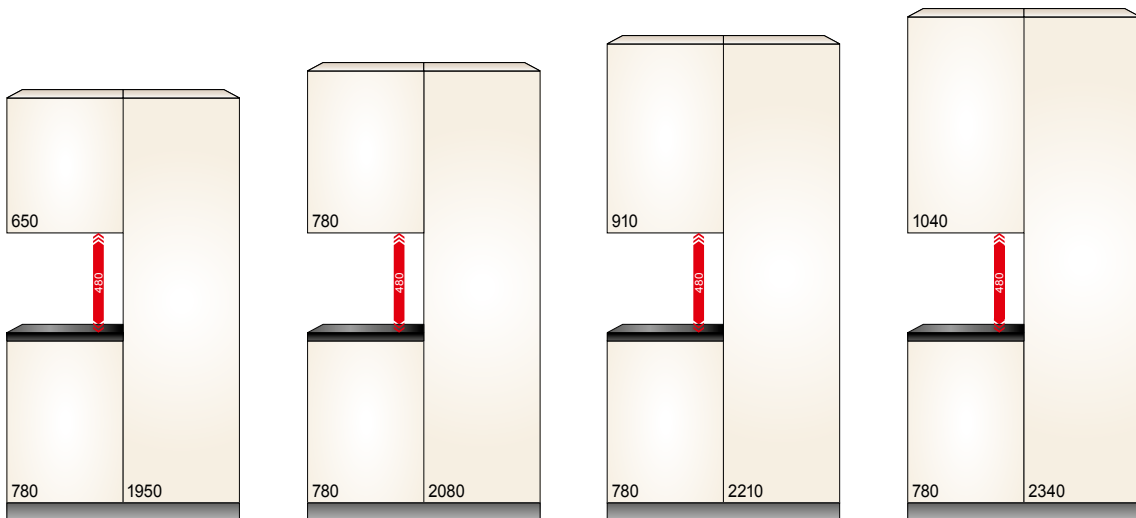

medidas en mm

MUEBLES ALTOS

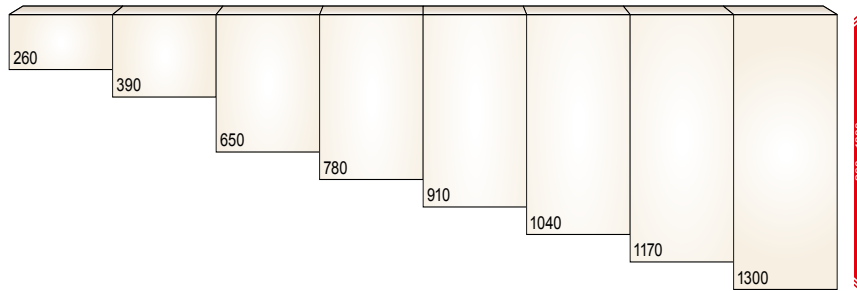

MUEBLES BAJOS

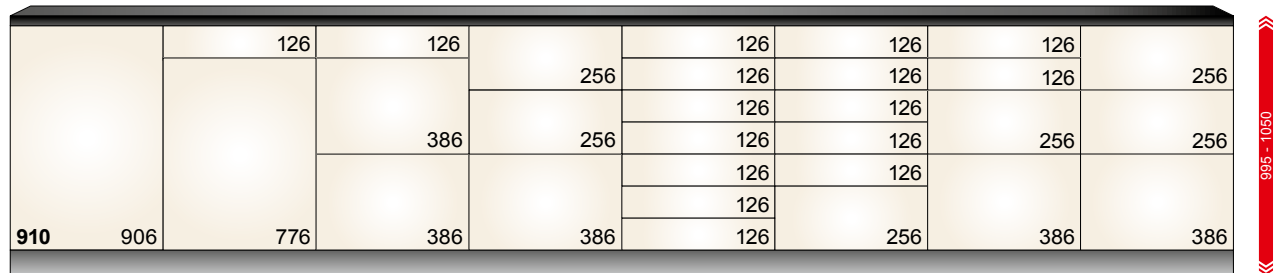

COLUMNAS

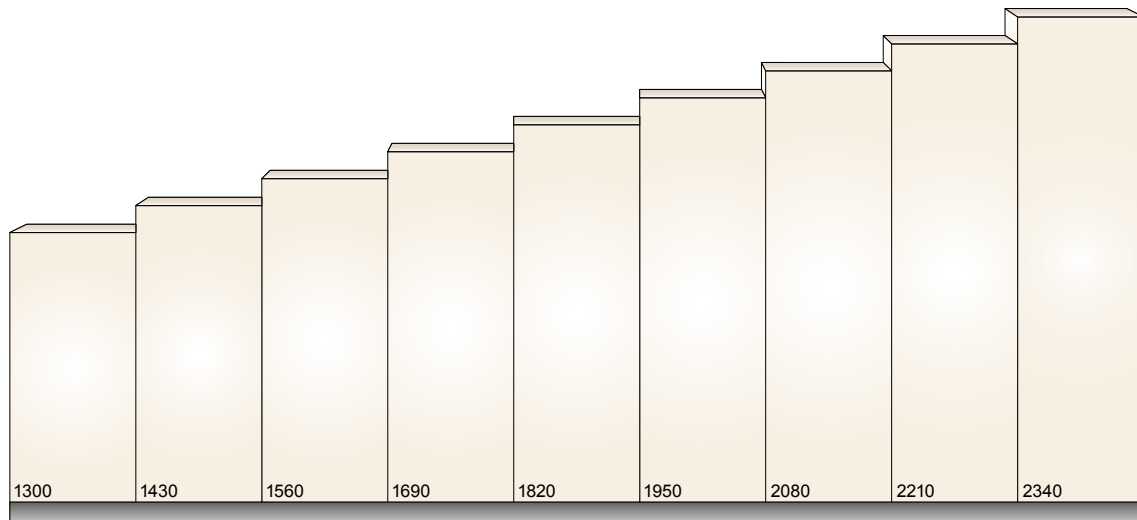

COMBINACIONES DE ALTURAS ESTÁNDAR

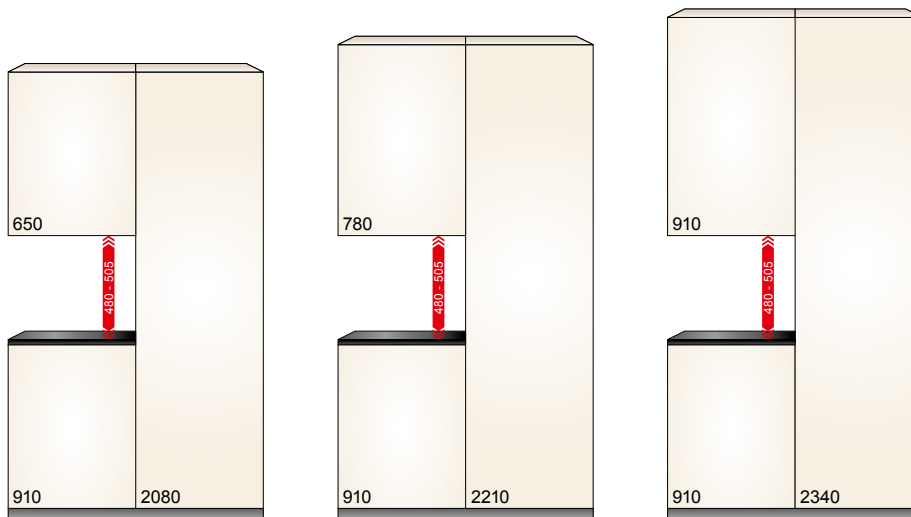

medidas en mm

medidas en mm

S 126 MUEBLES ALTOS

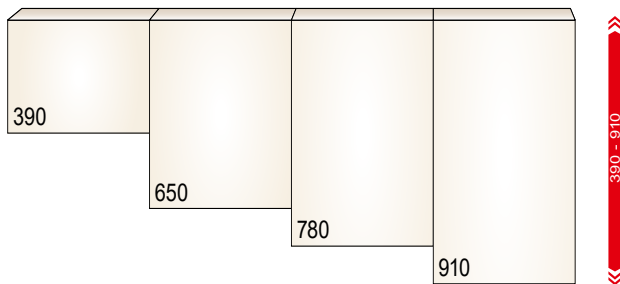

S 126 MUEBLES BAJOS

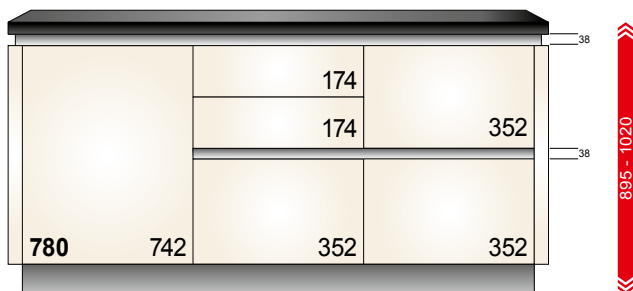

S 126 COLUMNAS

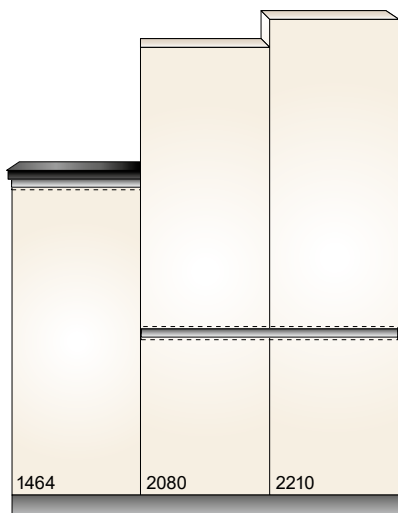

GL
GLD E/B

S 126 COMBINACIONES DE ALTURAS ESTÁNDAR

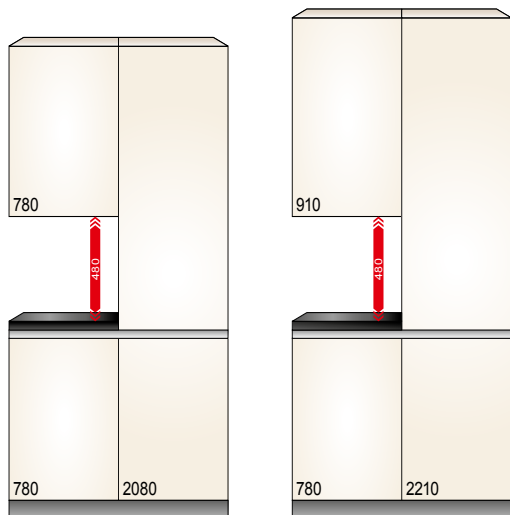

GL
GLD E/B

MUEBLES ALTOS

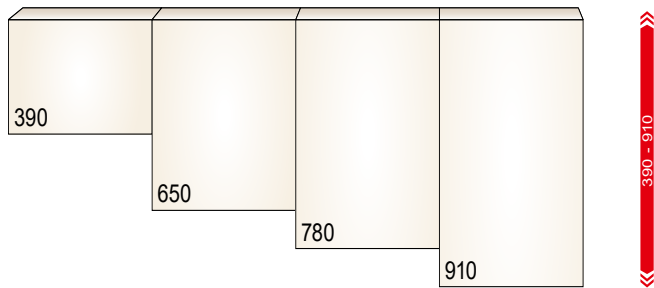

MUEBLES BAJOS

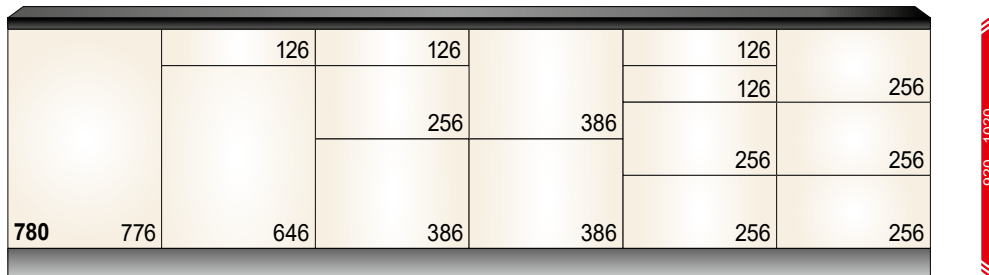

COLUMNAS

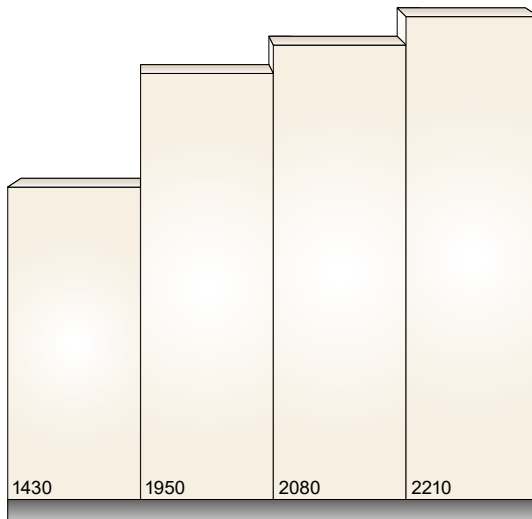

COMBINACIONES DE ALTURAS ESTÁNDAR

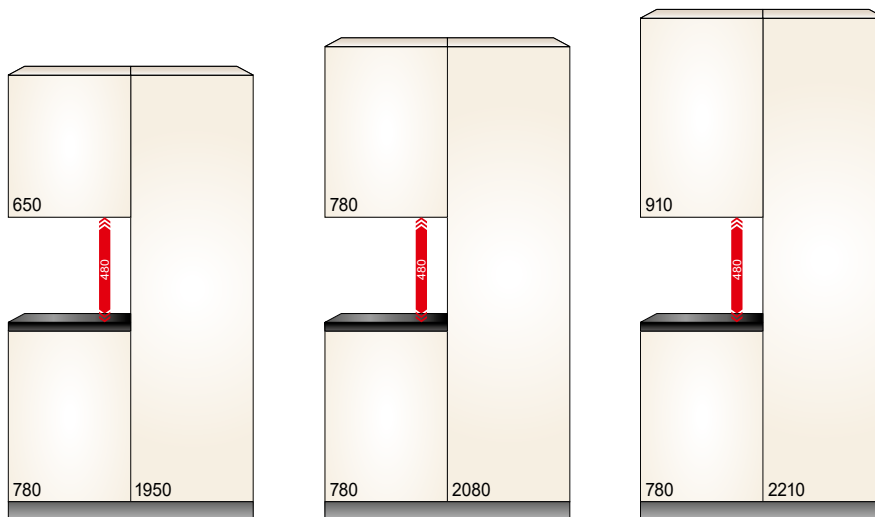

medidas en mm

S 126 MUEBLES ALTOS

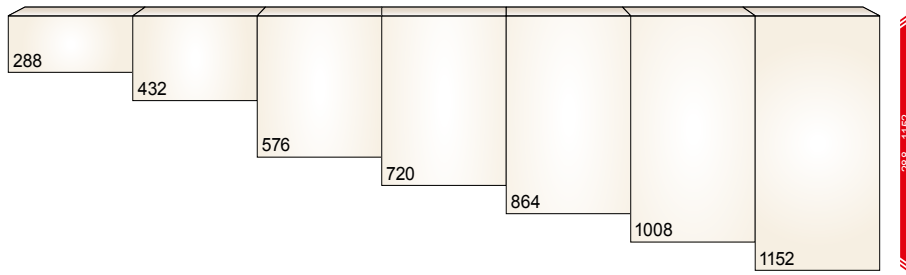

S 126 MUEBLES BAJOS

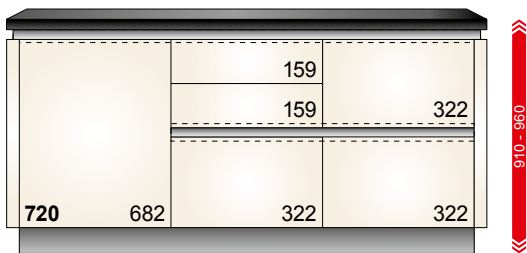

S 126 COLUMNAS

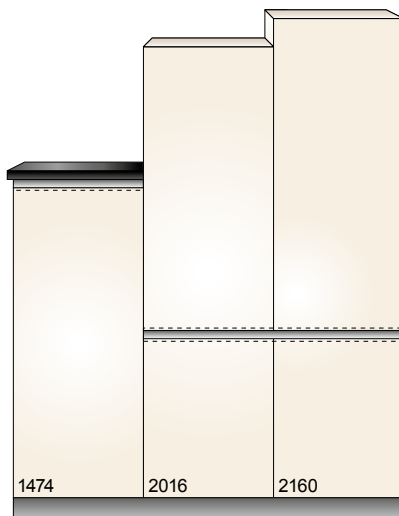

S 126 COMBINACIONES DE ALTURAS ESTÁNDAR

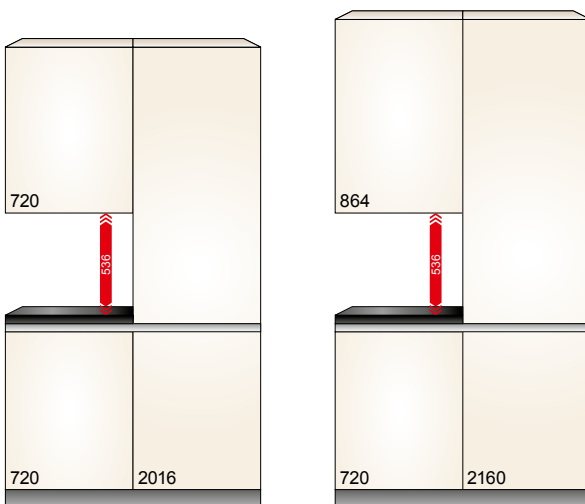

medidas en mm

MUEBLES ALTOS

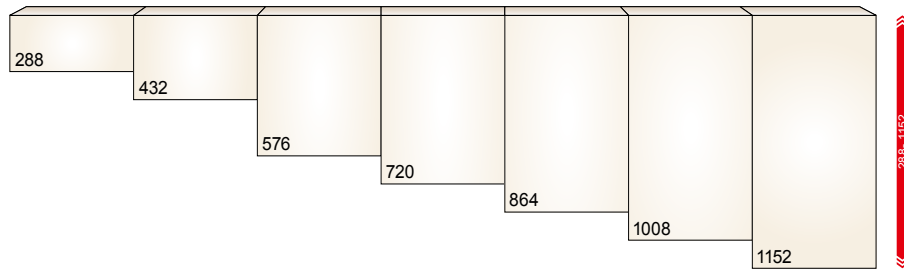

MUEBLES BAJOS

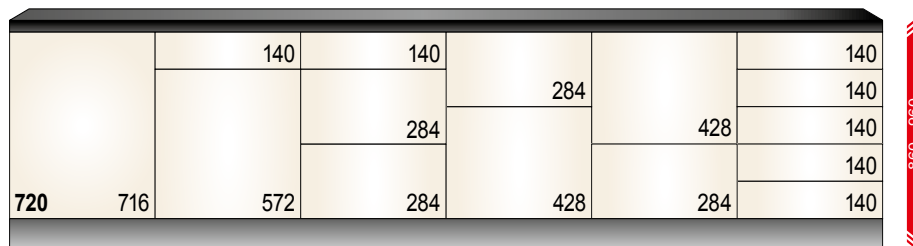

COLUMNAS

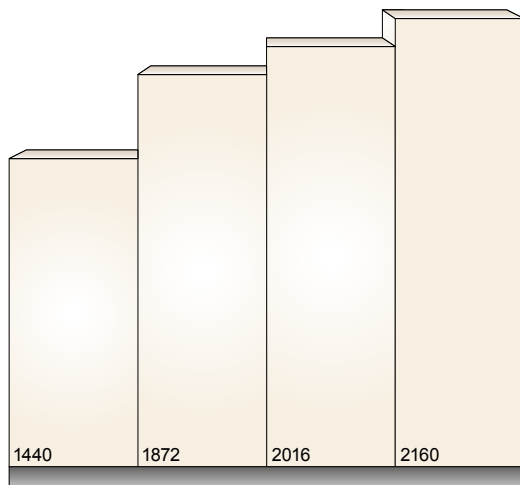

COMBINACIONES DE ALTURAS ESTÁNDAR

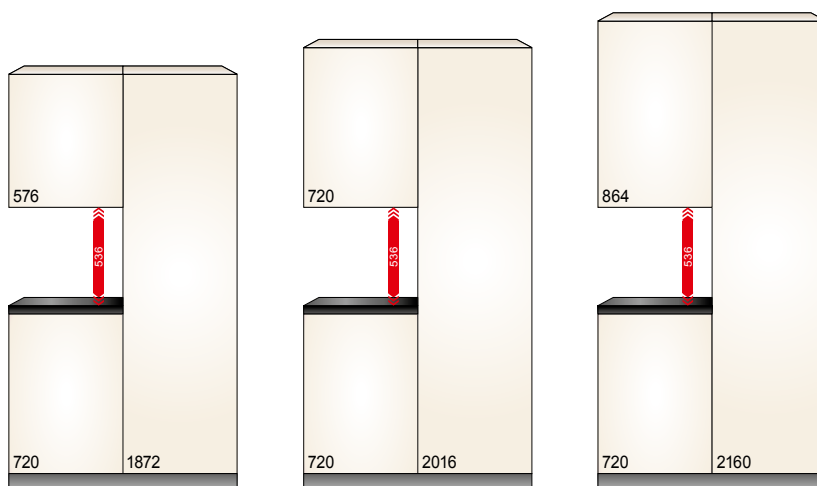

medidas en mm

Vitrinas universales

MARCO DE 20 MM	TIPOS DE VIDRIO	ALU	INOX	SNOW	NEGRO
		A20	I20	S20	B20
	Vidrio transparente (KG)	*	*	*	*
	Satinado mate (SAT M)	*	*	*	*
	Satinado brillante (SAT G)	*	*	*	*
	Vidrio negro brillante (SG G)	-	-	-	*

Marco alu de **20 x 20** mm, en los diferentes acabados disponibles. El marco está disponible sin tirador o con un pomo metálico.

Especificar el color de vidrio con el pedido.

MARCO DE 50 MM	TIPOS DE VIDRIO	ALU	INOX	SNOW	NEGRO
		A50	I50	S50	B50
	Vidrio transparente (KG)	*	*	*	*
	Satinado mate (SAT M)	*	*	*	*
	Satinado brillante (SAT G)	*	*	*	*
	Vidrio negro brillante (SG G)	-	-	-	*

Marco alu pulido **50 x 20** mm, en los diferentes acabados disponibles. El marco está disponible sin tirador o con tirador en barra STG/STGE/STGEB (con suplemento).



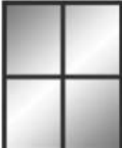

Especificar el color de vidrio con el pedido.

MARCO DE 55 CM	TIPOS DE VIDRIO	LOOK INDUSTRIAL
		IL55
	Vidrio transparente (KG)	*

Marco **55 x 20** mm look industrial. Únicamente disponible sin tiradores ni perforaciones. Tip-On requerido (con suplemento).

MARCO DE 20 MM	TIPOS DE VIDRIO	Puerta cruzada
		SP20
	Vidrio transparente (KG)	*

Marco **20 x 20** mm con barras cruzadas, en aluminio lacado negro. El marco está disponible sin tirador o con un pomo metálico.

TIPOS DE VIDRIO			
			
KG	SAT M	SAT G	SG G



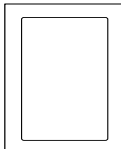
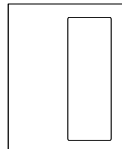
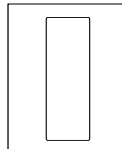
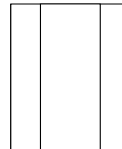
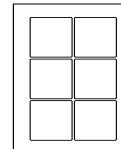
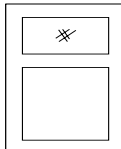

KG Vidrio transparente
SAT M Satinado mate
SAT G Satinado brillante
SG G Vidrio negro brillante

Vitrinas según modelo

R	G*/GA*	GM	L	K	H
					
KG	KG	KG	KG	KG	KG
SAT M	SAT M	SAT M	SAT M	SAT M	SAT M
SAT G	SAT G	SAT G	SAT G	SAT G	SAT G
SG G	SG G	SG G	SG G	SG G	SG G

G* Especificar si la parte vidriada es a la izquierda o a la derecha.

GA* Especificar si la parte vidriada es a la izquierda o a la derecha.

TIPOS DE VIDRIO			
			
KG	SAT M	SAT G	SG G

KG Vidrio transparente
SAT M Satinado mate
SAT G Satinado brillante
SG G Vidrio negro brillante



- Sistema metálico fino y elegante, en color gris antracita
- Los costados del cajón son totalmente rectos dentro y fuera con un grosor de 12,8 mm
- Trasera metálica
- Novedoso sistema de guías sobre las base
- Capacidad de carga de 40 kg hasta 60 cm de anchura y de 70 kg a partir de 80 cm de anchura
- Las guías son suaves y se deslizan sin esfuerzo incluso a plena carga
- Cierre silencioso y con freno gracias al sistema BLUMOTION
- Hundimiento mínimo gracias a la robustez del cajón
- Elementos de distribución interior a juego
- Disponible Tip-on blumotion para LEGRABOX (sistema push de apertura Tip-on para cajones y gaveteros)
- Servo-Drive Flex: para la apertura mecánica de combis o frigos y lavavajillas panelado



Legrabox - Free
con paredes de vidrio transparente de 10 mm (con sobrecoste)



Panel trasero de 5 mm de grosor en **DM (MDF)**
Estabilizado de mueble de madera maciza al frente

Profundidad de carcasa estándar de 575 mm, profundidad de 550 mm disponible sin suplemento

18 colores de carcasa disponible, posibilidad de tener el mismo acabado dentro y fuera

Cajón LEGRABOX de paredes metálicas sobre guías con freno

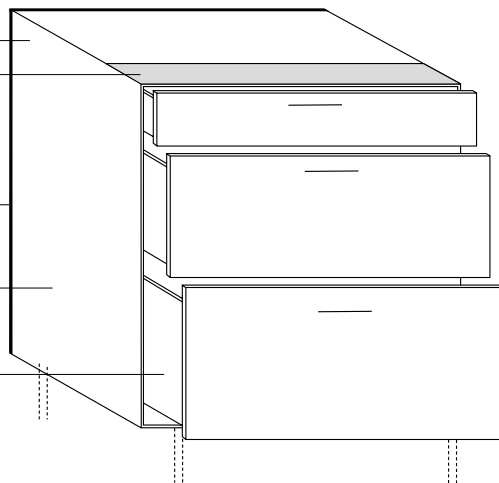

19 mm carcasa

Herrajes de suspensión invisibles

Panel trasero de 5 mm de grosor en **DM (MDF)**

Estantes regulables de 19 mm con pin anti movimiento

(N) Soportes de baldas de 3 mm en color oscuro

(N) Bisagras Blum negro onyx con freno integrado, bisagras de 180° con freno integrado

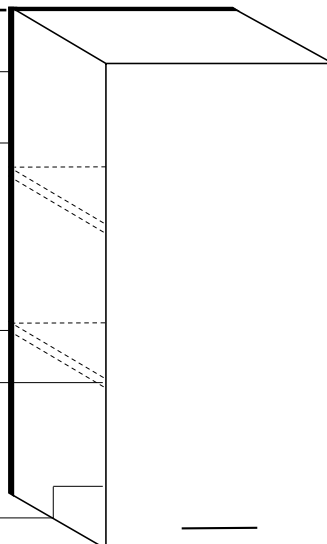

ELarge

XTend

EWide

DARK PERFECTION



Almacenamiento / Botiquines / LeMans: estándar con interior lacado en polvo color antracita





- Sistema de cajones y gaveteros Tandembox Antaro. Su estructura es en color gris orion mate.
- El modelo Tandembox Antaro se define por sus líneas y diseño claros y angulares (soportes rectangulares)
- Panel trasero metálico
- Extracción suave
- Capacidad de carga dinámica elevada: cajones hasta 60 cm de ancho, 30 kg de capacidad de carga a partir de 80 cm de anchura, hasta 50 kg de capacidad de carga
- alta estabilidad
- organizadores interiores y complementos oficiales
- Tip-on Blumotion disponible para elementos ANTARO (extracción mecánica mediante pulsación)

3 mm de grosor

Travesaño de DM (MDF) oscuro

Profundidad de carcasa estándar de 575 mm, profundidad de 550 mm disponible sin suplemento

4 colores de carcasa disponible, posibilidad de tener el mismo acabado dentro y fuera

BLUM TANDEMBOX ANTARO gris orion de paredes metálicas

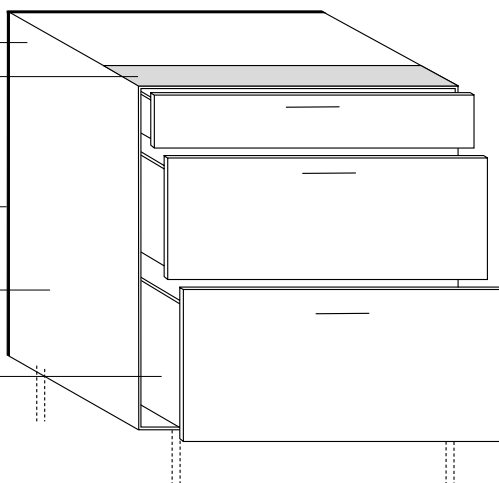

19 mm carcasa

Herrajes de suspensión visibles

Panel trasero de 3 mm

Estantes regulables de 19 mm con pin anti movimiento

Ⓝ Soportes de baldas de 3 mm en color oscuro

Ⓝ Bisagras Blum negro onyx con freno integrado, bisagras de 180° con freno integrado

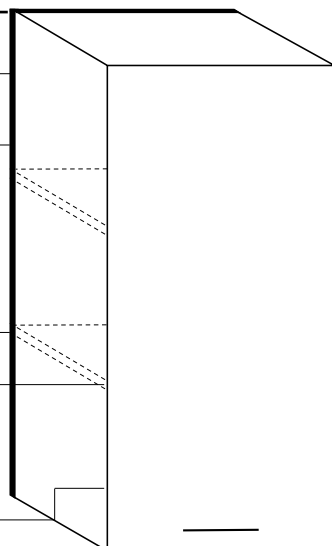

ELarge

XTend





- Sistema de cajones y gaveteros Tandembox Plus
Su estructura es en color gris orion mate.
- Elementos de soporte estructural cilíndricos
- Panel trasero metálico
- Extracción suave
- Capacidad de carga dinámica elevada:
cajones hasta 60 cm de ancho, 30 kg de capacidad de carga
a partir de 80 cm de anchura, hasta 50 kg de capacidad de carga
- alta estabilidad
- organizadores interiores y complementos oficiales
- Tip-on Blumotion disponible para elementos Tandembox
(extracción mecánica mediante pulsación)

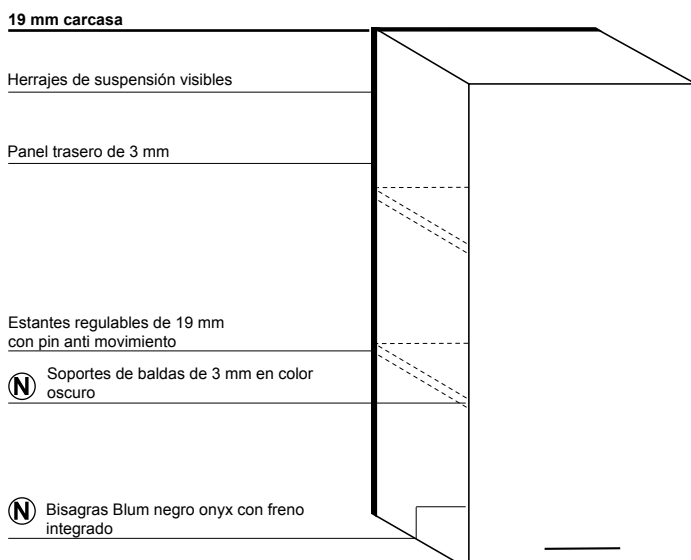
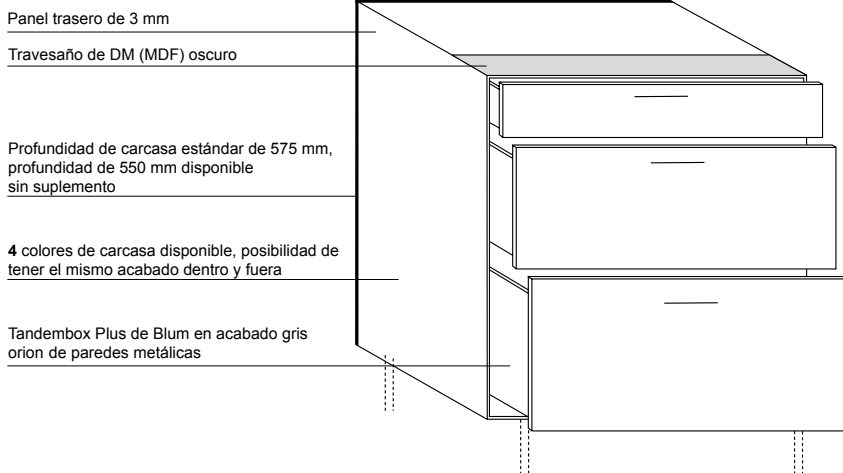

Acabados
en melamina



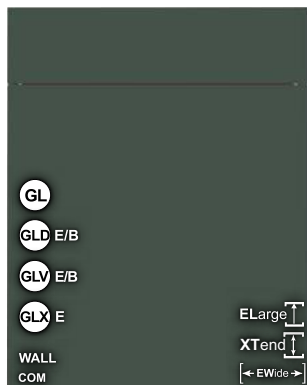

P
R
E
M
I
U
M

Vitrinas

G/GA/GM/R Vitrina con marco,
L vitrina con montantes verticales laterales

	TOUCH	COM	Color de frente	Carcasa	Costado visto	W 19	W50+100	XW5/ XW6	Zócalos	Estantes
	P108 260	P229 260	arcai-red	*	KS	KS	KS W100	KS	KS	-
GLV/45	P108 006	P229 006	bianco	KS	UM	UM	UM W100	UM	UM	UM
	P108 261	P229 261	blackblue	*	KS	KS	KS W100	KS	KS	-
	P108 262	P229 262	blackgreen	*	KS	KS	KS W100	KS	KS	-
GLV/45	P108 063	P229 063	carbón	KS	-	KS	KS	KS	KS	KS
GLV/45	P108 123	P229 123	delfin	KS	-	KS	KS	KS	KS	KS
GLV/45	P108 014	P229 014	fango	*	KS	KS	KS	KS	KS	KS
GLV/45	P108 095	P229 095	grigio	KS	-	KS	KS	KS	KS	KS
GLV/45	P108 024	P229 024	cachemir	KS	-	KS	KS	KS	KS	KS
GLV/45	P108 064	P229 064	grava	KS	-	KS	KS	KS	KS	KS
GLV/45	P108 090	P229 090	magnolia	KS	UM	UM	UM W100	UM	UM	UM
	P108 112	P229 112	musgo	*	KS	KS	KS W100	KS	KS	-
	P108 013	P229 013	muscata	*	KS	KS	KS	KS	KS	KS
	P108 007	P229 007	optiwhite	KS	-	KS	KS	KS	KS	KS
	P108 243	P229 243	orion	KS	-	KS	KS	KS	KS	KS
GLV/45	P108 126	P229 126	sharky	KS	-	KS	KS	KS	KS	KS
	P108 244	P229 244	shell	KS	-	KS	KS	KS	KS	KS
GLV/45	P108 128	P229 128	pizarra	KS	-	KS	KS	KS	KS	KS
GLV/45	P108 101	P229 101	snow	KS	UM	UM	UM W100	UM	UM	UM
	P108 263	P229 263	stormgrey	*	KS	KS	KS W100	KS	KS	-

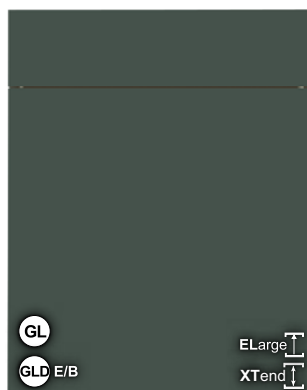

L
I
T
E

Vitrinas

Solo están disponibles las vitrinas universales

	TOUCH	Color de frente	Carcasa	Costado visto	W 19	W50+100	XW5/ XW6	Zócalos	Estantes
	L108 260	arcai-red	*	KS	KS	KS W100	KS	KS	-
	L108 006	bianco	KS	UM	UM	UM W100	UM	UM	UM
	L108 261	blackblue	*	KS	KS	KS W100	KS	KS	-
	L108 262	blackgreen	*	KS	KS	KS W100	KS	KS	-
	L108 063	carbón	KS	-	KS	KS	KS	KS	KS
	L108 123	delfin	KS	-	KS	KS	KS	KS	KS
	L108 014	fango	*	KS	KS	KS	KS	KS	KS
	L108 095	grigio	*	KS	KS	KS	KS	KS	KS
	L108 024	cachemir	*	KS	KS	KS	KS	KS	KS
	L108 064	grava	*	KS	KS	KS	KS	KS	KS
	L108 090	magnolia	*	UM	UM	UM W100	UM	UM	UM
	L108 112	musgo	*	KS	KS	KS W100	KS	KS	-
	L108 013	muscata	*	KS	KS	KS	KS	KS	KS
	L108 007	optiwhite	*	KS	KS	KS	KS	KS	KS
	L108 243	orion	*	KS	KS	KS	KS	KS	KS
	L108 126	sharky	*	KS	KS	KS	KS	KS	KS
	L108 244	shell	*	KS	KS	KS	KS	KS	KS
	L108 128	pizarra	KS	-	KS	KS	KS	KS	KS
	L108 101	snow	*	UM	UM	UM W100	UM	UM	UM
	L108 263	stormgrey	*	KS	KS	KS W100	KS	KS	-

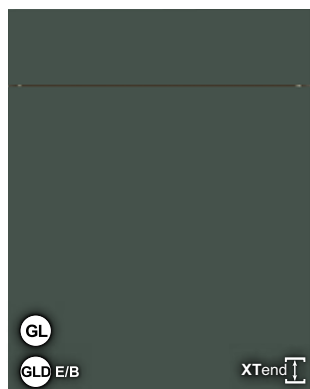

NEW

Vitrinas
R Vitrina con marco cuadrado,
L Vitrina con montantes verticales

TOUCH	Color de frente	Carcasa	Costado visto	W 19	W50+100	XW5/XW6	Zócalos	Estantes
N108 260	arcai-red	*	KS	KS	-	KS	KS	-
N108 006	bianco	KS	UM	UM	-	UM	UM	UM
N108 261	blackblue	*	KS	KS	-	KS	KS	-
N108 262	blackgreen	*	KS	KS	-	KS	KS	-
N108 063	carbón	KS	-	KS	-	KS	KS	KS
N108 123	delfin	KS	-	KS	-	KS	KS	KS
N108 014	fango	*	KS	KS	-	KS	KS	KS
N108 095	grigio	*	KS	KS	-	KS	KS	KS
N108 024	cachemir	*	KS	KS	-	KS	KS	KS
N108 064	grava	*	KS	KS	-	KS	KS	KS
N108 090	magnolia	*	UM	UM	-	UM	UM	UM
N108 112	musgo	*	KS	KS	-	KS	KS	-
N108 013	muscata	*	KS	KS	-	KS	KS	KS
N108 007	optiwhite	*	KS	KS	-	KS	KS	KS
N108 243	orion	*	KS	KS	-	KS	KS	KS
N108 126	sharky	*	KS	KS	-	KS	KS	KS
N108 244	shell	*	KS	KS	-	KS	KS	KS
N108 128	pizarra	KS	-	KS	-	KS	KS	KS
N108 101	snow	*	UM	UM	-	UM	UM	UM
N108 263	stormgrey	*	KS	KS	-	KS	KS	-



Acabado melamina Mate Fina (KS) / Ultra Mate (UM)
y canto sin juntas. La textura puede variar según los acabados.

Configuración de posiciones de tirador TOUCH

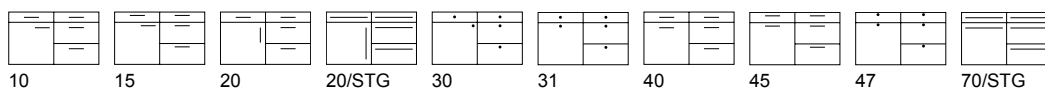

Acabados en melamina

Acabados mates

Acabados brillantes

Acabados polilaminados

Wood Range + Wood Specials

Tiradores, encimeras, tablas de acabados, modelos descatalogados



PREMIUM

PORTO H	COM	Color de frente	Carcasa	Costado visto	W 19	W50+100	XW5/ XW6	Zócalos	Estantes
P105 006	P250 006	bianco, H	KS	WL	WL	WL	WL	WL	WL
P105 267	P250 267	black burned, H	*	WL	WL	WL W100	WL	WL	-
P105 023	P250 023	roble denver, H	*	WL	WL	WL W100	WL	WL	-
P105 045	P250 045	roble bardolino, H	*	WL	WL	WL	WL	WL	WL
P105 028	P250 028	roble natural, H	KS	-	WL	WL	WL	WL	WL

PORTO V	COM	Color de frente	Carcasa	Costado visto	W 19	W50+100	XW5/ XW6	Zócalos	Estantes
P104 006	P249 006	bianco, V	KS	WL	WL	WL	WL	WL	WL
P104 267	P249 267	black burned, V	*	WL	WL	WL W100	WL	WL	-
P104 023	P249 023	roble denver, V	*	WL	WL	WL W100	WL	WL	-
P104 045	P249 045	roble bardolino, V	*	WL	WL	WL	WL	WL	WL
P104 028	P249 028	roble natural, V	KS	-	WL	WL	WL	WL	WL

Vitrinas

G/GA/GM/R Vitrina con marco cuadrado,
L Vitrina con montantes verticales



LITE

PORTO H	Color de frente	Carcasa	Costado visto	W 19	W50+100	XW5/ XW6	Zócalos	Estantes
L105 006	bianco, H	KS	WL	WL	WL	WL	WL	WL
L105 267	black burned, H	*	WL	WL	WL W100	WL	WL	-
L105 023	roble denver, H	*	WL	WL	WL W100	WL	WL	-
L105 045	roble bardolino, H	*	WL	WL	WL	WL	WL	WL
L105 028	roble natural, H	*	WL	WL	WL	WL	WL	WL

PORTO V	Color de frente	Carcasa	Costado visto	W 19	W50+100	XW5/ XW6	Zócalos	Estantes
L104 006	bianco, V	KS	WL	WL	WL	WL	WL	WL
L104 267	black burned, V	*	WL	WL	WL W100	WL	WL	-
L104 023	roble denver, V	*	WL	WL	WL W100	WL	WL	-
L104 045	roble bardolino, V	*	WL	WL	WL	WL	WL	WL
L104 028	roble natural, V	*	WL	WL	WL	WL	WL	WL

Vitrinas

Solo están disponibles las vitrinas universales



NEW

PORTO H	Color de frente	Carcasa	Costado visto	W 19	W50+100	XW5/ XW6	Zócalos	Estantes
N105 006	bianco, H	KS	WL	WL	-	WL	WL	WL
N105 267	black burned, H	*	WL	WL	-	WL	WL	-
N105 023	roble denver, H	*	WL	WL	-	WL	WL	-
N105 045	roble bardolino, H	*	WL	WL	-	WL	WL	WL
N105 028	roble natural, H	*	WL	WL	-	WL	WL	WL

PORTO V	Color de frente	Carcasa	Costado visto	W 19	W50+100	XW5/ XW6	Zócalos	Estantes
N104 006	bianco, V	KS	WL	WL	-	WL	WL	WL
N104 267	black burned, V	*	WL	WL	-	WL	WL	-
N104 023	roble denver, V	*	WL	WL	-	WL	WL	-
N104 045	roble bardolino, V	*	WL	WL	-	WL	WL	WL
N104 028	roble natural, V	*	WL	WL	-	WL	WL	WL

Vitrinas

R Vitrina con marco cuadrado,
L Vitrina con montantes verticales

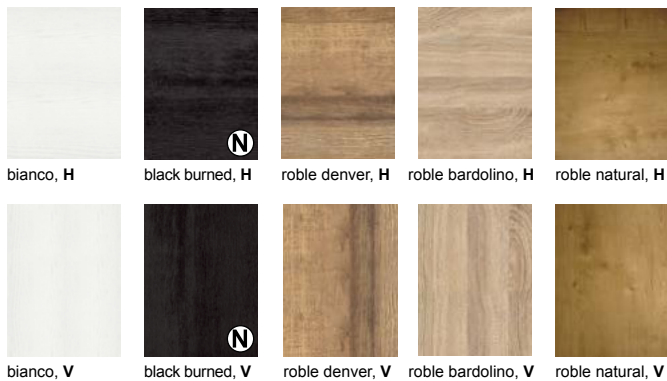

Melamina con canteado PP de 0,8 mm de grosor.
Acabado madera en estilo woodline con **vetado horizontal/vertical** simulando madera.

Configuración de posiciones de tirador PORTO H+V woodline

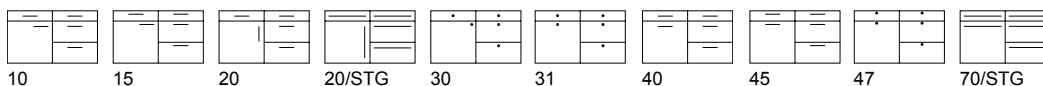



P R E M I U M

ALBERO H	COM	Color de frente	Carcasa	Costado visto	W 19	W 100	XW5/XW6	Zócalos	Estantes
P116 252	P211 252	negro, H	KS	ST	ST	ST	ST	ST	ST
P116 253	P211 253	café, H	*	ST	ST	ST	ST	ST	ST
P116 255	P211 255	nature, H	*	ST	ST	ST	ST	ST	ST
P116 254	P211 254	noce, H	*	ST	ST	ST	ST	ST	ST

ALBERO V	COM	Color de frente	Carcasa	Costado visto	W 19	W 100	XW5/XW6	Zócalos	Estantes
P117 252	P212 252	negro, V	KS	ST	ST	ST	ST	ST	ST
P117 253	P212 253	café, V	*	ST	ST	ST	ST	ST	ST
P117 255	P212 255	nature, V	*	ST	ST	ST	ST	ST	ST
P117 254	P212 254	noce, V	*	ST	ST	ST	ST	ST	ST

Vitrinas

G/GA/GM/R Vitrina con marco cuadrado,
L Vitrina con montantes verticales



L I T E

ALBERO H	Color de frente	Carcasa	Costado visto	W 19	W 100	XW5/XW6	Zócalos	Estantes
L116 252	negro, H	*	ST	ST	ST	ST	ST	ST
L116 253	café, H	*	ST	ST	ST	ST	ST	ST
L116 255	nature, H	*	ST	ST	ST	ST	ST	ST
L116 254	noce, H	*	ST	ST	ST	ST	ST	ST

ALBERO V	Color de frente	Carcasa	Costado visto	W 19	W 100	XW5/XW6	Zócalos	Estantes
L117 252	negro, V	*	ST	ST	ST	ST	ST	ST
L117 253	café, V	*	ST	ST	ST	ST	ST	ST
L117 255	nature, V	*	ST	ST	ST	ST	ST	ST
L117 254	noce, V	*	ST	ST	ST	ST	ST	ST

Vitrinas

Solo están disponibles las vitrinas universales

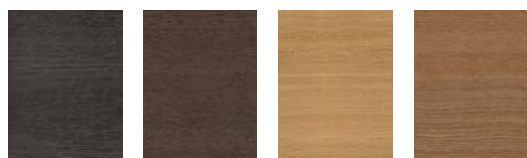

negro, H café, H nature, H noce, H



negro, V café, V nature, V noce, V

Lamina gruesa de melamina texturizada coincidente con el veteado. Veta **horizontal/vertical**. Canteado igual a frente, parte trasera del mismo color

Configuración de posiciones de tirador ALBERO H+V

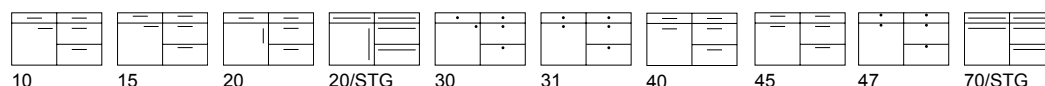

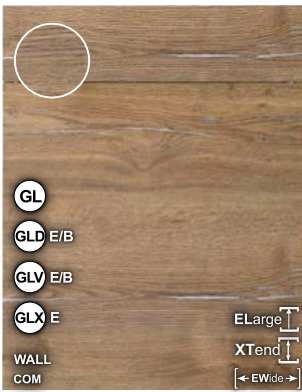

**P
R
E
M
I
U
M**

	SINCRONO H	COM	Frontfarbe	Korpus	Costado visto	W 19	W50+100	XW5/ XW6	Socket	Regal
GLV 45	P114 200	P206 200	argento, H	*	ST	ST	ST	ST	ST	ST
GLV 45	P114 199	P206 199	halifax crack oak, H	KS	-	ST	ST	ST	ST	ST
GLV 45	P114 175	P206 175	natural Halifax, H	*	ST	ST	ST	ST	ST	ST
GLV 45	P114 266	P206 266	halifax tin dark, H	*	ST	ST	ST W100	ST	ST	ST
GLV 45	P114 145	P206 145	blanco Halifax, H	*	ST	ST	ST	ST	ST	ST
GLV 45	P114 115	P206 115	roble nudoso, H	*	ST	ST	ST	ST	ST	ST
GLV 45	P114 046	P206 046	roble sanremo, H	*	WL	WL	WL	WL	WL	WL

	SINCRONO V	COM	Color de frente	Carcasa	Costado visto	W 19	W50+100	XW5/ XW6	Zócalos	Estantes
GLV 45	P115 200	P207 200	argento, V	*	ST	ST	ST	ST	ST	ST
GLV 45	P115 199	P207 199	halifax crack oak, V	KS	-	ST	ST	ST	ST	ST
GLV 45	P115 175	P207 175	natural Halifax, V	*	ST	ST	ST	ST	ST	ST
GLV 45	P115 266	P207 266	halifax tin dark, V	*	ST	ST	ST W100	ST	ST	ST
GLV 45	P115 145	P207 145	blanco Halifax, V	*	ST	ST	ST	ST	ST	ST
GLV 45	P115 115	P207 115	roble nudoso, V	*	ST	ST	ST	ST	ST	ST
GLV 45	P115 046	P207 046	roble sanremo, V	*	WL	WL	WL	WL	WL	WL

Vitrinas
G/GA/GM/R Vitrina con marco cuadrado,
L Vitrina con montantes verticales



**L
I
T
E**

	SINCRONO H	Color de frente	Carcasa	Costado visto	W 19	W50+100	XW5/ XW6	Zócalos	Estantes
	L114 200	argento, H	*	ST	ST	ST	ST	ST	ST
	L114 199	halifax crack oak, H	*	ST	ST	ST	ST	ST	ST
	L114 175	natural Halifax, H	*	ST	ST	ST	ST	ST	ST
	L114 266	halifax tin dark, H	*	ST	ST	ST W100	ST	ST	ST
	L114 145	blanco Halifax, H	*	ST	ST	ST	ST	ST	ST
	L114 115	roble nudoso, H	*	ST	ST	ST	ST	ST	ST
	L114 046	roble sanremo, H	*	WL	WL	WL	WL	WL	WL

	SINCRONO V	Color de frente	Carcasa	Costado visto	W 19	W50+100	XW5/ XW6	Zócalos	Estantes
	L115 200	argento, H	*	ST	ST	ST	ST	ST	ST
	L115 199	halifax crack oak, V	*	ST	ST	ST	ST	ST	ST
	L115 175	natural Halifax, V	*	ST	ST	ST	ST	ST	ST
	L115 266	halifax tin dark, V	*	ST	ST	ST W100	ST	ST	ST
	L115 145	blanco Halifax, V	*	ST	ST	ST	ST	ST	ST
	L115 115	roble nudoso, V	*	ST	ST	ST	ST	ST	ST
	L115 046	roble sanremo, V	*	WL	WL	WL	WL	WL	WL

Vitrinas
Solo están disponibles las vitrinas universales



NEW

Vitrinas
R Vitrina con marco cuadrado,
L Vitrina con montantes verticales

SINCRONO H	Color de frente	Carcasa	Costado visto	W 19	W50+100	XW5/ XW6	Zócalos	Estantes
N114 200	argento, H	*	ST	ST	-	ST	ST	ST
N114 199	halifax crack oak, H	*	ST	ST	-	ST	ST	ST
N114 175	natural Halifax, H	*	ST	ST	-	ST	ST	ST
N114 266	halifax tin dark, H	*	ST	ST	-	ST	ST	ST
N114 145	blanco Halifax, H	*	ST	ST	-	ST	ST	ST
N114 115	roble nudoso, H	*	ST	ST	-	ST	ST	ST
N114 046	roble sanremo, H	*	WL	WL	-	WL	WL	WL

SINCRONO V	Color de frente	Carcasa	Costado visto	W 19	W50+100	XW5/ XW6	Zócalos	Estantes
N115 200	argento, V	*	ST	ST	-	ST	ST	ST
N115 199	halifax crack oak, V	*	ST	ST	-	ST	ST	ST
N115 175	natural Halifax, V	*	ST	ST	-	ST	ST	ST
N115 266	halifax tin dark, V	*	ST	ST	-	ST	ST	ST
N115 145	blanco Halifax, V	*	ST	ST	-	ST	ST	ST
N115 115	roble nudoso, V	*	ST	ST	-	ST	ST	ST
N115 046	roble sanremo, V	*	WL	WL	-	WL	WL	WL



Melamina texturizada imitando madera con veteado horizontal/vertical con canteado grueso PP en acabado idéntico.

Configuración de posiciones de tirador

SINCRONO H+V

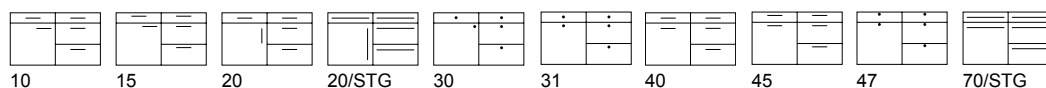



PREMIUM

Vitrinas
G/GA/GM/R Vitrina con marco cuadrado,
L Vitrina con montantes verticales

	SHERWOOD H	COM	Color de frente	Carcasa	Costado visto	W 19	W 100	XW5/ XW6	Zócalos	Estantes
GLV 45	P140 122	P290 122	negro, H	KS	ST	ST	ST	ST	ST	ST
	P140 198	P290 198	burned wood, H	*	ST	ST	ST	ST	ST	-
GLV 45	P140 142	P290 142	bushy park, H	*	ST	ST	ST	ST	ST	ST
GLV 45	P140 092	P290 092	cigar, H	*	ST	ST	ST	ST	ST	ST
GLV 45	P140 093	P290 093	engadina, H	*	ST	ST	ST	ST	ST	ST
	P140 203	P290 203	grafito, H	KS	ST	ST	ST	ST	ST	ST
GLV 45	P140 144	P290 144	greenwich, H	*	ST	ST	ST	ST	ST	ST
GLV 45	P140 195	P290 195	natural, H	*	ST	ST	ST	ST	ST	ST

	SHERWOOD V	COM	Color de frente	Carcasa	Costado visto	W 19	W 100	XW5/ XW6	Zócalos	Estantes
GLV 45	P141 122	P291 122	negro, V	KS	ST	ST	ST	ST	ST	ST
	P141 198	P291 198	burned wood, V	*	ST	ST	ST	ST	ST	-
GLV 45	P141 142	P291 142	bushy park, V	*	ST	ST	ST	ST	ST	ST
GLV 45	P141 092	P291 092	cigar, V	*	ST	ST	ST	ST	ST	ST
GLV 45	P141 093	P291 093	engadina, V	*	ST	ST	ST	ST	ST	ST
	P141 203	P291 203	grafito, V	KS	ST	ST	ST	ST	ST	ST
GLV 45	P141 144	P291 144	greenwich, V	*	ST	ST	ST	ST	ST	ST
GLV 45	P141 195	P291 195	natural, V	*	ST	ST	ST	ST	ST	ST



LITE

Vitrinas
Solo están disponibles las vitrinas universales

	SHERWOOD H	Color de frente	Carcasa	Costado visto	W 19	W 100	XW5/ XW6	Zócalos	Estantes
	L140 122	negro, H	*	ST	ST	ST	ST	ST	ST
	L140 198	burned wood, H	*	ST	ST	ST	ST	ST	-
	L140 142	bushy park, H	*	ST	ST	ST	ST	ST	ST
	L140 092	cigar, H	*	ST	ST	ST	ST	ST	ST
	L140 093	engadina, H	*	ST	ST	ST	ST	ST	ST
	L140 203	grafito, H	*	ST	ST	ST	ST	ST	ST
	L140 144	greenwich, H	*	ST	ST	ST	ST	ST	ST
	L140 195	natural, H	*	ST	ST	ST	ST	ST	ST

	SHERWOOD V	Color de frente	Carcasa	Costado visto	W 19	W 100	XW5/ XW6	Zócalos	Estantes
	L141 122	negro, V	*	ST	ST	ST	ST	ST	ST
	L141 198	burned wood, V	*	ST	ST	ST	ST	ST	-
	L141 142	bushy park, V	*	ST	ST	ST	ST	ST	ST
	L141 092	cigar, V	*	ST	ST	ST	ST	ST	ST
	L141 093	engadina, V	*	ST	ST	ST	ST	ST	ST
	L141 203	grafito, V	*	ST	ST	ST	ST	ST	ST
	L141 144	greenwich, V	*	ST	ST	ST	ST	ST	ST
	L141 195	natural, V	*	ST	ST	ST	ST	ST	ST



Lamina gruesa de melamina texturizada coincidente con el veteado. Veta **horizontal/vertical**. Canteado de 1 mm a cuatro cantos.

Configuración de posiciones de tirador SHERWOOD H+V

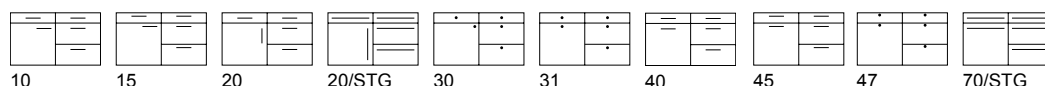



PREMIUM

Vitrinas
G/GA/GM/R Vitrina con marco cuadrado,
L Vitrina con montantes verticales

SMART H COM	Color de frente	Carcasa	Costado visto	W 19	W50+100	XW5/XW6	Zócalos	Estantes
P148 153	P279 153 vic. oak claire, H	-	WL	WL	WL	WL	WL	WL
P148 216	P279 216 nogal, H	KS	-	ST	ST	ST	ST	ST

SMART V COM	Color de frente	Carcasa	Costado visto	W 19	W50+100	XW5/XW6	Zócalos	Estantes
P149 153	P280 153 vic. oak claire, V	-	WL	WL	WL	WL	WL	WL
P149 216	P280 216 nogal, V	KS	-	ST	ST	ST	ST	ST

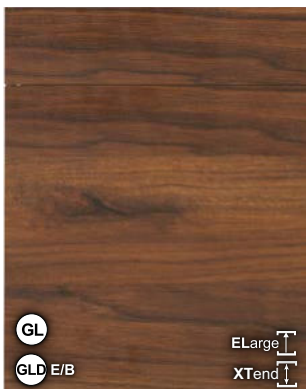

LITE

Vitrinas
Solo están disponibles las vitrinas universales

SMART H	Color de frente	Carcasa	Costado visto	W 19	W50+100	XW5/XW6	Zócalos	Estantes
L148 153	vic. oak claire, H	*	WL	WL	WL	WL	WL	WL
L148 216	nogal, H	*	ST	ST	ST	ST	ST	ST

SMART V	Color de frente	Carcasa	Costado visto	W 19	W50+100	XW5/XW6	Zócalos	Estantes
L149 153	vic. oak claire, V	*	WL	WL	WL	WL	WL	WL
L149 216	nogal, V	*	ST	ST	ST	ST	ST	ST



NEW

Vitrinas
R Vitrina con marco cuadrado,
L Vitrina con montantes verticales

SMART H	Color de frente	Carcasa	Costado visto	W 19	W50+100	XW5/XW6	Zócalos	Estantes
N148 153	vic. oak claire, H	*	WL	WL	-	WL	WL	WL
N148 216	nogal, H	*	ST	ST	-	ST	ST	ST

SMART V	Color de frente	Carcasa	Costado visto	W 19	W50+100	XW5/XW6	Zócalos	Estantes
N149 153	vic. oak claire, V	*	WL	WL	-	WL	WL	WL
N149 216	nogal, V	*	ST	ST	-	ST	ST	ST



vic. oak claire, H nogal, H

Frente: Melamina con acabado imitando vetado de madera (**horizontal/vertical**) con canto de PP, parte trasera del mismo color



vic. oak claire, V nogal, V

Configuración de posiciones de tirador SMART H+V

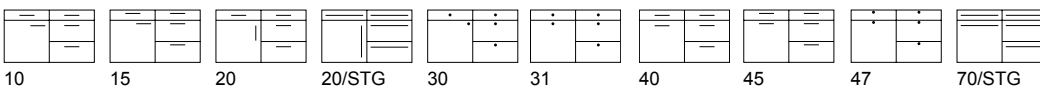

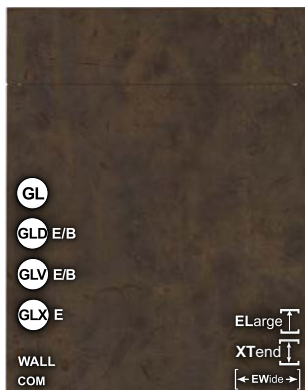

**P
R
E
M
I
U
M**

	CEMENTO	COM	Color de frente	Carcasa	Costado visto	W 19	W 100	XW5/ XW6	Zócalos	Estantes
GLV 45	P170 205	P270 205	amber	*	ST	ST	ST	ST	ST	ST
GLV 45	P170 096	P270 096	basalt oscuro	*	ST	ST	ST	ST	ST	ST
GLV 45	P170 022	P270 022	negro	KS	ST	ST	ST	ST	ST	ST
	P170 039	P270 039	bronce	*	ST	ST	ST	ST	ST	ST
	P170 040	P270 040	gris claro	*	ST	ST	ST	ST	ST	ST
GLV 45	P170 097	P270 097	oxyde claro	*	ST	ST	ST	ST	ST	ST
GLV 45	P170 118	P270 118	acero azul	*	ST	ST	ST	ST	ST	ST

Vitrinas

G/GA/GM/R Vitrina con marco cuadrado,
L Vitrina con montantes verticales



**L
I
T
E**

	CEMENTO	Color de frente	Carcasa	Costado visto	W 19	W 100	XW5/ XW6	Zócalos	Estantes
	L170 205	amber	*	ST	ST	ST	ST	ST	ST
	L170 096	basalt oscuro	*	ST	ST	ST	ST	ST	ST
	L170 022	negro	*	ST	ST	ST	ST	ST	ST
	L170 039	bronce	*	ST	ST	ST	ST	ST	ST
	L170 040	gris claro	*	ST	ST	ST	ST	ST	ST
	L170 097	oxyde claro	*	ST	ST	ST	ST	ST	ST
	L170 118	acero azul	*	ST	ST	ST	ST	ST	ST

Vitrinas

Solo están disponibles las vitrinas universales



**N
E
W**

	CEMENTO	Color de frente	Carcasa	Costado visto	W 19	W 100	XW5/ XW6	Zócalos	Estantes
	N170 205	amber	*	ST	ST	-	ST	ST	ST
	N170 096	basalt oscuro	*	ST	ST	-	ST	ST	ST
	N170 022	negro	*	ST	ST	-	ST	ST	ST
	N170 039	bronce	*	ST	ST	-	ST	ST	ST
	N170 040	gris claro	*	ST	ST	-	ST	ST	ST
	N170 097	oxyde claro	*	ST	ST	-	ST	ST	ST
	N170 118	acero azul	*	ST	ST	-	ST	ST	ST

Vitrinas

R Vitrina con marco cuadrado,
L Vitrina con montantes verticales



Melamina texturizada simulando cemento,
canteado de 1 mm a cuatro cantos.

Configuración de posiciones de tirador CEMENTO

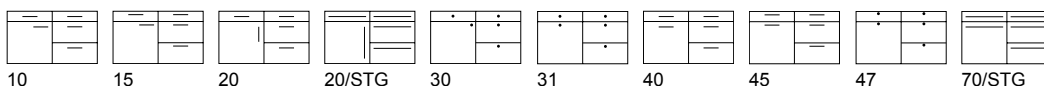

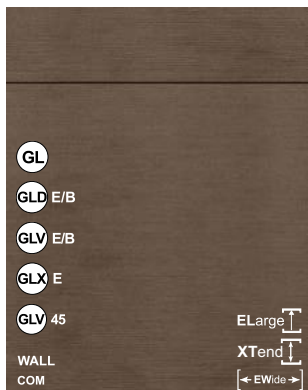

**P
R
E
M
I
U
M**

Vitrinas
G/GA/GM/R Vitrina con marco cuadrado,
L Vitrina con montantes verticales

METALL H	COM	Color de frente	Carcasa	Costado visto	W 19	W 100	XW5/XW6	Zócalos	Estantes
P233 022	P333 022	negro, H	KS	ST	ST	ST	ST	ST	ST
P233 196	P333 196	marrón, H	*	ST	ST	ST	ST	ST	ST
P233 060	P333 060	acero oscuro, H	*	ST	ST	ST	ST	ST	ST
P233 059	P333 059	umbra claro, H	*	ST	ST	ST	ST	ST	ST

METALL V	COM	Color de frente	Carcasa	Costado visto	W 19	W 100	XW5/XW6	Zócalos	Estantes
P234 022	P334 022	negro, V	KS	ST	ST	ST	ST	ST	ST
P234 196	P334 196	marrón, V	*	ST	ST	ST	ST	ST	ST
P234 060	P334 060	acero oscuro, V	*	ST	ST	ST	ST	ST	ST
P234 059	P334 059	umbra claro, V	*	ST	ST	ST	ST	ST	ST



**L
I
T
E**

Vitrinas
Solo están disponibles las vitrinas universales

METALL H	Color de frente	Carcasa	Costado visto	W 19	W 100	XW5/XW6	Zócalos	Estantes
L233 022	negro, H	*	ST	ST	ST	ST	ST	ST
L233 196	marrón, H	*	ST	ST	ST	ST	ST	ST
L233 060	acero oscuro, H	*	ST	ST	ST	ST	ST	ST
L233 059	umbra claro, H	*	ST	ST	ST	ST	ST	ST

METALL V	Color de frente	Carcasa	Costado visto	W 19	W 100	XW5/XW6	Zócalos	Estantes
L234 022	negro, V	*	ST	ST	ST	ST	ST	ST
L234 196	marrón, V	*	ST	ST	ST	ST	ST	ST
L234 060	acero oscuro, V	*	ST	ST	ST	ST	ST	ST
L234 059	umbra claro, V	*	ST	ST	ST	ST	ST	ST



Lámina de melamina gruesa con textura **horizontal/vertical** y efecto metálico, canteado de PP a cuatro cantos.

Configuración de posiciones de tirador METALL H+V

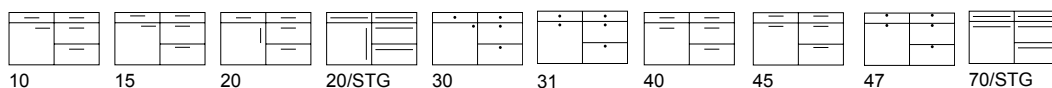



		Color de frente	Carcasa	Costado visto	W 19	W50+100	XW5/ XW6	Zócalos	Estantes
P275	402	STYLE	Extrem black	KS	XTR	XTR	XTR	XTR	KS
					STXTR				
		Color de frente	Carcasa	Costado visto	W 19	W50+100	XW5/ XW6	Zócalos	Estantes
P355	404	STYLE	Fenix black	KS	SMF	SMF	SMF	SMF	KS
					STSMF				

Vitrinas

Solo están disponibles las vitrinas universales



STYLE EXTREM
black



STYLE FENIX
black

Los frentes tienen un canteado simulando madera (Compact-Style).

Los costados **W19** se pueden elegir de entre la opción de canto en el color de frente **XTR/SMF** o la opción con **canto Style (STY)**, (ver tabla).

Configuración de posiciones de tirador STYLE

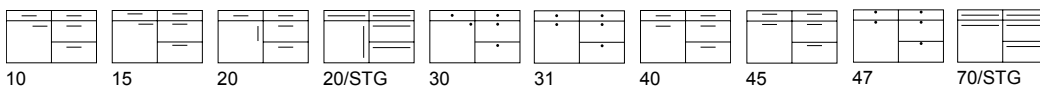

**Acabados
mates**





PREMIUM

FEELWOOD H COM		Color de frente	Carcasa	Costado visto	W 19	W 100	XW5/ XW6	Zócalos	Estantes
P118 422	P277 422	black, H	KS	ST	ST	ST	ST	ST	ST

FEELWOOD V COM		Color de frente	Carcasa	Costado visto	W 19	W 100	XW5/ XW6	Zócalos	Estantes
P119 422	P278 422	black, V	KS	ST	ST	ST	ST	ST	ST

Vitrinas

G/GA/GM/R Vitrina con marco cuadrado,
L Vitrina con montantes verticales



LITE

FEELWOOD H		Color de frente	Carcasa	Costado visto	W 19	W 100	XW5/ XW6	Zócalos	Estantes
L118 422		black, H	*	ST	ST	ST	ST	ST	ST

FEELWOOD V		Color de frente	Carcasa	Costado visto	W 19	W 100	XW5/ XW6	Zócalos	Estantes
L119 422		black, V	*	ST	ST	ST	ST	ST	ST

Vitrinas

Solo están disponibles las vitrinas universales



black, H



black, V

Frente: Melamina Feelwood con superficie de lacado UV y acabado antihuellas; con veteado horizontal/vertical, canteado igual a frente, y parte trasera igual pero sin acabado antihuellas

Configuración de posiciones de tirador FEELWOOD H+V

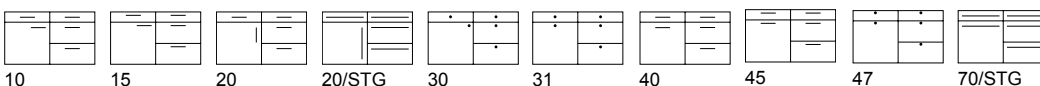

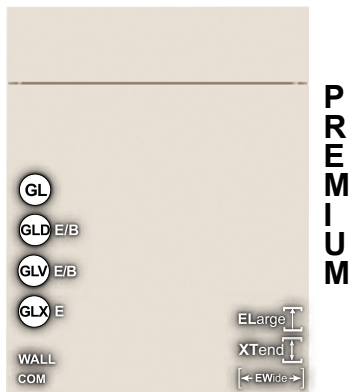

Vitrinas
L Vitrina con montantes verticales

FROST	COM	Color de frente	Carcasa	Costado visto	W 19	W50+100	XW5/XW6	Zócalos	Estantes
P111 006	P221 006	bianco	KS	SM	SM	SM	SM	SM	SM
P111 090	P221 090	magnolia	KS	SM	SM	SM	SM	SM	SM
P111 007	P221 007	optiwhite	KS	SM	SM	SM	SM	SM	SM
P111 244	P221 244	shell	KS	SM	SM	SM	SM	SM	SM

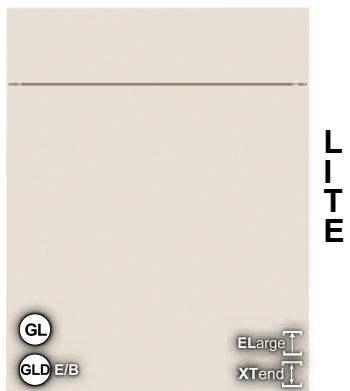

Vitrinas
Solo están disponibles las vitrinas universales

FROST	Color de frente	Carcasa	Costado visto	W 19	W50+100	XW5/XW6	Zócalos	Estantes
L111 006	bianco	KS	SM	SM	SM	SM	SM	SM
L111 090	magnolia	*	SM	SM	SM	SM	SM	SM
L111 007	optiwhite	*	SM	SM	SM	SM	SM	SM
L111 244	shell	*	SM	SM	SM	SM	SM	SM



Vitrinas
L Vitrina con montantes verticales

FROST	Color de frente	Carcasa	Costado visto	W 19	W50+100	XW5/XW6	Zócalos	Estantes
N111 006	bianco	KS	SM	SM	-	SM	SM	SM
N111 090	magnolia	*	SM	SM	-	SM	SM	SM
N111 007	optiwhite	*	SM	SM	-	SM	SM	SM
N111 244	shell	*	SM	SM	-	SM	SM	SM



Estratificado mate, canteado sin juntas a cuatro cantos.

Configuración de posiciones de tirador FROST

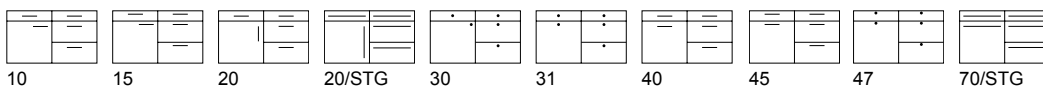

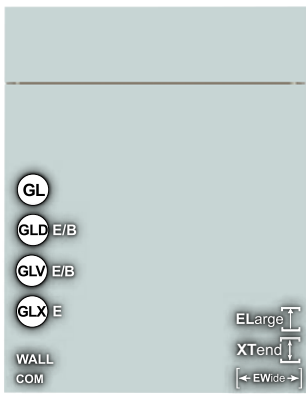

PREMIUM

OPACO	COM	Color de frente	Carcasa	Costado visto	W 19	W50+100	XW5/ XW6	Zócalos	Estantes
P232 250	P332 250	aqua	*	UVM	UVM	-	UVM	UVM	-
P232 006	P332 006	bianco	KS	UVM	UVM	-	UVM	UVM	KS
P232 022	P332 022	negro	KS	UVM	UVM	-	UVM	UVM	KS
P232 063	P332 063	carbón	KS	UVM	UVM	-	UVM	UVM	KS
P232 129	P332 129	acabado dorado	*	UVM	UVM	-	UVM	UVM	-
P232 123	P332 123	delfin	KS	UVM	UVM	-	UVM	UVM	KS
P232 014	P332 014	fango	-	UVM	UVM	-	UVM	UVM	KS
P232 024	P332 024	cachemir	KS	UVM	UVM	-	UVM	UVM	KS
P232 064	P332 064	grava	KS	UVM	UVM	-	UVM	UVM	KS
P232 251	P332 251	laguna	*	UVM	UVM	-	UVM	UVM	-
P232 111	P332 111	océano	*	UVM	UVM	-	UVM	UVM	-
P232 128	P332 128	pizarra	KS	UVM	UVM	-	UVM	UVM	KS
P232 101	P332 101	snow	KS	UVM	UVM	-	UVM	UVM	KS
P232 109	P332 109	acero dorado-marrón	*	UVM	UVM	-	UVM	UVM	-

Vitrinas

L Vitrina con montantes verticales

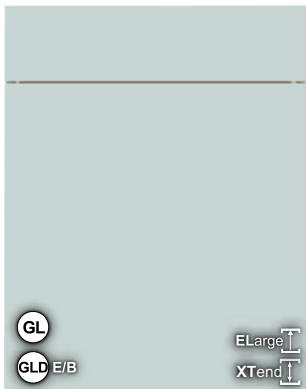

LITE

OPACO	Color de frente	Carcasa	Costado visto	W 19	W50+100	XW5/ XW6	Zócalos	Estantes
L232 250	aqua	*	UVM	UVM	-	UVM	UVM	-
L232 006	bianco	KS	UVM	UVM	-	UVM	UVM	KS
L232 022	negro	*	UVM	UVM	-	UVM	UVM	KS
L232 063	carbón	KS	UVM	UVM	-	UVM	UVM	KS
L232 129	acabado dorado	*	UVM	UVM	-	UVM	UVM	-
L232 123	delfin	KS	UVM	UVM	-	UVM	UVM	KS
L232 014	fango	*	UVM	UVM	-	UVM	UVM	KS
L232 024	cachemir	*	UVM	UVM	-	UVM	UVM	KS
L232 064	grava	*	UVM	UVM	-	UVM	UVM	KS
L232 251	laguna	*	UVM	UVM	-	UVM	UVM	-
L232 111	océano	*	UVM	UVM	-	UVM	UVM	-
L232 128	pizarra	KS	UVM	UVM	-	UVM	UVM	KS
L232 101	snow	*	UVM	UVM	-	UVM	UVM	KS
L232 109	acero dorado-marrón	*	UVM	UVM	-	UVM	UVM	-

Vitrinas

Solo están disponibles las vitrinas universales



aqua bianco negro carbón acabado dorado delfin fango



cachemir grava laguna océano pizarra snow acero dorado-marrón

Lacado mate UV acabado seda ultramate antihuellas, 1,0 mm canteado sin juntas a cuatro cantos, **Atención!** los costados WW 19 mm disponen de una sola cara del acabado lacado UV, el reverso es en el mismo color pero no lacado

Configuración de posiciones de tirador OPACO

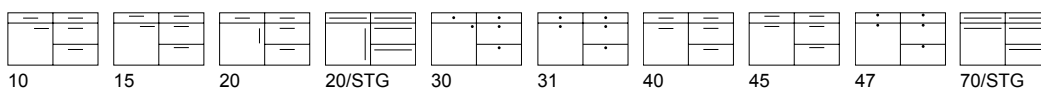

EXTREM

COM

Estratificado mate

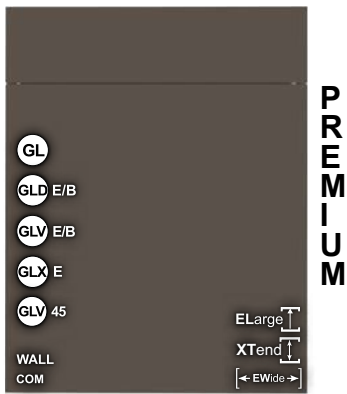

EXTREM	COM	Color de frente	Carcasa	Costado visto	W 19	W50+100	XW5/XW6	Zócalos	Estantes
P385 022	P485 022	negro	KS	XTR	XTR	XTR	XTR	XTR	KS
P385 017	P485 017	grafito	KS	XTR	XTR	XTR	XTR	XTR	KS
P385 007	P485 007	optiwhite	KS	XTR	XTR	XTR	XTR	XTR	KS
P385 243	P485 243	orion	KS	XTR	XTR	XTR	XTR	XTR	KS
P385 244	P485 244	shell	KS	XTR	XTR	XTR	XTR	XTR	KS
P385 101	P485 101	snow	KS	XTR	XTR	XTR	XTR	XTR	KS

Vitrinas
L Vitrina con montantes verticales

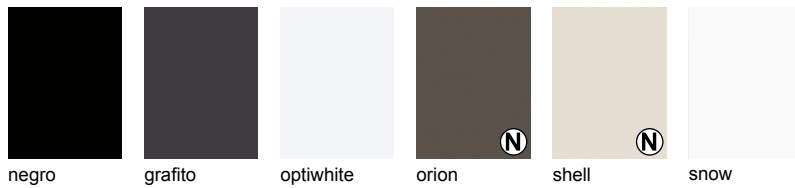

Estratificado extra mate, acabado seda ultramate antihuellas. 1,0 mm canteado sin juntas a cuatro cantos.

Configuración de posiciones de tirador EXTREM

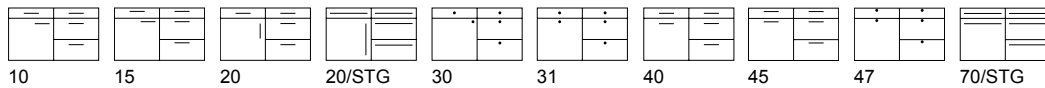

URBAN

COM

Estratificado imitando cemento

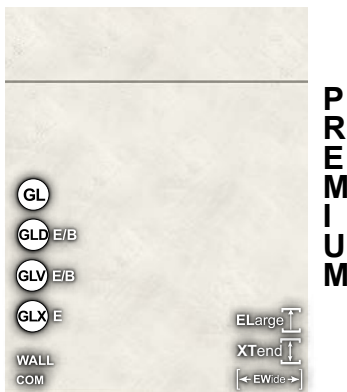

URBAN	COM	Color de frente	Carcasa	Costado visto	W 19	W50+100	XW5/XW6	Zócalos	Estantes
P265 062	P365 062	cemento blanco	*	SZ	SZ	SZ	SZ	SZ	-

Vitrinas
L Vitrina con montantes verticales

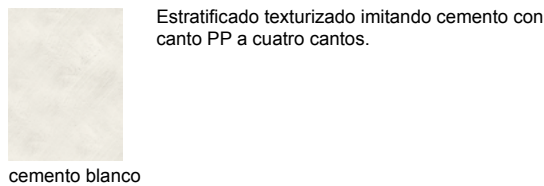

Estratificado texturizado imitando cemento con canto PP a cuatro cantos.

Configuración de posiciones de tirador URBAN

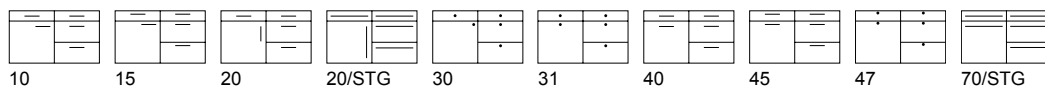

Acabados en melamina

Acabados mates

Acabados brillantes

Acabados polilaminados

Wood Range + Wood Specials

Tiradores, encimeras, tablas de acabados, modelos descatalogados

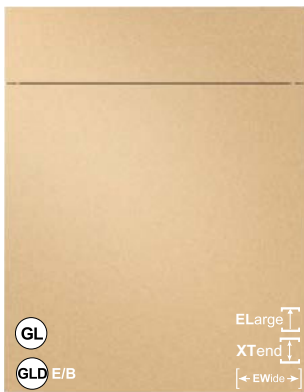

POMP	Color de frente	Carcasa	Costado visto	W 19	W50+100	XW5/ XW6	Zócalos	Estantes
P476 410	cobre	*	ML	ML*	-	-	ML	-
P476 413	cobre cepillado	*	ML	ML*	-	-	ML	-
P476 411	oro	*	ML	ML*	-	-	ML	-
P476 412	oro cepillado	*	ML	ML*	-	-	ML	-

* ¡Los costados solo tienen el acabado metalizado en una cara, la otra siempre es color antracita!

Vitrinas

Solo están disponibles las vitrinas universales



Frente: Núcleo de MDF (DM) con una hoja metálica adherida, y sobre esta una superficie de lacado mate transparente. La hoja contiene metales reales. Los cantos son de ABS. La parte interior siempre es color antracita, con lo que se recomienda el uso de la carcasa color grafito.

Configuración de posiciones de tirador POMP

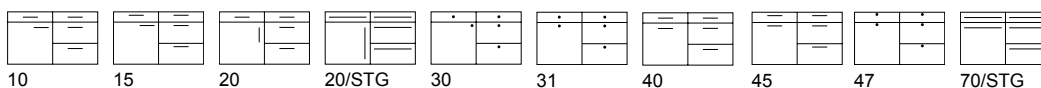

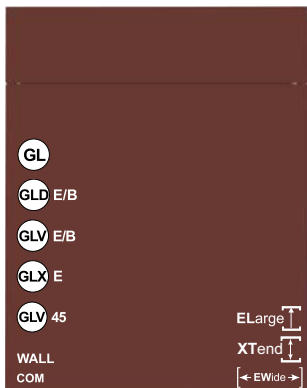

P R E M I U M

FENIX	COM	Color de frente	Carcasa	Costado visto	W 19	W 50	XW5/XW6	Zócalos	Estantes
P310 006	P510 006	bianco	KS	SM/SMF	SM/SMF	SM/SMF	SMF	SM/SMF	SM
P310 022	P510 022	negro	KS	SMF	SMF	SMF	SMF	SMF	-
P310 134	P510 134	bromo	*	SMF	SMF	SMF	SMF	SMF	-
P310 135	P510 135	cacao	*	SMF	SMF	SMF	SMF	SMF	-
P310 091	P510 091	gris claro	*	SMF	SMF	SMF	SMF	SMF	-
P310 034	P510 034	blanco kos	KS	SM/SMF	SM/SMF	SM/SMF	SMF	SM/SMF	SM
P310 044	P510 044	londra	*	SMF	SMF	SMF	SMF	SMF	-
P310 110	P510 110	azul noche	*	SMF	SMF	SMF	SMF	SMF	-
P310 007	P510 007	optiwhite	KS	SM/SMF	SM/SMF	SM/SMF	SMF	SM/SMF	SM
P310 136	P510 136	rosso	*	SMF	SMF	SMF	SMF	SMF	-
P310 137	P510 137	verde	*	SMF	SMF	SMF	SMF	SMF	-

PROPIEDADES FENIX

Resistente a la luz. Resistente a productos de limpieza. Resistente a productos de base ácida. Superficie con nanotecnología. Óptica ultramate con tacto suave. Antihuellas. Antibacteriano. Antiestático. Resistente a la abrasión y las ralladuras. Se pueden reparar los daños superficiales con una goma o una plancha a 80°.



Estratificado mate con propiedades especiales, canteado sin juntas a cuatro cantos.

Configuración de posiciones de tirador FENIX

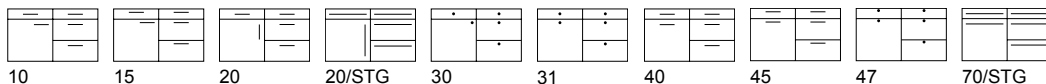

ART-GLAS MATT

Acrílico mate



P R E M I U M

ART-GLAS MATT	Color de frente	Carcasa	Costado visto	W 19	W50+100	XW5/XW6	Zócalos	Estantes
P383 179	aureo	KS grava	ACM	ACM*	-	ACM	ACM	KS grava
P383 006	bianco	KS bianco	ACM	ACM*	-	ACM	ACM	KS bianco
P383 022	negro	KS negro	ACM	ACM*	-	ACM	ACM	KS negro
P383 017	grafito	KS grafito	ACM	ACM*	-	ACM	ACM	KS grafito
P383 181	luminoso	*	ACM	ACM*	-	ACM	ACM	*
P383 180	opale	*	ACM	ACM*	-	ACM	ACM	*
P383 101	snow	KS snow	ACM	ACM*	-	ACM	ACM	KS snow
P383 188	terricio	*	ACM	ACM*	-	ACM	ACM	-
P383 187	titanio	*	ACM	ACM*	-	ACM	ACM	-

PROPIEDADES DEL EFECTO VIDRIO MATE:

- superficie súper mate
- 50% más ligera
- 10 veces más resistente a los impactos que el vidrio real
- alta resistencia al rayado
- fácil limpieza gracias a nano-propiedades
- certificado TÜV
- perforación posible

* ¡los costados están disponibles con un solo lado acrílico, el dorso es laminado del mismo color!

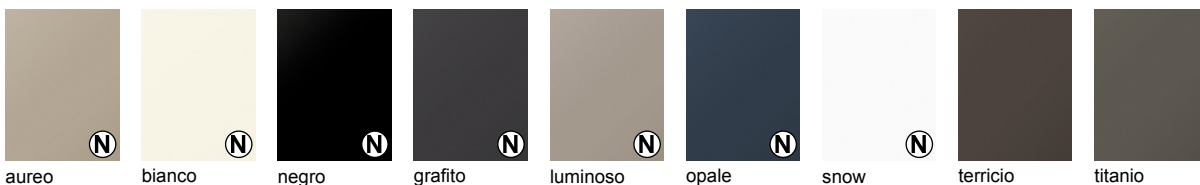

Frontal de acrílico efecto vidrio de alta calidad con borde biselado mate

Configuración de posiciones de tirador ART-GLAS MATT

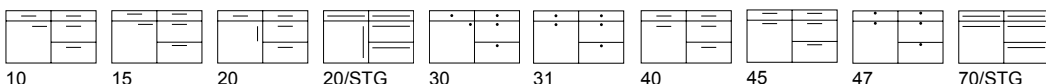

EFFECTO

COM

Lacado mate metálico



EFFECTO	COM	Color de frente	Carcasa	Costado visto	W 19	W50+100	XW5/ XW6	Zócalos	Estantes
P506 182	P606 182	bronce oscuro	*	LM	LM	LM	LM	LM	-
P506 186	P606 186	bronce claro	*	LM	LM	LM	LM	LM	-
P506 183	P606 183	silver	*	LM	LM	LM	LM	LM	-
P506 184	P606 184	titan	*	LM	LM	LM	LM	LM	-

CADA FRENTE ES ÚNICO

La capa superficial consiste en un lacado especial metalizado, realizado en su mayoría de manera manual. Los diferentes tonos y veteados de cada pieza son aleatorios y ese es el efecto deseado. Únicamente mediante este proceso se consigue dotar al mobiliario de este aspecto único.

Vitrinas

L Vitrina con montantes verticales



Efecto metalizado con canteados en el mismo lacado radio de 2 mm. El reverso viene en un color igual al lacado.

Configuración de posiciones de tirador

EFFECTO

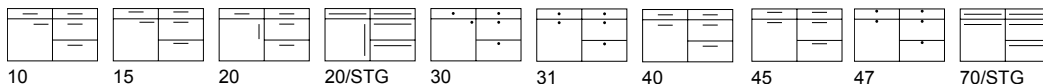

CONCRETE

Superficie de cemento real

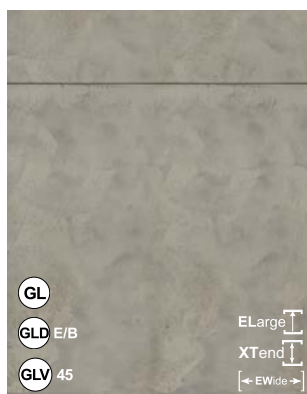

CONCRETE	Color de frente	Carcasa	Costado visto	W 19	W50+100	XW5/ XW6	Zócalos	Estantes
P522 161	claro	*	BT	BT	BT	BT	BT	-
P522 163	oscuro	*	BT	BT	BT	BT	BT	-
P522 162	medio	*	BT	BT	BT	BT	BT	-
P522 160	superclaro	*	BT	BT	BT	BT	BT	-

Vitrinas

G/GA/GM/R Vitrina con marco cuadrado,
L Vitrina con montantes verticales



DM (MDF) revestido de cemento real, reverso en el mismo color

Configuración de posiciones de tirador

CONCRETE

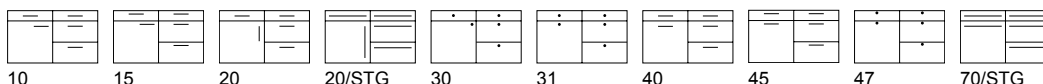

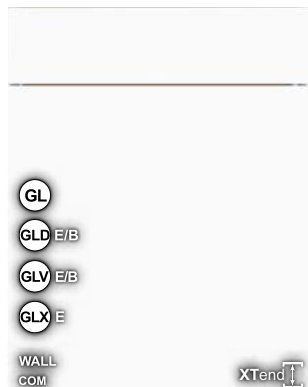

**P
R
E
M
I
U
M**

Vitrinas
L Vitrina con montantes verticales

LUNA R2	COM	Color de frente	Carcasa	Costado visto	W 19	W 50	XW5/ XW6	Zócalos	Estantes
P219 101	P319 101	snow	KS	UM/ML	UM/ML	UM/ML	ML	UM/ML	UM
LUNA R2 RAL COM	Color de frente	Carcasa	Costado visto	W 19	W 50	XW5/ XW6	Zócalos	Estantes	
P293 000	P501 000	RAL, Sikkens, NCS	*	ML	ML	ML	ML	ML	-



**L
I
T
E**

Vitrinas
Solo están disponibles las vitrinas universales

LUNA R2	Color de frente	Carcasa	Costado visto	W 19	W 50	XW5/ XW6	Zócalos	Estantes
L219 101	snow	*	UM/ML	UM/ML	UM/ML	ML	UM/ML	UM

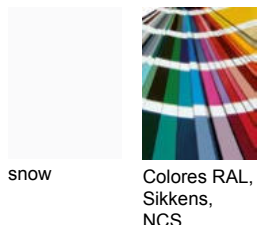

Colores RAL, Sikkens, NCS

La posibilidad de lacado en carta de color solo está disponible para cocinas completas. En pedidos pequeños hasta 10 puertas, se valorará bajo demanda y con suplemento. No disponibles colores metálicos!

Se deben solicitar frentes y puertas RAL dentro de los siguientes 6 meses desde el pedido, a fin de evitar diferencias menores de color.

Lacado mate con radio de 2 mm.

XTend Puertas XTend (a medida), con canto inferior metálico

Configuración de posiciones de tirador

LUNA R2 + RAL

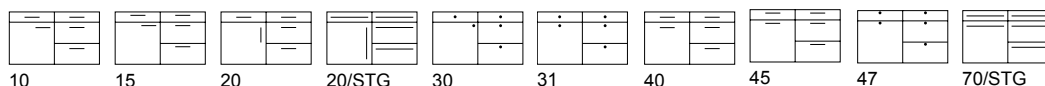

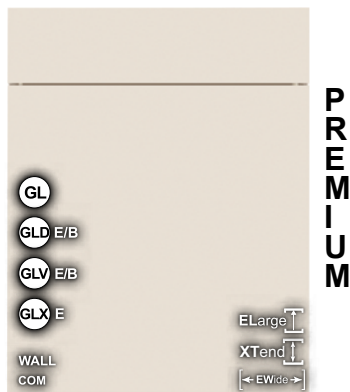

Vitrinas
 G/GA/GM/R Vitrina con marco cuadrado,
 L Vitrina con montantes verticales

LUNA MICRON	COM	Color de frente	Carcasa	Costado visto	W/WR 19	W 50	XW5/XW6	Zócalos	Estantes
P311 006	P471 006	bianco	KS	MLMi	MLMi	MLMi	MLMi	MLMi	KS
P311 022	P471 022	negro	KS	MLMi	MLMi	MLMi	MLMi	MLMi	KS
P311 063	P471 063	carbón	KS	MLMi	MLMi	MLMi	MLMi	MLMi	KS
P311 017	P471 017	grafito	KS	MLMi	MLMi	MLMi	MLMi	MLMi	KS
P311 024	P471 024	cachemir	KS	MLMi	MLMi	MLMi	MLMi	MLMi	KS
P311 064	P471 064	grava	KS	MLMi	MLMi	MLMi	MLMi	MLMi	KS
P311 044	P471 044	londra	*	MLMi	MLMi	MLMi	MLMi	MLMi	-
P311 208	P471 208	marone	*	MLMi	MLMi	MLMi	MLMi	MLMi	-
P311 110	P471 110	azul noche	*	MLMi	MLMi	MLMi	MLMi	MLMi	-
P311 112	P471 112	musgo	*	MLMi	MLMi	MLMi	MLMi	MLMi	-
P311 032	P471 032	oliva	*	MLMi	MLMi	MLMi	MLMi	MLMi	-
P311 243	P471 243	orion	KS	MLMi	MLMi	MLMi	MLMi	MLMi	KS
P311 209	P471 209	seta	*	MLMi	MLMi	MLMi	MLMi	MLMi	-
P311 244	P471 244	shell	KS	MLMi	MLMi	MLMi	MLMi	MLMi	KS
P311 101	P471 101	snow	KS	MLMi	MLMi	MLMi	MLMi	MLMi	KS
P311 113	P471 113	verde abeto	*	MLMi	MLMi	MLMi	MLMi	MLMi	-
P311 210	P471 210	urbano	*	MLMi	MLMi	MLMi	MLMi	MLMi	-
RAL									
P503 000		RAL, Sikkens, NCS	*	MLMi	MLMi	MLMi	MLMi	MLMi	-

LUNA Micron RAL COM no está disponible

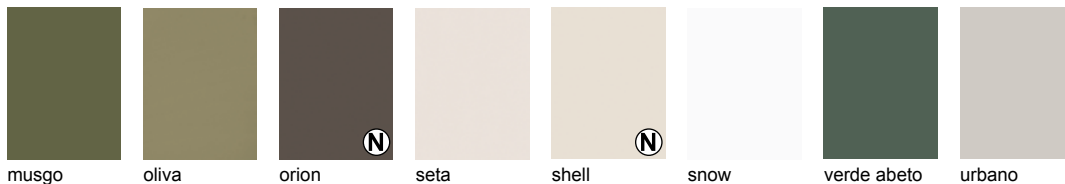
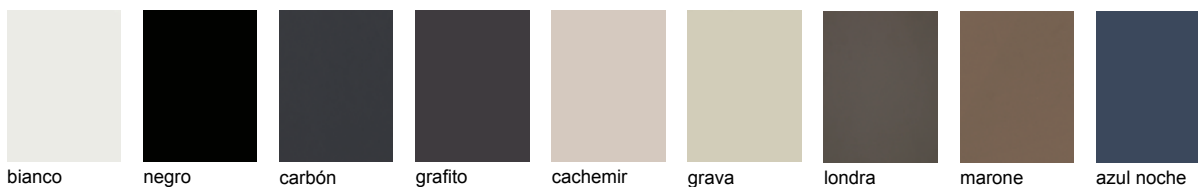

Laca estructurada Micron con radio de 2 mm.



Colores RAL, Sikkens, NCS

La posibilidad de lacado en carta de color solo está disponible para cocinas completas. En pedidos pequeños hasta 10 puertas, se valorará bajo demanda y con suplemento. No disponibles colores metálicos!

Se deben solicitar frentes y puertas RAL dentro de los siguientes 6 meses desde el pedido, a fin de evitar diferencias menores de color.

Configuración de posiciones de tirador

LUNA MICRON

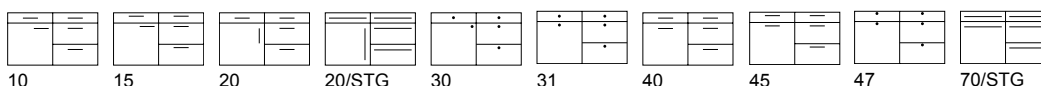

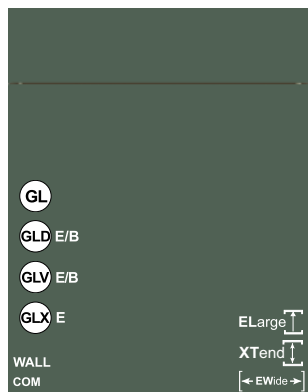

P R E M I U M

Vitrinas
G/GA/GM/R Vitrina con marco,
L vitrina con montantes verticales laterales

LUNA SOFT	COM	Color de frente	Carcasa	Costado visto	W/WR 19	W 50	XW5/XW6	Zócalos	Estantes
P340 006	P540 006	bianco	KS	MLSO	MLSO	MLSO	MLSO	MLSO	KS
P340 022	P540 022	negro	KS	MLSO	MLSO	MLSO	MLSO	MLSO	KS
P340 063	P540 063	carbón	KS	MLSO	MLSO	MLSO	MLSO	MLSO	KS
P340 017	P540 017	grafito	KS	MLSO	MLSO	MLSO	MLSO	MLSO	KS
P340 024	P540 024	cachemir	KS	MLSO	MLSO	MLSO	MLSO	MLSO	KS
P340 064	P540 064	grava	KS	MLSO	MLSO	MLSO	MLSO	MLSO	KS
P340 044	P540 044	londra	*	MLSO	MLSO	MLSO	MLSO	MLSO	-
P340 208	P540 208	marone	*	MLSO	MLSO	MLSO	MLSO	MLSO	-
P340 110	P540 110	azul noche	*	MLSO	MLSO	MLSO	MLSO	MLSO	-
P340 112	P540 112	musgo	*	MLSO	MLSO	MLSO	MLSO	MLSO	-
P340 032	P540 032	oliva	*	MLSO	MLSO	MLSO	MLSO	MLSO	-
P340 243	P540 243	orion	KS	MLSO	MLSO	MLSO	MLSO	MLSO	KS
P340 209	P540 209	seta	*	MLSO	MLSO	MLSO	MLSO	MLSO	-
P340 244	P540 244	shell	KS	MLSO	MLSO	MLSO	MLSO	MLSO	KS
P340 101	P540 101	snow	KS	MLSO	MLSO	MLSO	MLSO	MLSO	KS
P340 113	P540 113	verde abeto	*	MLSO	MLSO	MLSO	MLSO	MLSO	-
P340 210	P540 210	urbano	*	MLSO	MLSO	MLSO	MLSO	MLSO	-

Propiedades de la laca antihuellas:

- look ultramate
- sensación agradable, suave y aterciopelada
- antireflectante
- absolutamente ninguna huella queda visible

Anotación:

- La laca tiene solo cierta resistencia antichoque

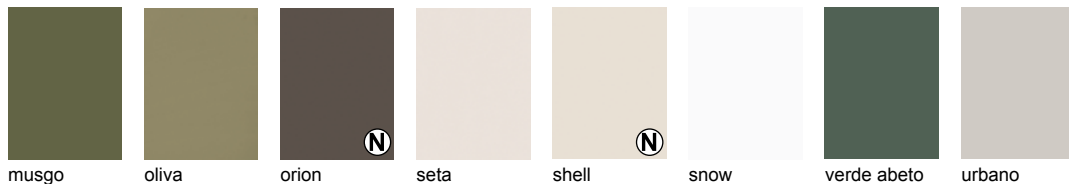
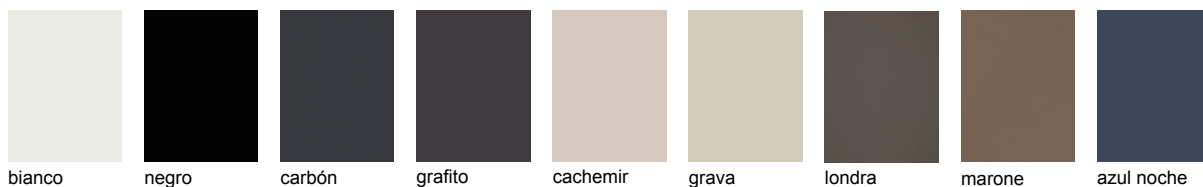

Frente: Lacado mate sobre MDF anti-huellas, radio 2 mm

Configuración de posiciones de tirador LUNA SOFT

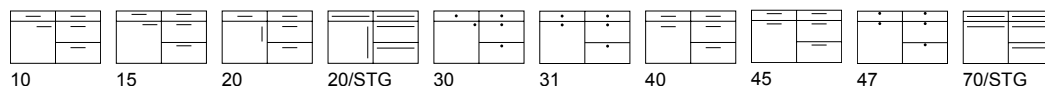

Acabados en melamina

Acabados mates

Acabados brillantes

Acabados polilaminados

Wood Range + Wood Specials

Tiradores, encimeras, tablas de acabados, modelos descatalogados



PREMIUM

Vitrinas

R Vitrina con marco
Puerta con marco de una pieza hasta
máx.1690 mm de altura

INSPIRATION SOFT	Color de frente	Carcasa	Costado visto	W/WR 19	W 50	KL/LL	Zócalos	Estantes
P423 006	bianco	KS	MLSO	MLSO	MLSO	-	MLSO	KS
P423 022	negro	KS	MLSO	MLSO	MLSO	-	MLSO	KS
P423 063	carbón	KS	MLSO	MLSO	MLSO	-	MLSO	KS
P423 017	grafito	KS	MLSO	MLSO	MLSO	-	MLSO	KS
P423 024	cachemir	KS	MLSO	MLSO	MLSO	-	MLSO	KS
P423 064	grava	KS	MLSO	MLSO	MLSO	-	MLSO	KS
P423 044	londra	*	MLSO	MLSO	MLSO	-	MLSO	-
P423 208	marone	*	MLSO	MLSO	MLSO	-	MLSO	-
P423 110	azul noche	*	MLSO	MLSO	MLSO	-	MLSO	-
P423 112	musgo	*	MLSO	MLSO	MLSO	-	MLSO	-
P423 032	oliva	*	MLSO	MLSO	MLSO	-	MLSO	-
P423 243	orion	KS	MLSO	MLSO	MLSO	-	MLSO	KS
P423 209	seta	*	MLSO	MLSO	MLSO	-	MLSO	-
P423 244	shell	KS	MLSO	MLSO	MLSO	-	MLSO	KS
P423 101	snow	KS	MLSO	MLSO	MLSO	-	MLSO	KS
P423 113	verde abeto	*	MLSO	MLSO	MLSO	-	MLSO	-
P423 210	urbano	*	MLSO	MLSO	MLSO	-	MLSO	-

Propiedades de la laca antihuellas:

- look ultramate
- sensación agradable, suave y aterciopelada
- antireflectante
- absolutamente ninguna huella queda visible

Anotación:

- La laca tiene solo cierta resistencia antichoque
- Los costados laterales con relieve solo están disponibles en versión lisa, por favor, solicitar el acabado deseado de los programas Luna

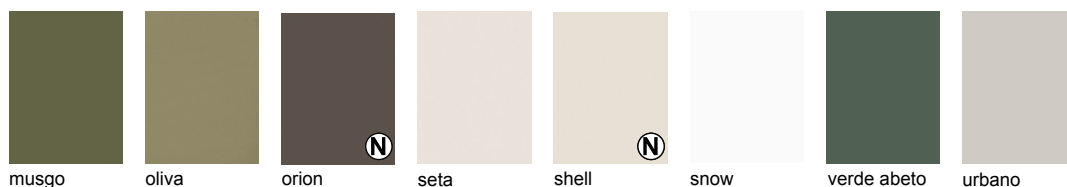

Frente: Lacado mate sobre MDF anti-huellas, con mecanizado de 45° y radio 2 mm

Configuración de posiciones de tirador INSPIRATION SOFT

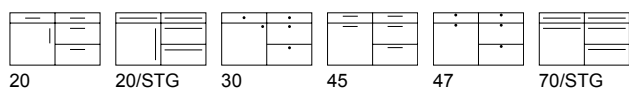



Vitrinas
R Vitrina con marco
Puerta con marco de una pieza hasta
máx. 1690 mm de altura

ELEGANCE SOFT	Color de frente	Carcasa	Costado visto	W/WR 19	W 50	KL/LL	Zócalos	Estantes
P424 006	bianco	KS	MLSO	MLSO	MLSO	-	MLSO	KS
P424 022	negro	KS	MLSO	MLSO	MLSO	-	MLSO	KS
P424 063	carbón	KS	MLSO	MLSO	MLSO	-	MLSO	KS
P424 017	grafito	KS	MLSO	MLSO	MLSO	-	MLSO	KS
P424 024	cachemir	KS	MLSO	MLSO	MLSO	-	MLSO	KS
P424 064	grava	KS	MLSO	MLSO	MLSO	-	MLSO	KS
P424 044	londra	*	MLSO	MLSO	MLSO	-	MLSO	-
P424 208	marone	*	MLSO	MLSO	MLSO	-	MLSO	-
P424 110	azul noche	*	MLSO	MLSO	MLSO	-	MLSO	-
P424 112	musgo	*	MLSO	MLSO	MLSO	-	MLSO	-
P424 032	oliva	*	MLSO	MLSO	MLSO	-	MLSO	-
P424 243	orion	KS	MLSO	MLSO	MLSO	-	MLSO	KS
P424 209	seta	*	MLSO	MLSO	MLSO	-	MLSO	-
P424 244	shell	KS	MLSO	MLSO	MLSO	-	MLSO	KS
P424 101	snow	KS	MLSO	MLSO	MLSO	-	MLSO	KS
P424 113	verde abeto	*	MLSO	MLSO	MLSO	-	MLSO	-
P424 210	urbano	*	MLSO	MLSO	MLSO	-	MLSO	-

Propiedades de la laca antihuellas:

- look ultramate
- sensación agradable, suave y aterciopelada
- antireflectante
- absolutamente ninguna huella queda visible

Anotación:

- La laca tiene solo cierta resistencia antichoque
- Los costados laterales con relieve solo están disponibles en versión lisa, por favor, solicitar el acabado deseado de los programas Luna

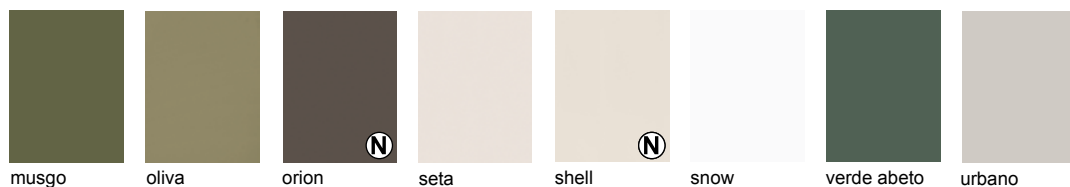
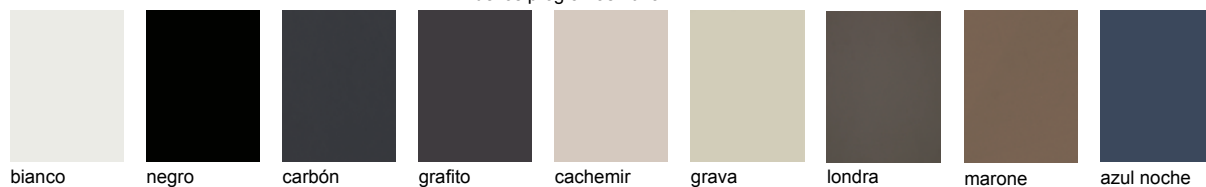

Frente: Lacado mate **anti-huellas** a doble marco sobre MDF con radio de 2 mm

Configuración de posiciones de tirador ELEGANCE SOFT

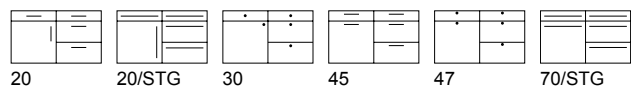



P
R
E
M
I
U
M

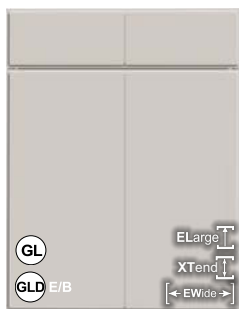

UNO
con una ranura vertical
en el centro



R15
con ranuras verticales
cada 150 mm
Anotación
Las siguientes anchuras
tienen distancia entre
ranuras especial:
40+80 cm = 132 mm
50+100 cm = 165 mm



R20
con ranuras verticales
cada 200 mm
Anotación
Las siguientes anchuras
tienen distancia entre
ranuras especial:
30 cm = 148 mm
45+90 cm = 223 mm
50 cm = 248 mm

Vitrina

Vitrina R marco R,
L Vitrina con montantes verticales

Propiedades de la laca antihuellas:

- look ultramate
- sensación agradable, suave y aterciopelada
- antireflectante
- absolutamente ninguna huella queda visible

Anotación:

- La laca tiene solo cierta resistencia antichoque
- Los costados laterales con relieve solo están disponibles en versión lisa, por favor, solicitar el acabado deseado de los programas Luna

				Costado							
ZERO	UNO	R15	R20	Color de frente	Carcasa	visto	W/WR 19	W 50	KL/LL	Zócalos	Estantes
P312 006	P313 006	P314 006	P315 006	bianco	KS	MLSO	MLSO	MLSO	-	MLSO	KS
P312 022	P313 022	P314 022	P315 022	negro	KS	MLSO	MLSO	MLSO	-	MLSO	KS
P312 063	P313 063	P314 063	P315 063	carbón	KS	MLSO	MLSO	MLSO	-	MLSO	KS
P312 017	P313 017	P314 017	P315 017	grafito	KS	MLSO	MLSO	MLSO	-	MLSO	KS
P312 024	P313 024	P314 024	P315 024	cachemir	KS	MLSO	MLSO	MLSO	-	MLSO	KS
P312 064	P313 064	P314 064	P315 064	grava	KS	MLSO	MLSO	MLSO	-	MLSO	KS
P312 044	P313 044	P314 044	P315 044	londra	*	MLSO	MLSO	MLSO	-	MLSO	-
P312 208	P313 208	P314 208	P315 208	marone	*	MLSO	MLSO	MLSO	-	MLSO	-
P312 110	P313 110	P314 110	P315 110	azul noche	*	MLSO	MLSO	MLSO	-	MLSO	-
P312 112	P313 112	P314 112	P315 112	musgo	*	MLSO	MLSO	MLSO	-	MLSO	-
P312 032	P313 032	P314 032	P315 032	oliva	*	MLSO	MLSO	MLSO	-	MLSO	-
P312 243	P313 243	P314 243	P315 243	orion	KS	MLSO	MLSO	MLSO	-	MLSO	KS
P312 209	P313 209	P314 209	P315 209	seta	*	MLSO	MLSO	MLSO	-	MLSO	-
P312 244	P313 244	P314 244	P315 244	shell	KS	MLSO	MLSO	MLSO	-	MLSO	KS
P312 101	P313 101	P314 101	P315 101	snow	KS	MLSO	MLSO	MLSO	-	MLSO	KS
P312 113	P313 113	P314 113	P315 113	verde abeto	*	MLSO	MLSO	MLSO	-	MLSO	-
P312 210	P313 210	P314 210	P315 210	urbano	*	MLSO	MLSO	MLSO	-	MLSO	-

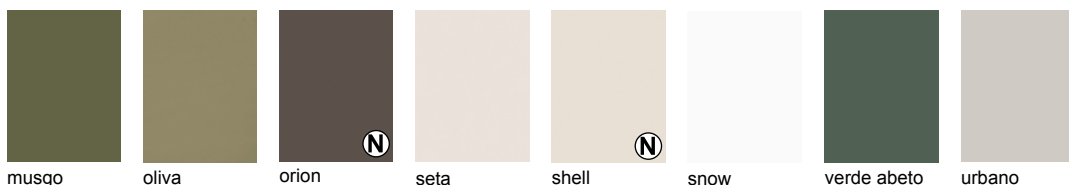
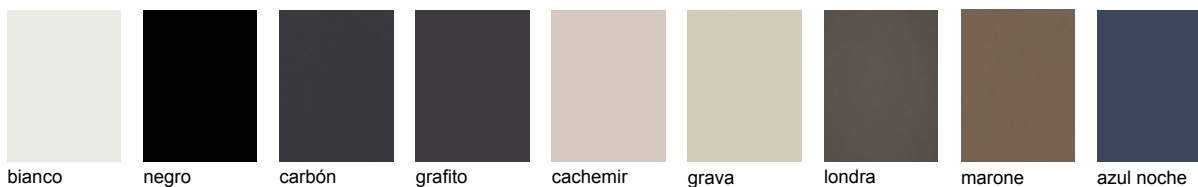

Frente: lacado mate antihuellas,
posibles acabados Uno / R15 / R20
con ranurado fino

Configuración de posiciones de tirador

MILA SOFT ZERO

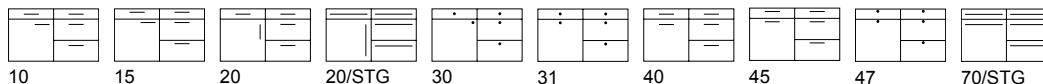

Configuración de posiciones de tirador

MILA SOFT UNO/R15/R20

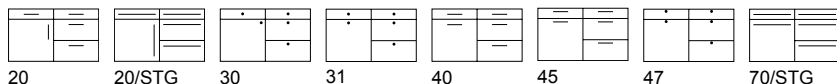



**Acabados
brillantes**

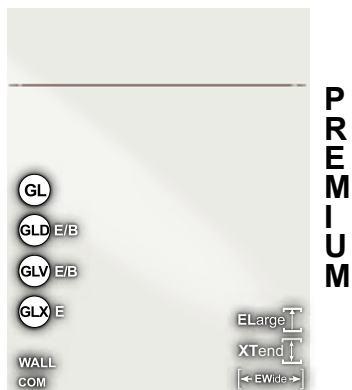

Vitrinas

L Vitrina con montantes verticales

SILK	COM	Color de frente	Carcasa	Costado visto	W 19	W50+100	XW5/ XW6	Zócalos	Estantes
P109 006	P215 006	bianco	KS	EG	EG	EG	EG	EG	EG
P109 007	P215 007	optiwhite	KS	EG	EG	EG	EG	EG	EG



Vitrinas

Solo están disponibles las vitrinas universales

SILK	Color de frente	Carcasa	Costado visto	W 19	W50+100	XW5/ XW6	Zócalos	Estantes
L109 006	bianco	KS	EG	EG	EG	EG	EG	EG
L109 007	optiwhite	*	EG	EG	EG	EG	EG	EG

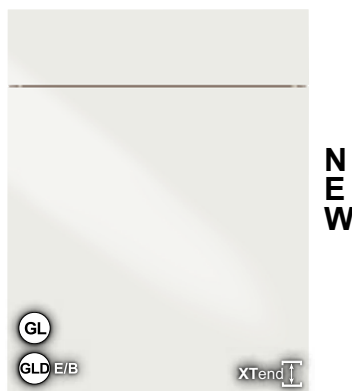

Vitrinas

L Vitrina con montantes verticales

SILK	Color de frente	Carcasa	Costado visto	W 19	W50+100	XW5/ XW6	Zócalos	Estantes
N109 006	bianco	KS	EG	EG	-	EG	EG	EG
N109 007	optiwhite	*	EG	EG	-	EG	EG	EG



Melamina brillante con canteado láser acabado brillante.

Configuración de posiciones de tirador

SILK

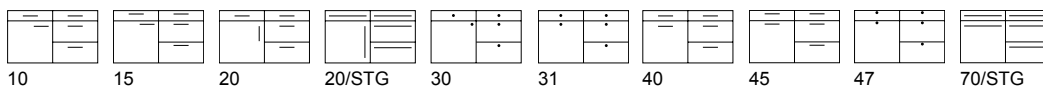

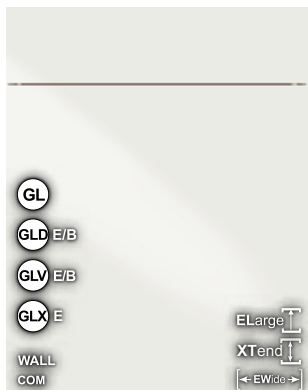

**P
R
E
M
I
U
M**

ESPRIT	COM	Color de frente	Carcasa	Costado visto	W 19	W50+100	XW5/XW6	Zócalos	Estantes
P112 006	P225 006	bianco	KS	SG	SG	SG	SG	SG	SG
P112 090	P225 090	magnolia	KS	SG	SG	SG	SG	SG	SG
P112 007	P225 007	optiwhite	KS	SG	SG	SG	SG	SG	SG
P112 101	P225 101	snow	KS	SG	SG	SG	SG	SG	SG

Vitrinas
L Vitrina con montantes verticales

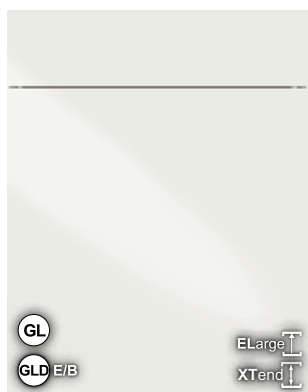

**L
I
T
E**

ESPRIT	Color de frente	Carcasa	Costado visto	W 19	W50+100	XW5/XW6	Zócalos	Estantes
L112 006	bianco	*	SG	SG	SG	SG	SG	SG
L112 090	magnolia	*	SG	SG	SG	SG	SG	SG
L112 007	optiwhite	*	SG	SG	SG	SG	SG	SG
L112 101	snow	*	SG	SG	SG	SG	SG	SG

Vitrinas
Solo están disponibles las vitrinas universales



**N
E
W**

ESPRIT	Color de frente	Carcasa	Costado visto	W 19	W50+100	XW5/XW6	Zócalos	Estantes
N112 006	bianco	KS	SG	SG	-	SG	SG	SG
N112 090	magnolia	*	SG	SG	-	SG	SG	SG
N112 007	optiwhite	*	SG	SG	-	SG	SG	SG
N112 101	snow	*	SG	SG	-	SG	SG	SG

Vitrinas
L Vitrina con montantes verticales



Estratificado alto brillo con canteado sin juntas a cuatro cantos.

Configuración de posiciones de tirador **ESPRIT**

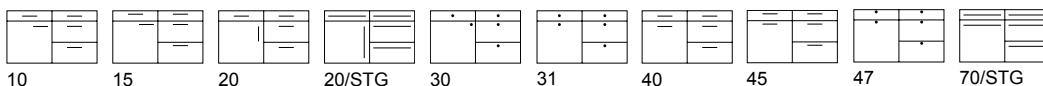



PREMIUM

	LUCE	COM	Color de frente	Carcasa	Costado visto	W 19	W50+100	XW5/XW6	Zócalos	Estantes
GLV 45	P218 006	P353 006	bianco	KS	UVHG/SG	UVHG/SG	SG	UVHG	SG	SG
	P218 095	P353 095	grigio	KS	UVHG	UVHG	-	UVHG	UVHG	-
	P218 024	P353 024	cachemir	KS	UVHG/EG	UVHG/EG	EG	UVHG	EG	EG
GLV 45	P218 007	P353 007	optiwhite	KS	UVHG/SG	UVHG/SG	SG	UVHG	SG	SG
GLV 45	P218 101	P353 101	snow	KS	UVHG/SG	UVHG/SG	SG	UVHG	SG	SG

Vitrinas

L Vitrina con montantes verticales

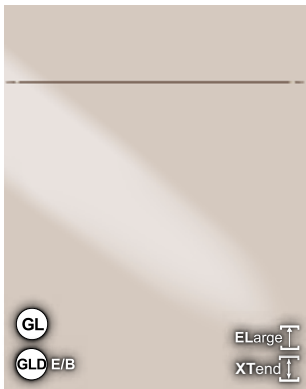

LITE

	LUCE	Color de frente	Carcasa	Costado visto	W 19	W50+100	XW5/XW6	Zócalos	Estantes
	L218 006	bianco	KS	UVHG/SG	UVHG/SG	SG	UVHG	SG	SG
	L218 095	grigio	*	UVHG	UVHG	-	UVHG	UVHG	-
	L218 024	cachemir	*	UVHG/EG	UVHG/EG	EG	UVHG	EG	EG
	L218 007	optiwhite	*	UVHG/SG	UVHG/SG	SG	UVHG	SG	SG
	L218 101	snow	*	UVHG/SG	UVHG/SG	SG	UVHG	SG	SG

Vitrinas

Solo están disponibles las vitrinas universales



NEW

	LUCE	Color de frente	Carcasa	Costado visto	W 19	W50+100	XW5/XW6	Zócalos	Estantes
	N218 006	bianco	KS	UVHG/SG	UVHG/SG	-	UVHG	SG	SG
	N218 095	grigio	*	UVHG	UVHG	-	UVHG	UVHG	-
	N218 024	cachemir	*	UVHG/EG	UVHG/EG	-	UVHG	EG	EG
	N218 007	optiwhite	*	UVHG/SG	UVHG/SG	-	UVHG	SG	SG
	N218 101	snow	*	UVHG/SG	UVHG/SG	-	UVHG	SG	SG

Vitrinas

L Vitrina con montantes verticales

Lacado alto brillo anti UV, canteado láser a cuatro cantos

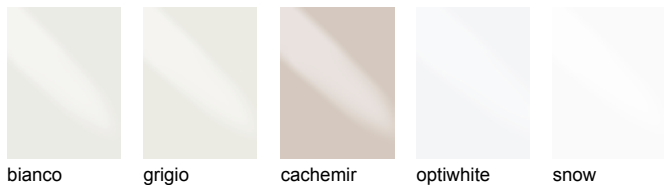

Configuración de posiciones de tirador LUCE

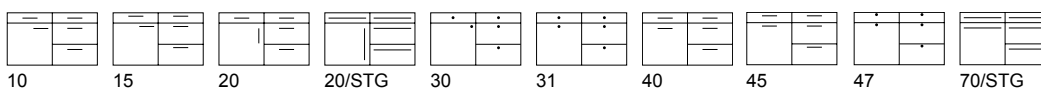

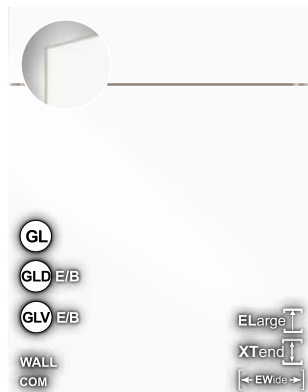

**P
R
E
M
I
U
M**

Vitrinas
Solo están disponibles las vitrinas universales

LUCE INF.	COM	Color de frente	Carcasa	Costado visto	W 19	W50+100	XW5/XW6	Zócalos	Estantes
P158 007	P258 007	optiwhite	*	UVHG/SG	UVHG/SG	SG	UVHG	SG	SG
P158 101	P258 101	snow	*	UVHG/SG	UVHG/SG	SG	UVHG	SG	SG



**L
I
T
E**

Vitrinas
Solo están disponibles las vitrinas universales

LUCE INF.	Color de frente	Carcasa	Costado visto	W 19	W50+100	XW5/XW6	Zócalos	Estantes
L158 007	optiwhite	*	UVHG/SG	UVHG/SG	SG	UVHG	SG	SG
L158 101	snow	*	UVHG/SG	UVHG/SG	SG	UVHG	SG	SG

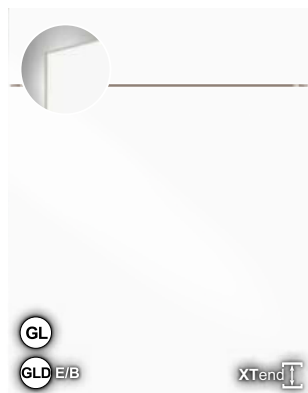

**N
E
W**

Vitrinas
Solo están disponibles las vitrinas universales

LUCE INF.	Color de frente	Carcasa	Costado visto	W 19	W50+100	XW5/XW6	Zócalos	Estantes
N158 007	optiwhite	*	UVHG/SG	UVHG/SG	-	UVHG	SG	SG
N158 101	snow	*	UVHG/SG	UVHG/SG	-	UVHG	SG	SG



optiwhite snow

Lacado alto brillo anti UV con canteado imitación vidrio.

Configuración de posiciones de tirador LUCE INFINITY

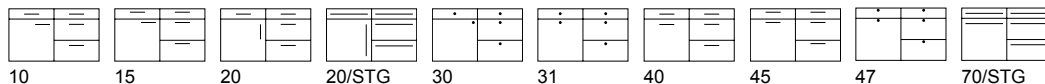

10 15 20 20/STG 30 31 40 45 47 70/STG



P
R
E
M
I
U
M

PASSION	COM	Color de frente	Carcasa	Costado visto	W 19	W 50	XW5/ XW6	Zócalos	Estantes
P247	101	P357	101	snow	KS	SG/LG	SG/LG	SG/LG	SG
PASSION R2	RAL	Color de frente	Carcasa	Costado visto	W 19	W 50	XW5/ XW6	Zócalos	Estantes
P557	000	RAL, Sikkens, NCS	*	LG	LG	LG	LG	LG	-

PASSION RAL COM no está disponible

Vitrinas

L Vitrina con montantes verticales

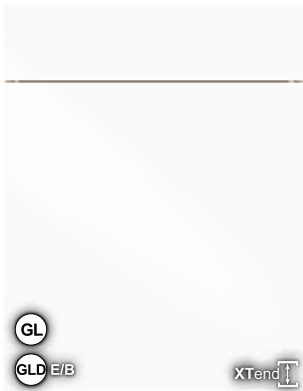

L
I
T
E

PASSION	Color de frente	Carcasa	Costado visto	W 19	W 50	XW5/ XW6	Zócalos	Estantes	
L247	101	snow	*	SG/LG	SG/LG	SG/LG	LG	SG/LG	SG

Vitrinas

Solo están disponibles las vitrinas universales

XTend Puertas XTend (a medida), con canto inferior metálico

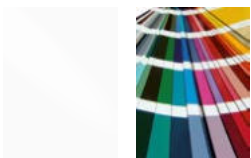

Colores RAL, Sikkens, NCS

La posibilidad de lacado en carta de color solo está disponible para cocinas completas. En pedidos pequeños hasta 10 puertas, se valorará bajo demanda y con suplemento. No disponibles colores metálicos!

Lacado alto brillo con radio de 2 mm.

Se deben solicitar frentes y puertas RAL dentro de los siguientes 6 meses desde el pedido, a fin de evitar diferencias menores de color.

snow **GL** XTend WALL

Configuración de posiciones de tirador PASSION + RAL

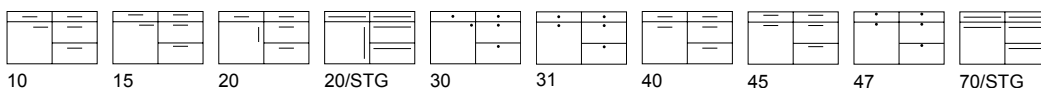

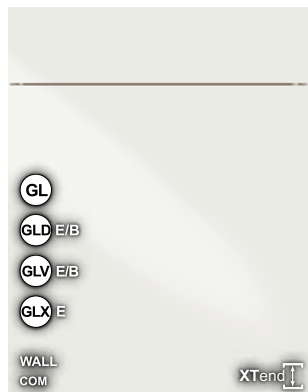

**P
R
E
M
I
U
M**

LUCIDA	COM	Color de frente	Carcasa	Costado visto	W 19	W 50	XW5/ XW6	Zócalos	Estantes
P282 006	P292 006	blanco	KS	SG/LG	SG/LG	SG/LG	LG	SG/LG	SG

Vitrinas

L Vitrina con montantes verticales



**L
I
T
E**

LUCIDA	Color de frente	Carcasa	Costado visto	W 19	W 50	XW5/ XW6	Zócalos	Estantes
L282 006	blanco	KS	SG/LG	SG/LG	SG/LG	LG	SG/LG	SG

Vitrinas

Solo están disponibles las vitrinas universales



Lacado alto brillo con radio de 3 mm.

XTend Puertas XTend (a medida),
con canto inferior metálico

blanco

Configuración de posiciones de tirador LUCIDA

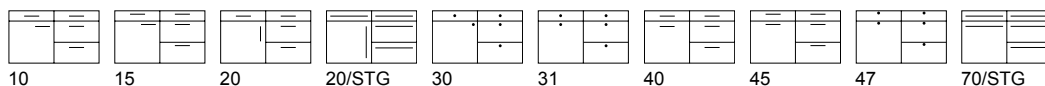

10 15 20 20/STG 30 31 40 45 47 70/STG



P R E M I U M

ART-GLAS GLOSS	Color de frente	Carcasa	Costado visto	W 19	W50+100	XW5/ XW6	Zócalos	Estantes
P316 006	bianco	KS	ACG	ACG*	-	ACG	ACG	-
P316 022	negro	KS	ACG	ACG*	-	ACG	ACG	-
P316 105	fumo	*	ACG	ACG*	-	ACG	ACG	-
P316 024	cachemir	KS	ACG	ACG*	-	ACG	ACG	-
P316 101	snow	KS	ACG	ACG*	-	ACG	ACG	-

* ¡los costados están disponibles con un solo lado acrílico, el dorso es laminado del mismo color!

PROPIEDADES DEL EFECTO VIDRIO BRILLANTE:

- efecto de brillo profundo simulando vidrio
- 50% más ligero
- 10 veces más resistente a los impactos que el vidrio real
- alta resistencia a los rayones
- fácil de limpiar gracias a las nanopropiedades
- certificado TÜV - perforación posible

Vitrinas

Solo están disponibles las vitrinas universales

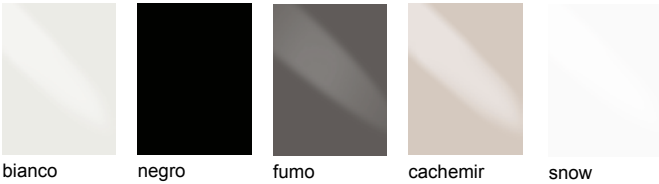

Frontal de acrílico de efecto cristal de alta calidad con borde biselado brillante

Configuración de posiciones de tirador ART-GLAS GLOSS

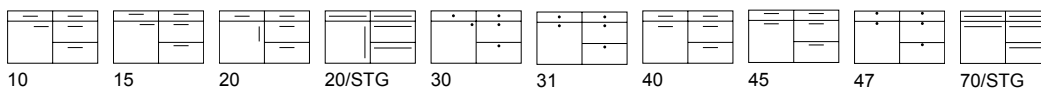



**Acabados
polilamina-
dos**

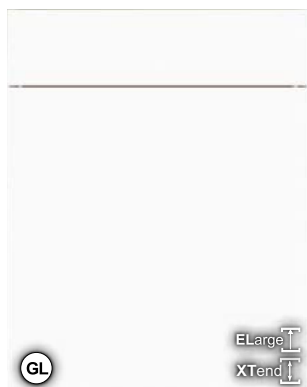

ZERO
sin ranurado

Vitrinas
R Vitrina con marco cuadrado,
L Vitrina con montantes verticales

PREMIUM



UNO
con una ranura vertical
en el centro



R20
con ranuras verticales cada
200 mm
Anotación
Las siguientes anchuras
tienen distancia entre
ranuras especial:
30 cm = 148 mm
45+90 cm = 223 mm
50 cm = 248 mm



R15
con ranuras verticales cada
150 mm
Anotación
Las siguientes anchuras
tienen distancia entre
ranuras especial:
40+80 cm = 132 mm
50+100 cm = 165 mm

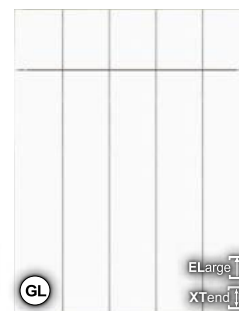

R10
con ranuras verticales cada
100 mm
Anotación
Las siguientes anchuras
tienen distancia entre
ranuras especial:
45 cm = 89 mm

ZERO	UNO	R20	R15	R10	Color de frente	Carcasa	Costado visto	W 19	W50+100	XW5	Zócalos	Estantes
P235 006	P236 006	P239 006	P238 006	P237 006	bianco	KS	-	KS*	KS W100	-	KS	KS
P235 024	P236 024	P239 024	P238 024	P237 024	cachemir	KS	-	KS*	KS	-	KS	KS
P235 090	P236 090	P239 090	P238 090	P237 090	magnolia	KS	-	KS*	KS W100	-	KS	KS

KS* También disponibles Costado de 19 mm con ranurados!

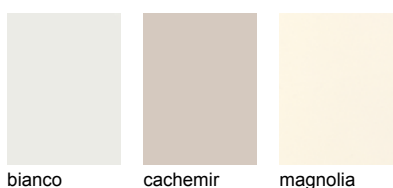

Polilaminado **mate** con o sin ranurado(s) vertical(es)

Configuración de posiciones de tirador **GROOVE MATT ZERO**

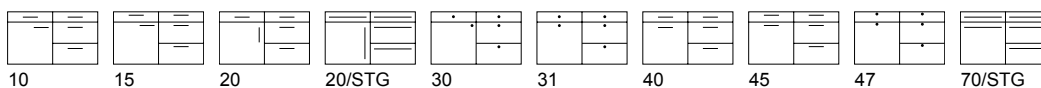

Configuración de posiciones de tirador **GROOVE MATT UNO + R20 + R15 + R10**

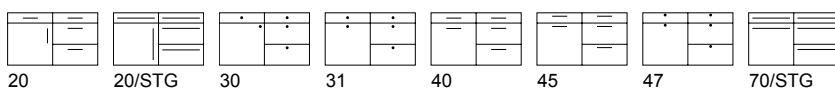

CASTLE MATT

Polilaminado



PREMIUM

CASTLE MATT	Color de frente	Carcasa	Costado visto	W 19	Pilastras	OZ 53/54 KL/LL	Zócalos	Estantes
P220 006	bianco	KS	-	KS*	K	KS	KS	KS
P220 024	cachemir	KS	-	KS*	K	KS	KS	KS
P220 090	magnolia	KS	-	KS*	K	KS	KS	KS

Atención!

KS* También disponibles Costado de 19 mm con ranurados!

Pilastra: K = polilaminado mate (Castle)

Vitrinas

R Vitrina con marco cuadrado,
L Vitrina con montantes verticales

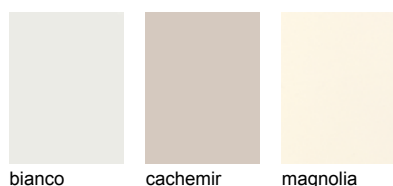

Polilaminado **mate** con marco de 7 cm y plafón central con ranurado

Configuración de posiciones de tirador CASTLE MATT

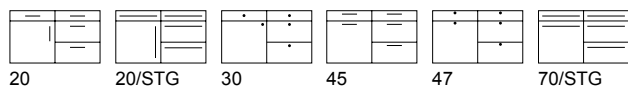

MEDA MATT

Polilaminado



PREMIUM

MEDA MATT	Color de frente	Carcasa	Costado visto	W 19	Pilastras	OZ 14/15 OZ 36/37 KL/LL	Zócalos	Estantes
P240 006	bianco	KS	-	KS	K	KS	KS	KS
P240 024	cachemir	KS	-	KS	K	KS	KS	KS
P240 090	magnolia	KS	-	KS	K	KS	KS	KS

Atención!

Pilastra: K = polilaminado mate (Meda)

Las cornisas y los tapaluces vienen en lacado del mismo color

Vitrinas

R Vitrina con marco cuadrado,
L Vitrina con montantes verticales

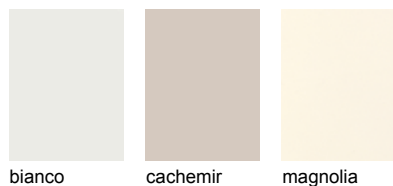

Polilaminado sobre DM (MDF) con marco de 7 cm recortado en chafán hacia el interior

Configuración de posiciones de tirador MEDA MATT

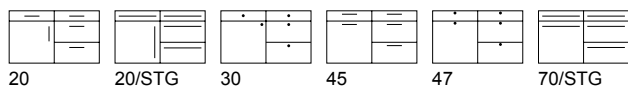



**P
R
E
M
I
U
M**

MODERNO MATT	Color de frente	Carcasa	Costado		W 19	Pilastras	KL/LL	Zócalos	Estantes
			visto						
P241 006	bianco	KS	-	KS	KS W100	-	KS	KS	
P241 024	cachemir	KS	-	KS	KS	-	KS	KS	
P241 090	magnolia	KS	-	KS	KS W100	-	KS	KS	

Vitrinas

R Vitrina con marco cuadrado,
L Vitrina con montantes verticales

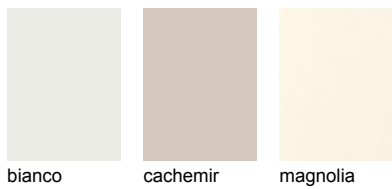

Polilaminado **mate** con marco de 7 cm y panel central liso

Configuración de posiciones de tirador MODERNO MATT

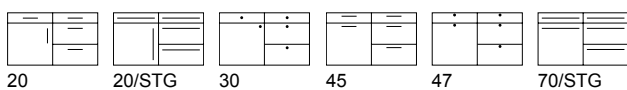



**Wood
Range
+
Wood
Specials**

NEW

Wood Range + Wood Specials overview

Wood Range *Información*

8 programas disponibles con distintos acabados superficiales: „Knotty raw“, „Knotty brushed“, „Striped brushed“ y „Silky smart“. Los detalles de estos programas se pueden ver a partir de la página 58.



MERINO H/V



SPLIT-PLANK
OAK V



SPLIT-OAK H/V



LAMELLA



CADRE



TELAIO



STRETTO

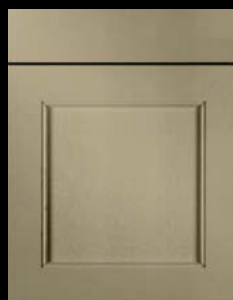

TOSCANA

Wood Specials *Información*

8 programas disponibles con un único acabado superficial. Los detalles de estos programas se pueden ver a partir de la página 66.



ROUGH ZERO+R15



REAL-OAK H/V



VERTICO V



BLACK STRIPE V



BLACK-LINE

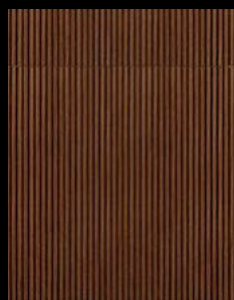

NOTCHO



ORBITA



RIPIENO

Wood Range + Specials



Knotty raw

Rechapado grueso nudoso, arenado y cepillado

F1 = *Knotty raw*

Nombre del modelo	Color de frente	Carcasa	Costado visto	Costados decorativos	XW5/ XW6	Zócalos	Estantes
P462 102	nature	*	F1	F1/*	F1	F1	



Knotty brushed

Rechapado nudoso, cepillado profundo

F2 = *Knotty brushed*

Nombre del modelo	Color de frente	Carcasa	Costado visto	Costados decorativos	XW5/ XW6	Zócalos	Estantes
P462 102	nature	*	F2	F2/*	F2	F2	F2

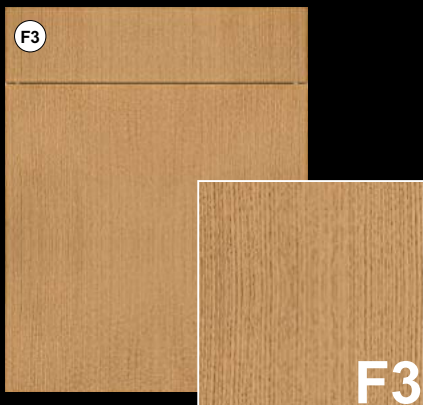

Striped brushed

Rechapado fino poco nudoso, cepillado superficial

F3 = *Striped brushed*

Nombre del modelo	Color de frente	Carcasa	Costado visto	Costados decorativos	XW5/ XW6	Zócalos	Estantes
P462 102	nature	*	F3	F3/*	F3	F3	F3

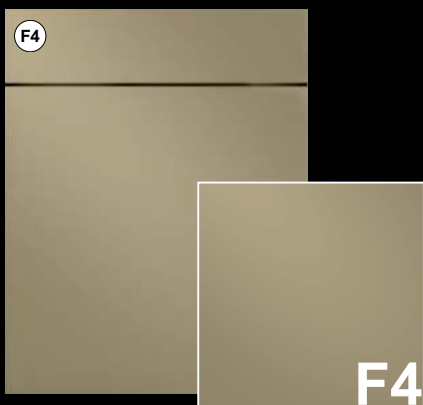

Silky smart

Satinado, lacado

F4 = *Silky smart*

Nombre del modelo	Color de frente	Carcasa	Costado visto	Costados decorativos	XW5/ XW6	Zócalos	Estantes
P650 032	olive	*	F4	F4/*	-	F4	F4

Wood Range

Doortypes	Woodstructures				Woodcolours			Lacquer colours		
	F1	F2	F3	F4						
MERINO H/V					beachwood	tiza	castaño	bianco	negro	oliva
					driftwood	nature	nogal	shell		
SPLIT-PLANK OAK V					castaño	nature				
SPLIT-OAK H/V					castaño	nature				
LAMELLA					tiza	castaño		negro		
					nature					
CADRE					castaño	nature		negro		
TELAIO					beachwood	tiza	castaño	bianco	negro	oliva
					driftwood	nature		shell		
STRETTO					castaño	nature		negro		
TOSCANA								bianco	negro	oliva
								shell		

Wood Specials

Doortypes	Woodstructures				Woodcolours			Lacquer colours
	F1	F2	F3	F4				
 ROUGH ZERO+R15					 negro	 grafito	 pastell loam	
					 pastell shadow	 pastell smoke	 playa	
 REAL-OAK H/V					 tiza	 castaño	 real-nature	
 VERTICO V					 tiza	 castaño	 driftwood	 bianco
					 nature	 nogal		 negro
 BLACK STRIPE V					 castaño	 nature	 nogal	 oliva
 BLACK-LINE					 nature			
 NOTCHO					 nature	 nogal	 negro	 RAL SIKKENS NCS
 ORBITA					 beachwood	 driftwood	 nature	 RAL SIKKENS NCS
 RIPIENO					 beachwood	 driftwood	 nature	 RAL SIKKENS NCS

Acabados en melamina

Acabados mates

Acabados brillantes

Acabados pollaminados

Wood Range + Wood Specials

Tiradores, encimeras, tablas de acabados, modelos descatalogados

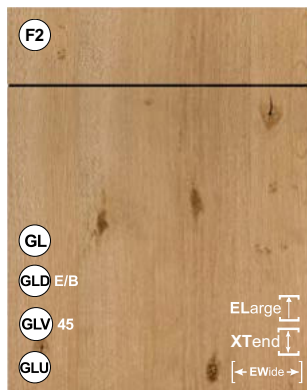

**P
R
E
M
I
U
M**

ZERO H/V

sin ranurado
Frente liso rechapado

Vitrinas

G/GA/GM/R Vitrina con marco cuadrado
(solamente para modelo ZERO),
L Vitrina con montantes verticales

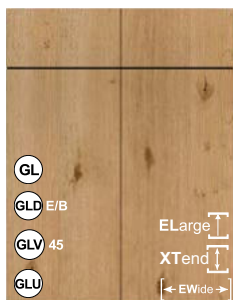

UNO

con una ranura
vertical en el centro

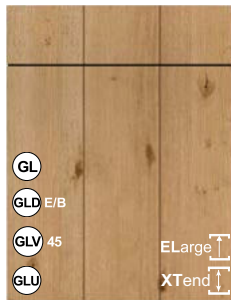

R20

con ranuras verticales
cada 200 mm

Anotación

Las siguientes anchuras
tienen distancia entre
ranuras especial:
30 cm = 148 mm
45+90 cm = 223 mm
50 cm = 248 mm



R15

con ranuras verticales
cada 150 mm

Anotación

Las siguientes anchuras
tienen distancia entre
ranuras especial:
40+80 cm = 132 mm
50+100 cm = 165 mm



R10

con ranuras verticales
cada 100 mm

Anotación

Las siguientes anchuras
tienen distancia entre
ranuras especial:
45 cm = 89 mm



beachwood tiza castaño driftwood nature nogal solamente en F2 + F3



blanco negro oliva shell

**Colores RAL, Sikkens,
NCS**

La posibilidad de lacado en carta
de color solo está disponible para
cocinas completas. En pedidos pe-
queños hasta 10 puertas, se valorará
bajo demanda y con suplemento.
No disponibles colores metálicos!

F1/*, F2/*, F3/* Para este acabado, hay disponibles costados lisos (OLWR) o ranurados (OLW) de los siguientes grosores: 19,50,75 y 100 mm.

Configuración de posiciones de tirador

MERINO H/V F1, F2, F3 ZERO

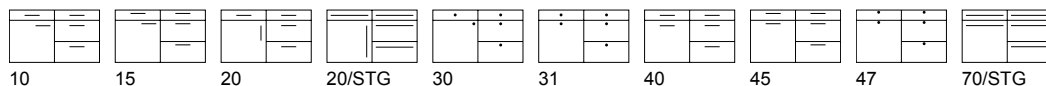

Configuración de posiciones de tirador

MERINO H/V F1, F2, F3 UNO + R20 + R15 + R10

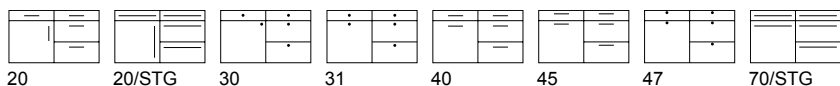

F1 (anteriormente LEGNO)

Knotty raw

Frente: Rechapado tratado con chorro de arena y vetado muy profundo, sobre tablero de aglomerado. Frente 21mm de grosor, OLW19 21 mm de grosor

ZERO H	ZERO V	UNO	R20	R15	R10	Color de frente	Carcasa	Costado visto	Costados decorativos	XW5/XW6	Zócalos	Estantes
P461 019	P462 019	P465 019	P466 019	P468 019	P469 019	beachwood	*	F1	F1/*	F1	F1	F2
P461 104	P462 104	P465 104	P466 104	P468 104	P469 104	tiza	*	F1	F1/*	F1	F1	F2
P461 121	P462 121	P465 121	P466 121	P468 121	P469 121	castaño	*	F1	F1/*	F1	F1	F2
P461 031	P462 031	P465 031	P466 031	P468 031	P469 031	driftwood	*	F1	F1/*	F1	F1	F2
P461 102	P462 102	P465 102	P466 102	P468 102	P469 102	nature	*	F1	F1/*	F1	F1	F2
P461 006	P462 006	P465 006	P466 006	P468 006	P469 006	bianco	KS	F1	F1/*	F1	F1	F2
P461 022	P462 022	P465 022	P466 022	P468 022	P469 022	negro	KS	F1	F1/*	F1	F1	F2
P461 032	P462 032	P465 032	P466 032	P468 032	P469 032	oliva	*	F1	F1/*	F1	F1	F2
P461 244	P462 244	P465 244	P466 244	P468 244	P469 244	shell	KS	F1	F1/*	F1	F1	F2

RAL

RAL ZERO	RAL ZERO	UNO	R20	R15	R10							
P571 000	P572 000	P575 000	P576 000	P578 000	P579 000	RAL-, Sikkens-, NCS	*	F1	F1/*	F1	F1	F2

Los estantes solo están disponibles en F2 cepillado

Acabados mates

Acabados brillantes

F2 (anteriormente MERINO)

Knotty brushed

Frente: Rechapado de roble o nogal con tratamiento de cepillado profundo

ZERO H	ZERO V	UNO	R20	R15	R10	Color de frente	Carcasa	Costado visto	Costados decorativos	XW5/XW6	Zócalos	Estantes
P401 019	P402 019	P405 019	P406 019	P408 019	P409 019	beachwood	*	F2	F2/*	F2	F2	F2
P401 104	P402 104	P405 104	P406 104	P408 104	P409 104	tiza	*	F2	F2/*	F2	F2	F2
P401 121	P402 121	P405 121	P406 121	P408 121	P409 121	castaño	*	F2	F2/*	F2	F2	F2
P401 031	P402 031	P405 031	P406 031	P408 031	P409 031	driftwood	*	F2	F2/*	F2	F2	F2
P401 102	P402 102	P405 102	P406 102	P408 102	P409 102	nature	*	F2	F2/*	F2	F2	F2
P401 216	P402 216	P405 216	P406 216	P408 216	P409 216	nogal	*	F2	F2/*	F2	F2	F2

P401 006	P402 006	P405 006	P406 006	P408 006	P409 006	bianco	KS	F2	F2/*	F2	F2	F2
P401 022	P402 022	P405 022	P406 022	P408 022	P409 022	negro	KS	F2	F2/*	F2	F2	F2
P401 032	P402 032	P405 032	P406 032	P408 032	P409 032	oliva	*	F2	F2/*	F2	F2	F2
P461 244	P402 244	P405 244	P406 244	P408 244	P409 244	shell	KS	F2	F2/*	F2	F2	F2

RAL

RAL ZERO	RAL ZERO	UNO	R20	R15	R10							
P581 000	P582 000	P585 000	P586 000	P588 000	P589 000	RAL-, Sikkens-, NCS	*	F2	F2/*	F2	F2	F2

Acabados polilaminados

Wood Range + Wood Specials

F3 (NUEVO)

Striped brushed

Frente: Rechapado de roble o nogal sin nudos con tratamiento de cepillado superficial

ZERO H	ZERO V	UNO	R20	R15	R10	Color de frente	Carcasa	Costado visto	Costados decorativos	XW5/XW6	Zócalos	Estantes
P421 019	P422 019	P425 019	P426 019	P428 019	P429 019	beachwood	*	F3	F3/*	F3	F3	F3
P421 104	P422 104	P425 104	P426 104	P428 104	P429 104	tiza	*	F3	F3/*	F3	F3	F3
P421 121	P422 121	P425 121	P426 121	P428 121	P429 121	castaño	*	F3	F3/*	F3	F3	F3
P421 031	P422 031	P425 031	P426 031	P428 031	P429 031	driftwood	*	F3	F3/*	F3	F3	F3
P421 102	P422 102	P425 102	P426 102	P428 102	P429 102	nature	*	F3	F3/*	F3	F3	F3
P421 216	P422 216	P425 216	P426 216	P428 216	P429 216	nogal	*	F3	F3/*	F3	F3	F3

P421 006	P422 006	P425 006	P426 006	P428 006	P429 006	bianco	KS	F3	F3/*	F3	F3	F3
P421 022	P422 022	P425 022	P426 022	P428 022	P429 022	negro	KS	F3	F3/*	F3	F3	F3
P421 032	P422 032	P425 032	P426 032	P428 032	P429 032	oliva	*	F3	F3/*	F3	F3	F3
P421 244	P422 244	P425 244	P426 244	P428 244	P429 244	shell	KS	F3	F3/*	F3	F3	F3

RAL

RAL ZERO	RAL ZERO	UNO	R20	R15	R10							
P491 000	P492 000	P495 000	P496 000	P498 000	P499 000	RAL-, Sikkens-, NCS	*	F3	F3/*	F3	F3	F3

Tiradores, encimeras, tablas de acabados, modelos descatalogados



PREMIUM

Vitrinas

L vitrina con montantes verticales laterales



castaño, V nature, V

F1 (anteriormente PLANK-OAK)

Knotty raw

Frente: Roble envejecido, alistonado (listones rechapados) y arenado

SPLIT PLANK-OAK V	Color de frente	Carcasa	Costado visto	Costados decorativos	XW5/ XW6	Zócalos	Estantes
P517 121	castaño, V	*	F1	F1/*	F1	F1	F2
P517 102	nature, V	*	F1	F1/*	F1	F1	F2

Los costados vistos son lisos, no alistonados. Los estantes solo están disponibles en F2 **cepillado**

F2 (NUEVO)

Knotty brushed

Frente: Roble envejecido, alistonado (listones rechapados) y cepillado

SPLIT PLANK-OAK V	Color de frente	Carcasa	Costado visto	Costados decorativos	XW5/ XW6	Zócalos	Estantes
P527 121	castaño, V	*	F2	F2/*	F2	F2	F2
P527 102	nature, V	*	F2	F2/*	F2	F2	F2

Los costados vistos son lisos, no alistonados.

F1/*, F2/* Los costados están disponibles alistonados (OWLR) o lisos (OLW) en espesores de 19, 50, 75 y 100 mm.

Configuración de posiciones de tirador

SPLIT PLANK-OAK V F1, F2

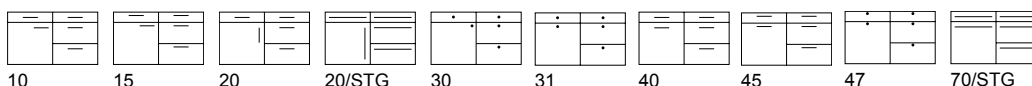

PREMIUM

Vitrinas

R Vitrina con marco cuadrado,
H Puerta de madera en la parte inferior,
con vidrio en alto



castaño, H/V nature, H/V

F1 (NUEVO)

Knotty raw

Frente: Roble nudoso, arenado

SPLIT OAK H	Color de frente	Carcasa	Costado visto	Costados decorativos	XW5/ XW6	Zócalos	Estantes
P523 121	castaño, H	*	F1	F1/*	F1	F1	F2
P523 102	nature, H	*	F1	F1/*	F1	F1	F2

SPLIT OAK V	Color de frente	Carcasa	Costado visto	Costados decorativos	XW5/ XW6	Zócalos	Estantes
P524 121	castaño, V	*	F1	F1/*	F1	F1	F2
P524 102	nature, V	*	F1	F1/*	F1	F1	F2

Los estantes solo están disponibles en F2 **cepillado**

F2 (anteriormente SPLIT-OAK)

Knotty brushed

Frente: Roble nudoso, cepillado

SPLIT OAK H	Color de frente	Carcasa	Costado visto	Costados decorativos	XW5/ XW6	Zócalos	Estantes
P543 121	castaño, H	*	F2	F2/*	F2	F2	F2
P543 102	nature, H	*	F2	F2/*	F2	F2	F2

SPLIT OAK V	Color de frente	Carcasa	Costado visto	Costados decorativos	XW5/ XW6	Zócalos	Estantes
P544 121	castaño, V	*	F2	F2/*	F2	F2	F2
P544 102	nature, V	*	F2	F2/*	F2	F2	F2

Configuración de posiciones de tirador

SPLIT OAK H/V F1, F2

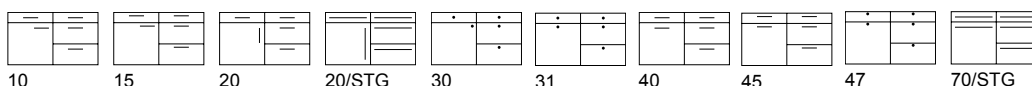



PREMIUM

Vitrinas
Solo vitrinas universales disponibles

F2 (anteriormente LAMELLA) Knotty brushed

Frente: Rechapado cepillado veteado y nudoso, sobre tablero de MDF (DM), con lamellas horizontales, la distancia entre lamellas es de 13 mm. El frente tiene un grosor de 21,7 mm.

LAMELLA	Color de frente	Carcasa	Costado visto	Costados decorativos	XW5/ XW6	Zócalos	Estantes
P652 022	negro	KS	F2	F2	F2	F2	F2
P652 104	tiza	*	F2	F2	F2	F2	F2
P652 121	castaño	*	F2	F2	F2	F2	F2

RAL	Color de frente	Carcasa	Costado visto	Costados decorativos	XW5/ XW6	Zócalos	Estantes
	RAL-, Sikkens-, NCS	*	F2	F2	F2	F2	F2

¡Los costados solo se pueden entregar lisos, sin listones!



negro tiza castaño



Colores RAL, Sikkens, NCS.

La posibilidad de lacado en carta de color solo está disponible para cocinas completas. En pedidos pequeños hasta 10 puertas, se valorará bajo demanda y con suplemento. No disponibles colores metálicos!

F3 (NUEVO) Striped brushed

Frente: Rechapado cepillado sin veta y nudoso, sobre tablero de MDF (DM), con lamellas horizontales, la distancia entre lamellas es de 13 mm. El frente tiene un grosor de 21,7 mm.

LAMELLA	Color de frente	Carcasa	Costado visto	Costados decorativos	XW5/ XW6	Zócalos	Estantes
P612 022	negro	KS	F3	F3	F3	F3	F3
P612 104	tiza	*	F3	F3	F3	F3	F3
P612 121	castaño	*	F3	F3	F3	F3	F3

RAL	Color de frente	Carcasa	Costado visto	Costados decorativos	XW5/ XW6	Zócalos	Estantes
	RAL-, Sikkens-, NCS	*	F3	F3	F3	F3	F3

¡Los costados solo se pueden entregar lisos, sin listones!

Debido al ranurado horizontal, GL780 y S126 no se pueden combinar (las columnas con golas verticales no se pueden combinar con muebles bajos con gola)

Configuración de posiciones de tirador LAMELLA F2, F3

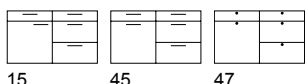

15 45 47



PREMIUM

Vitrinas
RQ Puerta de vitrina con marco y travesaño

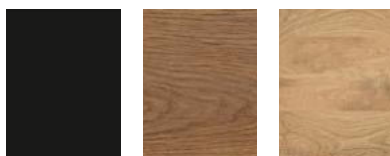

negro castaño nature



Colores RAL, Sikkens, NCS

La posibilidad de lacado en carta de color solo está disponible para cocinas completas. En pedidos pequeños hasta 10 puertas, se valorará bajo demanda y con suplemento. No disponibles colores metálicos!

F1 (anteriormente CADRE)

Knotty raw

Frente: Travesaños superior e inferior de 23 mm de grosor, de madera maciza arenada, con uñero integrado, de 9 cm de anchura, con travesaños laterales de 5,5 cm de anchura y panel central rechapado natural cepillado

CADRE	Color de frente	Carcasa	Costado visto	Costados decorativos	XW5/XW6	Zócalos	Estantes
P636 022	negro	KS	F1	F1/*	-	F1	F2
P636 121	castaño	*	F1	F1/*	-	F1	F2
P636 102	nature	*	F1	F1/*	-	F1	F2

RAL

P637 000	RAL-, Sikkens-, NCS	*	F1	F1/*	-	F1	F2
----------	---------------------	---	----	------	---	----	----

Los estantes solo están disponibles en F2 cepillado

F2 (NUEVO)

Knotty brushed

Frente: Travesaños superior e inferior de 23 mm de grosor, de madera maciza cepillada con uñero integrado, de 9 cm de anchura, con travesaños laterales de 5,5 cm de anchura y panel central rechapado natural cepillado

CADRE	Color de frente	Carcasa	Costado visto	Costados decorativos	XW5/XW6	Zócalos	Estantes
P656 022	negro	KS	F2	F2/*	-	F2	F2
P656 121	castaño	*	F2	F2/*	-	F2	F2
P656 102	nature	*	F2	F2/*	-	F2	F2

RAL

P666 000	RAL-, Sikkens-, NCS	*	F2	F2/*	-	F2	F2
----------	---------------------	---	----	------	---	----	----

F3 (NUEVO)

Striped brushed

Frente: Travesaños superior e inferior de 23 mm de grosor, de madera maciza cepillada suavemente con uñero integrado, de 9 cm de anchura, con travesaños laterales de 5,5 cm de anchura y panel central rechapado suave cepillado

CADRE	Color de frente	Carcasa	Costado visto	Costados decorativos	XW5/XW6	Zócalos	Estantes
P616 022	negro	KS	F3	F3/*	-	F3	F3
P616 121	castaño	*	F3	F3/*	-	F3	F3
P616 102	nature	*	F3	F3/*	-	F3	F3

RAL

P617 000	RAL-, Sikkens-, NCS	*	F3	F3/*	-	F3	F3
----------	---------------------	---	----	------	---	----	----

F1/*, F2/*, F3/* Para este acabado, hay disponibles costados lisos (OLWR) o ranurados (OLW) de los siguientes grosores: 19,50,75 y 100 mm.

Anotación:

- Los frentes de cajones son lisos y únicamente se pueden abrir mediante Tip-On. Recomendamos como alternativa solicitar el mueble con gaveteros y cajón(es) interior(es).
- No hay disponibilidad de frentes de gavetero de 256 mm.
- Todo frente de altura inferior a 296 mm solo está disponible en su versión lisa.
- Es preferible colocar los frigoríficos sobre una altura de 78 cm, a fin de garantizar una apertura ergonómica de la puerta.



P
R
E
M
I
U
M

Vitrinas
R Vitrina con marco cuadrado,
H Puerta de madera en la parte
inferior, con vidrio en alto

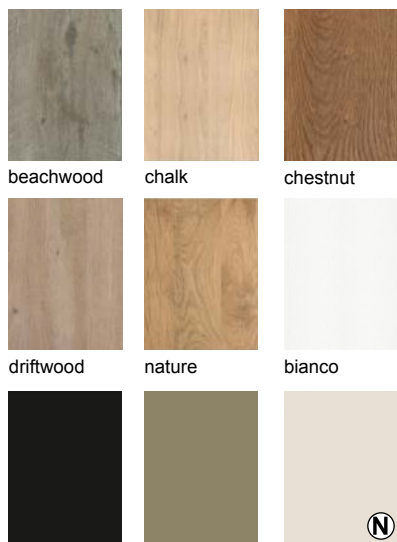

Colores RAL, Sikkens,
NCS.

La posibilidad de lacado
en carta de color solo
está disponible para
cocinas completas. En
pedidos pequeños hasta
10 puertas, se valorará
bajo demanda y con
suplemento.
No disponibles colores
metálicos!

Configuración de posiciones de tirador

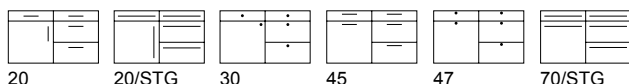

TELAIO F1, F2, F3

F1 (anteriormente TELAIO) Knotty raw

Frente: Marco perimetral de madera maciza arenada, de 9 cm de anchura, con panel intermedio rechapado

TELAIO	Color de frente	Carcasa	Costado visto	Costados decorativos	XW5/XW6	Zócalos	Estantes
P634 019	beachwood	*	F1	F1/*	F1	F1	F2
P634 104	tiza	*	F1	F1/*	F1	F1	F2
P634 121	castaño	*	F1	F1/*	F1	F1	F2
P634 031	driftwood	*	F1	F1/*	F1	F1	F2
P634 102	nature	*	F1	F1/*	F1	F1	F2
P634 006	bianco	KS	F1	F1/*	F1	F1	F2
P634 022	negro	KS	F1	F1/*	F1	F1	F2
P634 032	oliva	*	F1	F1/*	F1	F1	F2
P634 244	shell	KS	F1	F1/*	F1	F1	F2
RAL							
P635 000	RAL-, Sikkens-, NCS	*	F1	F1/*	F1	F1	F2

Los estantes solo están disponibles en F2 cepillado

F2 (NUEVO) Knotty brushed

Frente: Marco perimetral de madera maciza cepillada de 9 cm de anchura, con panel intermedio rechapado

TELAIO	Color de frente	Carcasa	Costado visto	Costados decorativos	XW5/XW6	Zócalos	Estantes
P654 019	beachwood	*	F2	F2/*	F2	F2	F2
P654 104	tiza	*	F2	F2/*	F2	F2	F2
P654 121	castaño	*	F2	F2/*	F2	F2	F2
P654 031	driftwood	*	F2	F2/*	F2	F2	F2
P654 102	nature	*	F2	F2/*	F2	F2	F2
P654 006	bianco	KS	F2	F2/*	F2	F2	F2
P654 022	negro	KS	F2	F2/*	F2	F2	F2
P654 032	oliva	*	F2	F2/*	F2	F2	F2
P654 244	shell	KS	F2	F2/*	F2	F2	F2
RAL							
P655 000	RAL-, Sikkens-, NCS	*	F2	F2/*	F2	F2	F2

F3 (NUEVO) Striped brushed

Frente: Marco perimetral de madera maciza suave cepillada de 9 cm de anchura, con panel intermedio rechapado

TELAIO	Color de frente	Carcasa	Costado visto	Costados decorativos	XW5/XW6	Zócalos	Estantes
P614 019	beachwood	*	F3	F3/*	F3	F3	F3
P614 104	tiza	*	F3	F3/*	F3	F3	F3
P614 121	castaño	*	F3	F3/*	F3	F3	F3
P614 031	driftwood	*	F3	F3/*	F3	F3	F3
P614 102	nature	*	F3	F3/*	F3	F3	F3
P614 006	bianco	KS	F3	F3/*	F3	F3	F3
P614 022	negro	KS	F3	F3/*	F3	F3	F3
P614 032	oliva	*	F3	F3/*	F3	F3	F3
P614 244	shell	KS	F3	F3/*	F3	F3	F3
RAL							
P615 000	RAL-, Sikkens-, NCS	*	F3	F3/*	F3	F3	F3

F1/*, F2/*, F3/* Para este acabado, hay disponibles costados lisos (OLWR) o ranurados (OLW) de los siguientes grosores: 19,50,75 y 100 mm.



PREMIUM

Vitrinas

Solo vitrinas universales disponibles

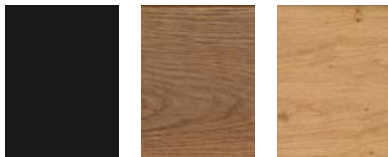

negro castaño nature



Colores RAL, Sikkens, NCS

La posibilidad de lacado en carta de color solo está disponible para cocinas completas. En pedidos pequeños hasta 10 puertas, se valorará bajo demanda y con suplemento. No disponibles colores metálicos!

F1 (anteriormente STRETTO)

Knotty raw

Frente: Travesaños superior e inferior de 21 mm de grosor, de madera maciza arenada, de 8 cm de anchura, con travesaños laterales de 1,2 cm de anchura y panel central rechapado natural arenado

STRETTO	Color de frente	Carcasa	Costado visto	Costados decorativos	XW5/ XW6	Zócalos	Estantes
P638 022	negro	KS	F1	F1/*	-	F1	F2
P638 121	castaño	*	F1	F1/*	-	F1	F2
P638 102	nature	*	F1	F1/*	-	F1	F2

RAL

P639 000	RAL-, Sikkens-, NCS	*	F1	F1/*	-	F1	F2
----------	---------------------	---	----	------	---	----	----

Los estantes solo están disponibles en F2 cepillado

F2 (NUEVO)

Knotty brushed

Frente: Travesaños superior e inferior de 21 mm de grosor, de madera maciza cepillada de 8 cm de anchura, con travesaños laterales de 1,2 cm de anchura y panel central rechapado natural cepillado

STRETTO	Color de frente	Carcasa	Costado visto	Costados decorativos	XW5/ XW6	Zócalos	Estantes
P658 022	negro	KS	F2	F2/*	-	F2	F2
P658 121	castaño	*	F2	F2/*	-	F2	F2
P658 102	nature	*	F2	F2/*	-	F2	F2

RAL

P659 000	RAL-, Sikkens-, NCS	*	F2	F2/*	-	F2	F2
----------	---------------------	---	----	------	---	----	----

F3 (NUEVO)

Striped brushed

Frente: Travesaños superior e inferior de 21 mm de grosor, de madera maciza cepillada suavemente de 8 cm de anchura, con travesaños laterales de 1,2 cm de anchura y panel central rechapado natural suave

STRETTO	Color de frente	Carcasa	Costado visto	Costados decorativos	XW5/ XW6	Zócalos	Estantes
P618 022	negro	KS	F3	F3/*	-	F3	F3
P618 121	castaño	*	F3	F3/*	-	F3	F3
P618 102	nature	*	F3	F3/*	-	F3	F3

RAL

P619 000	RAL-, Sikkens-, NCS	*	F3	F3/*	-	F3	F3
----------	---------------------	---	----	------	---	----	----

F1/*, F2/*, F3/* Para este acabado, hay disponibles costados lisos (OLWR) o ranurados (OLW) de los siguientes grosores: 19,50,75 y 100 mm.

Configuración de posiciones de tirador

STRETTO F1, F2, F3

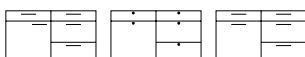

15

47

45

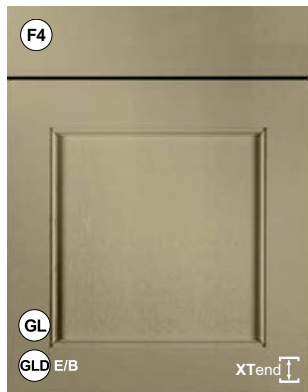

PREMIUM

Vitrinas

H Puerta de madera en la parte inferior, con vidrio en alto, R Vitrina con marco cuadrado, K Celosía interior



bianco negro oliva

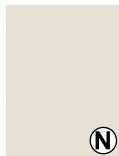

shell



Colores RAL, Sikkens, NCS

La posibilidad de lacado en carta de color solo está disponible para cocinas completas. En pedidos pequeños hasta 10 puertas, se valorará bajo demanda y con suplemento. No disponibles colores metálicos!

Se deben solicitar frentes y puertas RAL dentro de los siguientes 6 meses desde el pedido, a fin de evitar diferencias menores de color.

F2 (NUEVO)

Knotty brushed

Frente: Roble lacado mate con veta, con enmarcado mecanizado macizo de 7 cm de ancho, panel intermedio rechapado lacado mate

TOSCANA	Color de frente	Carcasa	Costado visto	Costados decorativos	XW5/ XW6	Pilastras	OZ 40/41		
							KL/LL	Zócalos	Estantes
P650 006	bianco	KS	F2	F2/*	-	M	F2	F2	F2
P650 022	negro	KS	F2	F2/*	-	M	F2	F2	F2
P650 032	oliva	*	F2	F2/*	-	M	F2	F2	F2
P650 244	shell	KS	F2	F2/*	-	M	F2	F2	F2
RAL									
P651 000	RAL-, Sikkens-, NCS	*	F2	F2/*	-	M	F2	F2	F2

F3 (NUEVO)

Striped brushed

Frente: Roble lacado mate, con enmarcado mecanizado macizo de 7 cm de ancho, panel intermedio rechapado lacado mate

TOSCANA	Color de frente	Carcasa	Costado visto	Costados decorativos	XW5/ XW6	Pilastras	OZ 40/41		
							KL/LL	Zócalos	Estantes
P620 006	bianco	KS	F3	F3/*	-	M	F3	F3	F3
P620 022	negro	KS	F3	F3/*	-	M	F3	F3	F3
P620 032	oliva	*	F3	F3/*	-	M	F3	F3	F3
P620 244	shell	KS	F3	F3/*	-	M	F3	F3	F3
RAL									
P621 000	RAL-, Sikkens-, NCS	*	F3	F3/*	-	M	F3	F3	F3

F4 anteriormente TOSCANA, normal, no PM)

Silky smart

Frente: Roble lacado mate satinado suave, con enmarcado mecanizado macizo de 7 cm de ancho, panel intermedio rechapado lacado mate

TOSCANA	Color de frente	Carcasa	Costado visto	Costados decorativos	XW5/ XW6	Pilastras	OZ 40/41		
							KL/LL	Zócalos	Estantes
P450 006	bianco	KS	F4	F4/*	-	M	F4	F4	F4
P450 022	negro	KS	F4	F4/*	-	M	F4	F4	F4
P450 032	oliva	*	F4	F4/*	-	M	F4	F4	F4
P450 244	shell	KS	F4	F4/*	-	M	F4	F4	F4
RAL									
P451 000	RAL-, Sikkens-, NCS	*	F4	F4/*	-	M	F4	F4	F4

Los modelos de la colección „Casa de campo“ están disponibles para este acabado!

F2/*, F3/*, F4/* In diesem Modell sind Wangen in gerillter (OLWR) oder glatter (OLW) Ausführung in der Stärke von 19 mm lieferbar.

Configuración de posiciones de tirador TOSCANA F2, F3, F4

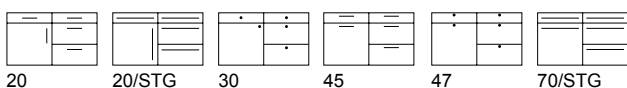

20 20/STG 30 45 47 70/STG

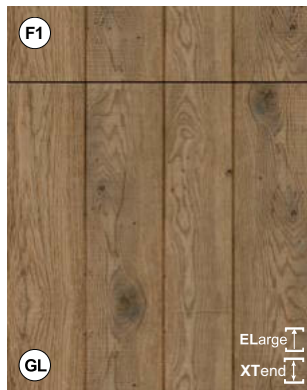

PREMIUM

ELarge
XTend

Vitrinas

L vitrina con montantes verticales laterales



negro grafito pastell loam
pastell shadow pastell smoke playa

F1 (anteriormente ROUGH) Knotty raw

Rechapado grueso de roble, sin ranurado (ZERO), o con ranurado cada 150 mm (R15), veteado vertical.

ZERO	R15	Color de frente	Carcasa	Costado visto	Costados decorativos	XW5	Zócalos	Estantes
P568 022	P569 022	negro	KS	F1	F1/*	F1	F1	-
P568 017	P569 017	grafito	KS	F1	F1/*	F1	F1	-
P568 155	P569 155	pastell loam	*	F1	F1/*	F1	F1	-
P568 156	P569 156	pastell shadow	*	F1	F1/*	F1	F1	-
P568 157	P569 157	pastell smoke	*	F1	F1/*	F1	F1	-
P568 158	P569 158	playa	*	F1	F1/*	F1	F1	-

F1/* Para este acabado, hay disponibles costados lisos (OLWR) o ranurados (OLW) de los siguientes grosores: 19,50,75 y 100 mm.

Anotaciones para R15:

El espacio de ranurado es normalmente de 150 mm, salvo en las siguientes medidas:
anchuras de 40 y 80 cm: espacio de 132 mm,
anchura de 50 cm: espacio de 124 mm,
anchura de 100 cm: espacio de 142 mm

Configuración de posiciones de tirador

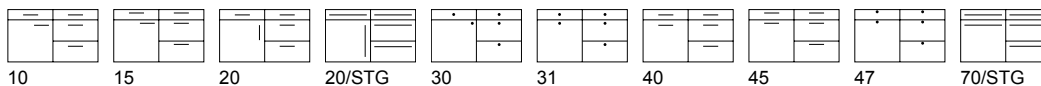

ROUGH ZERO F1

Configuración de posiciones de tirador

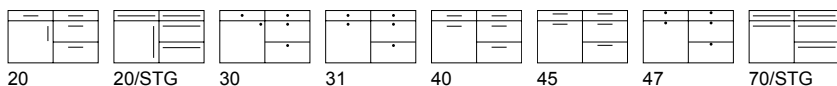

ROUGH R15 F1



PREMIUM

Vitrinas
G / GA / GM / R Puerta de vidrio con marco



tiza, H/V castaño, H/V real-nature, H/V

F2 (anteriormente REAL-OAK) Knotty brushed

Chapa industrial cepillada y lacada, sobre aglomerado, Decoración veteada horizontal / vertical, Canto del mismo color alrededor.

REAL-OAK H	Color de frente	Carcasa	Costado visto	W19	XW5/ XW6	Zócalos	Estantes
P359 104	tiza, H	*	F2	F2	F2	F2	F2
P359 121	castaño, H	*	F2	F2	F2	F2	F2
P359 177	real-nature, H	*	F2	F2	F2	F2	F2

REAL-OAK V	Color de frente	Carcasa	Costado visto	W19	XW5/ XW6	Zócalos	Estantes
P394 104	tiza, V	*	F2	F2	F2	F2	F2
P394 121	castaño, V	*	F2	F2	F2	F2	F2
P394 177	real-nature, V	*	F2	F2	F2	F2	F2

W19: Los costados de chapa industrial solo están disponibles en 19 mm de espesor y lisos (sin ranurado).

Queremos aclarar que las chapas industriales pueden variar en veteado, color y número de nudos y, por lo tanto, esto no puede ser motivo de queja.

Configuración de posiciones de tirador

REAL-OAK H/V F2

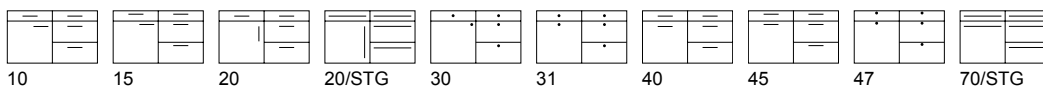



Vitrinas
Solo vitrinas universales disponibles

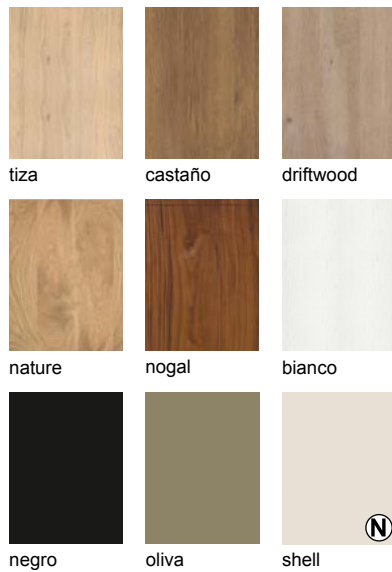

Colores RAL, Sikkens, NCS

La posibilidad de lacado en carta de color solo está disponible para cocinas completas. En pedidos pequeños hasta 10 puertas, se valorará bajo demanda y con suplemento. No disponibles colores metálicos!

F2 Knotty brushed

Frente: Rechapado de roble/castaño con veteado y nudos, cepillado sobre tablero de MDF (DM), con alistonado vertical. La distancia entre lamellas es de 5 mm. El frente tiene un grosor de 21 mm. La parte trasera es del mismo acabado pero liso.

VERTICO V	Color de frente	Carcasa	Costado visto	Costados decorativos	XW5/ XW6	Zócalos	Estantes
P610 104	tiza	*	F2/*1	F2/*2	-	F2	F2
P610 121	castaño	*	F2/*1	F2/*2	-	F2	F2
P610 031	driftwood	*	F2/*1	F2/*2	-	F2	F2
P610 102	nature	*	F2/*1	F2/*2	-	F2	F2
P610 216	nogal	*	F2/*1	F2/*2	-	F2	F2

P610 006	bianco	KS	F2/*1	F2/*2	-	F2	F2
P610 022	negro	KS	F2/*1	F2/*2	-	F2	F2
P610 032	oliva	*	F2/*1	F2/*2	-	F2	F2
P610 244	shell	KS	F2/*1	F2/*2	-	F2	F2

RAL

P611 000	RAL-, Sikkens-, NCS	*	F2/*1	F2/*2	-	F2	F2
----------	---------------------	---	-------	-------	---	----	----

Anotación:

Los costados vistos F2/*1 solo están disponibles en acabado liso.
Hay disponibles costados decorativos lisos de 19 mm (OLW) o con lamella vertical de 21 mm (OLWR).
Los costados decorativos de 50 y 100 mm solo están disponibles en acabado liso (OLW).

Solamente está disponible sin tirador o con tip-on, no es posible realizar ninguna perforación para colocar tiradores.

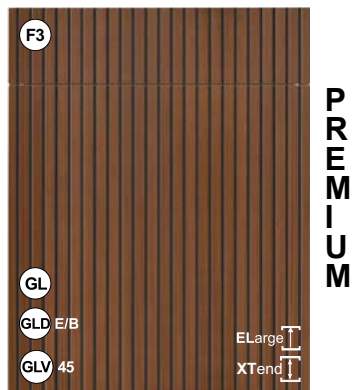

Vitrinas
Solo vitrinas universales disponibles



castaño nature nogal

Solamente está disponible sin tirador o con tip-on, no es posible realizar ninguna perforación para colocar tiradores.

F3 **Striped brushed**

Frente: Rechapado de roble/castaño sobre base de MDF (DM) negro, con alistonado vertical. La parte trasera es lisa del mismo acabado. La distancia entre listones es de 5 mm.

BLACK STRIPE V	Color de frente	Carcasa	Costado visto	Costados decorativos	XW5/ XW6	Zócalos	Estantes
P622 121	castaño	*	F3/*1	F3/*2	-	F3	F3
P622 102	nature	*	F3/*1	F3/*2	-	F3	F3
P622 216	nogal	*	F3/*1	F3/*2	-	F3	F3

Anotación:

F3/*1 Los costados decorativos (paneles) son alistonados, el canto es liso del color del frente, el panel trasero es liso color negro.

F3/*2 Los costados decorativos de 19 mm pueden ser ranurados en una cara (OLWR) o lisos (OLW). El canto es liso del color del frente. Los costados de grosores especiales (50, 75 o 100 mm) solo están disponibles en acabado liso (OLW).

En el sistema de gola **GLV-45** el MDF (DM) negro está visible en el canto superior

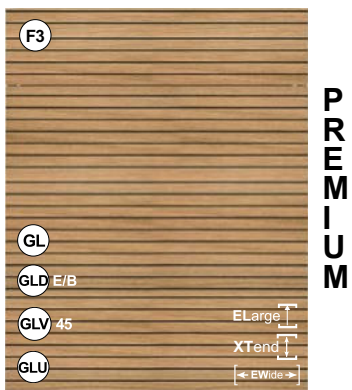

Vitrinas
G / GA / GM / R Puerta de vidrio con marco



nature

F3 (anteriormente BLACK-LINE) **Striped brushed**

Frente: Rechapado de madera de roble sobre base de MDF (DM) negro, reverso rechapado de roble liso.

BLACK-LINE	Color de frente	Carcasa	Costado visto	Costados decorativos	XW5/ XW6	Zócalos	Estantes
P623 102	nature	negro	F3/*1	F3/*2	-	F3	F3

Anotación:

F3/*1 los costados vistos se suministran con ranurado en la cara vista. El canto frontal no lleva ranurado.

El reverso del costado visto es negro.

F3/*2 Los costados de 19 y 50 mm: se suministran con un frente y el canto ranurados. No están disponibles costados de 75 ni 100 mm!

Atención!

- Con los sistemas de apertura GLV45, GLU y GLX90 el DM negro es visible en la zona del perfil
- Debido a la continuidad del ranurado horizontal, no se pueden combinar las gamas GL78 y S126 (Por ejemplo columnas con gola vertical con muebles bajos con gola GL!)
- Los frentes o puertas a medida no llevan las perforaciones para los tiradores realizadas de fábrica

Configuración de posiciones de tirador

BLACK-LINE F3 (solamente compatible con tiradores 466/467/470)



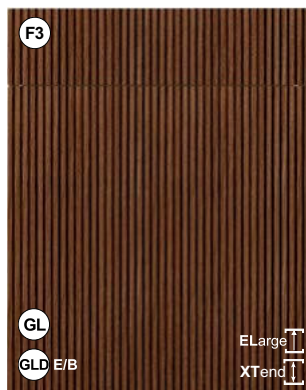

PREMIUM

Vitrinas
Solo vitrinas universales disponibles

F3 (anteriormente NOTCHO)

Striped brushed

Frente: rechapado mecanizado verticalmente (roble: natural y negro; nogal: nogal), sobre tablero de aglomerado y doble soporte de MDF (DM), grosor de 20 mm, reverso rechapado del mismo color.

NOTCHO	Color de frente	Carcasa	Costado visto	Costados decorativos	XW5/XW6	Zócalos	Estantes
P624 022	negro	KS	F3/*1	F3/*2	-	F3	F3
P624 102	nature	*	F3/*1	F3/*2	-	F3	F3
P624 216	nogal	*	F3/*1	F3/*2	-	F3	F3
RAL							
P625 000	RAL-, Sikkens-, NCS	*	F3/*1	F3/*2	-	F3	F3



negro nature nogal



Colores RAL, Sikkens, NCS

La posibilidad de lacado en carta de color solo está disponible para cocinas completas. En pedidos pequeños hasta 10 puertas, se valorará bajo demanda y con suplemento. No disponibles colores metálicos!

Anotación:

Costado visto F3/*1: solamente disponible liso
Costados F3/*2 de 19 solamente disponibles con ranurado en un frente (OLWR, 20 mm de grosor) lisas en las dos caras (OLW)
Paneles de 50-100 mm solo disponibles en acabado liso

Solamente está disponible sin tirador o con tip-on, no es posible realizar ninguna perforación para colocar tiradores.



PREMIUM

Vitrinas
R Vitrina con marco cuadrado,
H Puerta de madera en la parte inferior, con vidrio en alto

F1 (anteriormente ORBITA)

Knotty raw

Frente: Marco de 11 cm de madera de roble maciza rústica, arenada, con panel central rechapado, reverso rechapado del mismo color.

ORBITA	Frontkleur	Corps	Zichtzijde	Vlak	XW5/XW6	Plinten	Open kasten
P442 019	beachwood	*	F1	F1/*	-	F1	F2
P442 031	driftwood	*	F1	F1/*	-	F1	F2
P442 102	nature	*	F1	F1/*	-	F1	F2
RAL							
P443 000	RAL-, Sikkens-, NCS	*	F1	F1/*	-	F1	F2

Los estantes solo están disponibles en F2 cepillado



beachwood driftwood nature



Colores RAL, Sikkens, NCS

La posibilidad de lacado en carta de color solo está disponible para cocinas completas. En pedidos pequeños hasta 10 puertas, se valorará bajo demanda y con suplemento. No disponibles colores metálicos!

F1/* Para este acabado, hay disponibles costados lisos (OLW) o ranurados de los siguientes (OLWR) grosores: 19,50,75 y 100 mm.

Atención!

En anchuras inferiores a 30 cm, el frente es liso (sin marco) geleverd.

Se deben solicitar frentes y puertas RAL dentro de los siguientes 6 meses desde el pedido, a fin de evitar diferencias menores de color.

Configuración de posiciones de tirador

ORBITA F1

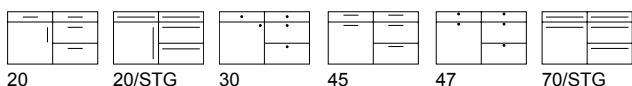



PREMIUM

Vitrinas

R Vitrina con marco cuadrado,
H Puerta de madera en la parte inferior, con vidrio en alto



beachwood driftwood nature



Colores RAL, Sikkens, NCS

La posibilidad de lacado en carta de color solo está disponible para cocinas completas. En pedidos pequeños hasta 10 puertas, se valorará bajo demanda y con suplemento. No disponibles colores metálicos!

F1 (anteriormente RIPIENO) Knotty raw

Frente: Marco de 11 cm de madera de roble maciza rústica, arenada, con panel central macizo, reverso rechapado del mismo color.

RIPIENO	Color de frente	Carcasa	Costado visto	Costados decorativos	KL/LL	Zócalos	Estantes
P541 019	beachwood	*	F1	F1/*	-	F1	F2
P541 031	driftwood	*	F1	F1/*	-	F1	F2
P541 102	nature	*	F1	F1/*	-	F1	F2
RAL							
P542 000	RAL-, Sikkens-, NCS	*	F1	F1/*	-	F1	F2

Los estantes solo están disponibles en F2 **cepillado**

F1/* Para este acabado, hay disponibles costados lisos (OLW) o ranurados de los siguientes (OLWR) grosores: 19,50,75 y 100 mm.

Atención!

En anchuras inferiores a 30 cm, el frente es liso (sin marco). Los frentes de cajones y gaveteros de altura inferior a 352 mm se sirven con el panel central liso.

Configuración de posiciones de tirador

RIPIENO F1

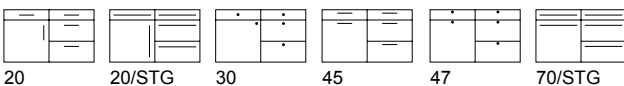

20

20/STG

30

45

47

70/STG



Tiradores, encimeras,
tablas de acabados,
modelos descatalogados

Tiradores | Pomos

Tiradores/Pomos	Nr.	Información	Tiradores/Pomos	Nr.	Información
	200	Cromado/mate, 160 mm GRIBO: 10 - 15 - 20 - 40 - 45		385	negro con textura, 160 mm longitud total 188 mm GRIBO: 10 - 15 - 20 - 40 - 45
	222	Inox fino, 192 mm GRIBO: 10 - 15 - 20 - 40 - 45		386	Negro, 160 mm longitud total 181 mm GRIBO: 10 - 15 - 20 - 40 - 45
	270	Níquel mate cepillado, 128 mm GRIBO: 10 - 15 - 20 - 40 - 45		392	Inox, 160 mm GRIBO: 10 - 15 - 20 - 40 - 45
	279	Zinc, 128 mm GRIBO: 10 - 15 - 20 - 40 - 45		393	Negro mate, 160 mm GRIBO: 10 - 15 - 20 - 40 - 45
	285	Óptica inox, 160 mm MP ● GRIBO: 10 - 15 - 20 - 40 - 45		394	rosa dorado, 160 mm GRIBO: 10 - 15 - 20 - 40 - 45
	289	Anticato, 224 mm está disponible en distintos acabados (no disponible para anchuras inferiores a 300 mm) MP En todos los grupos de precio ● GRIBO: 10 - 15 - 20 - 40 - 45		396	Gris Piedra, 160 mm longitud total 260 mm GRIBO: 40 - 45
	297	Óptica inox, 128 mm GRIBO: 10 - 15 - 20 - 40 - 45		397	Gris Piedra, 320 mm longitud total 419 mm con el tirador 396 para longitudes superiores a 600 mm MP GRIBO: 40 - 45
	298	Acabado inox, 192 mm longitud total 230 mm GRIBO: 10 - 15 - 20 - 40 - 45		413	Marrón envejecido, 192 mm MP ● GRIBO: 10 - 15 - 20 - 40 - 45
	299	Óptica inox, 128 mm ● GRIBO: 10 - 15 - 20 - 40 - 45		414	Marrón envejecido, 288 mm se combina con tirador 413 el modelo 414 se utiliza a partir de anchuras de 600 mm MP ● GRIBO: 40 - 45
	384	Negro, 160 mm longitud total 206 mm GRIBO: 10 - 15 - 20 - 40 - 45		421	Óptica inox, 160 mm ● GRIBO: 10 - 15 - 20 - 40 - 45

Acabados en melamina

Acabados mates

















Acabados brillantes

Acabados polilaminados

Wood Range + Wood Specials

Tiradores, encimeras, tablas de acabados, modelos descatalogados

Tiradores | Pomos

Tiradores/Pomos	Nr.	Información	Tiradores/Pomos	Nr.	Información
	422	Óptica inox, 320 mm se combina con el tirador 421 a partir de anchuras de 600 mm MP ● GRIBO: 40 - 45		461	Negro mate, 192 mm longitud total 200 mm GRIBO: 10 - 15 - 20 - 40 - 45
	423	latón cepillado, 160 mm anchura total 170 mm ● GRIBO: 10 - 15 - 20 - 40 - 45		506	Tirador en barra versión corta, (STGE Inox, siempre 184 mm) longitud total 226 mm MP ● GRIBO: 10 - 15 - 20 - 40 - 45
	424	Negro, 160 mm longitud total 200 mm MP GRIBO: 10 - 15 - 20 - 40 - 45		507	Tirador en barra versión corta, (STGE negro, siempre 184 mm) longitud total 226 mm MP ● GRIBO: 10 - 15 - 20 - 40 - 45
	435	Negro mate, 160 mm longitud total 170 mm ● GRIBO: 10 - 15 - 20 - 40 - 45			
	436	Negro mate lacado, 192 mm longitud total 199 mm MP GRIBO: 10 - 15 - 20 - 40 - 45		314	Pomo, negro lacado, 16 mm Perforacion verical no es posible! ● GRIBO: 40 - 45
	437	Negro mate Lacado pulverizado, 128 mm longitud total 164 mm GRIBO: 10 - 15 - 20 - 40 - 45		372	Pomo anticato está disponible en distintos acabados MP ● GRIBO: 30 - 47
	438	metall oscuro con soldaduras, 160 mm longitud total 175 mm MP En todos los grupos de precio ● GRIBO: 10 - 15 - 20 - 40 - 45		373	Pomo inox ● GRIBO: 30 - 47
	439	metall oscuro con soldaduras, 320 mm, longitud total 335 mm solamente se puede combinar con el tirador 438 para longitudes superiores a 600 mm MP En todos los grupos de precio ● GRIBO: 40 - 45			
	452	Negro envejecido, 160 mm GRIBO: 10 - 15 - 20 - 40 - 45			
	453	Óptica inox, 192 mm ● GRIBO: 10 - 15 - 20 - 40 - 45			



466 Tirador negro cepillado
GRIBO: 10 - 15 - 20 - 40 - 45

467* Distancia entre perforaciones 160 mm
 Longitud 225 mm / *375 mm,
 espacio interior de 130 mm.
 Tiene la misma dimensión para todas
 las anchuras de puerta

MP ●

GRIBO: 40 - 45 a partir de anchuras
de 450 mm

470 Tirador - en función de las anchuras de las puertas:
 466 Tirador de 225 mm (para anchuras de 300 y 400 mm)
 467 Tirador de 375 mm (para anchuras de 450 a 500 mm)
 468 Tirador de 525 mm (para anchuras a partir de 800 mm)
 469 Tirador de 825 mm (para anchuras de 900 a 1200 mm)

MP ●

GRIBO: 40 - 45







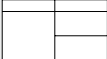

Para los modelos con marco, las perforaciones para los tiradores se realizarán verticalmente. No es posible realizarlas horizontalmente!

MP = Los tiradores se pueden suministrar con coste extra en cualquier grupo de precio.
 ● = **Se recomienda la solución** para rincones en „L“ de 700 x 700 mm a fin de garantizar la correcta apertura de las puertas.

LOS TIRADORES EN BARRA Y LOS QUE SE COLOCAN MECANIZADOS EN EL MUEBLE SIEMPRE LLEVAN SOBRECOSTE EN TODOS LOS GRUPOS DE PRECIO.

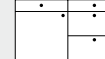
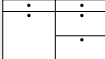
Tiradores en barra	Nr.	Información
	STGE	Inox MP ●
		GRIBO: 20/STG - 70/STG
	STGEB	Revestido en negro MP ●
		GRIBO: 20/STG - 70/STG
	STGBIG	Negro MP ●
		GRIBO: 20/STG - 70/STG

GRIBO - Posibilidades de perforaciones para tiradores

						
GRIBO 1 sin perforación	GRIBO 10 horizontal	GRIBO 15 horizontal, en alto	GRIBO 20 vertical	GRIBO 20/STG	GRIBO 30 pomo	GRIBO 31 pomo centrado
						
GRIBO 40 centrado Solo disponible para puertas lisas.	GRIBO 45 centrado, en alto	GRIBO 47 pomo centrado, en alto	GRIBO 70/STG barra horizontal			



08 COM 995
negro



09 COM 996
inox



10 COM 997
inox



11 COM 994
negro



WALL 920
negro

Anotación:

- Suplementos por tirador
- Para muebles bajos, utilizar los números de artículo de la lista S126
- Para muebles bajos, utilizar los números de artículo de la lista GL780 (XH)
- Para las columnas, utilizar los números de artículo de la lista S126
- Las puertas abatibles sobre columnas se abren siempre con Tip-On
- Se utiliza un tirador especial para los frigoríficos
- Atención!** Solo ciertos modelos de frigorífico de doble puerta son compatibles debido a la instalación del perfil entre las dos puertas.

Los siguientes elementos no están disponibles:

- Un frente de 256 mm bajo una columna o mueble bajo no puede tener una estructura interior de gavetero sino solamente de cajón
- UAG 45/60 26 et UGG 45/60 39 - el extraíble se abre desde la parte inferior (base recortada)
- El modelo U2AG 45/60 52 no está disponible
- El modelo UE 83/93 78/91 no está disponible
- Es necesario para los modelos angulares USPV..., UV..., GV4L..., AGV2l... entregar un plano con el diseño exacto
- Los modelos GEL..., GGEL..., GGEL2..., GKL... no están disponibles



- | | | | | |
|-----------|---|-----------|-----------|-----------|
| 01 | GL-E/B sin tirador, metálico inox o metálico negro | NL | LL | PL |
| 02 | GLD-E/B sin tirador, acabado seleccionado con perfil metálico inox o metálico negro | NL | LL | PL |
| 03 | GLV-E/B sin tirador, puerta recortada a 45° con perfil metálico inox o metálico negro a 45° | | | PL |
| 04 | GLX-E sin tirador, puerta mecanizada a 90° con perfil metálico 90° | | | PL |
| 05 | GLV-45 sin tirador, puerta recortada a 45° y finalizada | | | PL |
| 06 | GLX-90 sin tirador, puerta recortada a 90° y finalizada | | | PL |
| 07 | GLU sin tirador, puerta con mecanizado en forma de U | | | PL |

Colores de la encimera



1000 ALPINWEISS



1001 ANTHRAZIT SOLID COLOR



1002 ARKOSA SAND



1003 ARLINTON EICHE



1009 BETON ART PERLGRAU



1010 BETON DUNKEL



1011 BETON HELL



1012 BETON NATUR



1013 BLOCK BOARD NOCHE



1015 BORDOLINO EICHE GRAU



1017 CERAMIC ANTHRAZIT



1018 CERAMICO ROST



1019 CHROMIX ANTHRAZIT

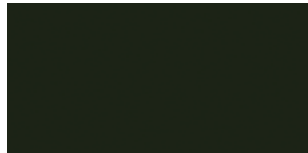

1025 DARK NIGHT



1031 EICHE SANREMO SAND



1033 FLASH BLACK



1034 GLADSTONE OAK GREIGE

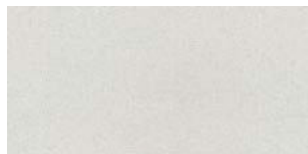

1036 GLITTERSTONE LIGHT



1037 GRAPHITGRAU, ORION



1039 HALIFAX EICHE WEISS



1041 ICY WHITE SOLID COLOR

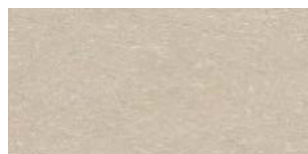

1043 JURAMARMOR



1047 KUPFER



1049 LICHTGRAU



1053 METALLO GRAUBRAUN



1054 METALLSCHWARZ



1060 NATURAL LANCELOT OAK

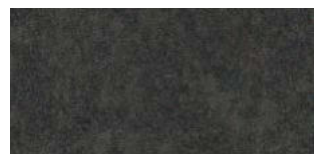

1062 NEGRO BRASIL



1068 PALE LANCELOT OAK



1069 PAPYRUS NUBIA BRAUN



1072 RAJA BLACK



1077 SANDGRAU



1095 TIVOLI



1100 VICENZA EICHE HELL



1104 WEISS STEINSTRUKTUR



1107 DELFÍN

Colores de la encimera



1108 PIZARRA



1109 HALIFAX EICHE NATUR



1110 CRUSH GOLD



1111 HALIFAX CRACK OAK



1150 CARBÓN



1160 GRAVA



1180 KITO BLAUSTAHL

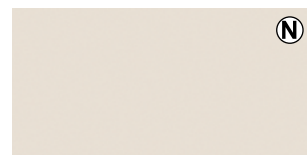

1181 SHELL



1182 WARMIA NUSSBAUM, NOGAL



5001 FENIX BIANCO



5002 FENIX BIANCO ALASKA

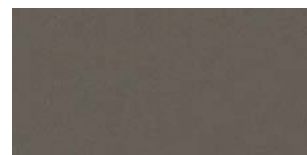

5003 FENIX GRIGIO LONDA

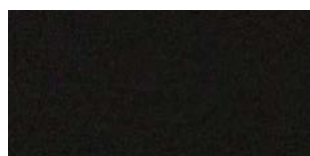

5004 FENIX NERO



5005 FENIX BIANCO KOS



6000 EXTREM CARBON



6001 EXTREM EDELWEISS



6002 EXTREM ICY WHITE



6003 EXTREM KASHMIRGRAU

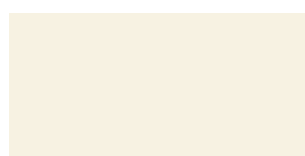

6008 EXTREM MAGNOLIENWEISS

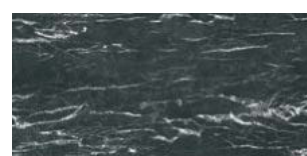

6009 EXTREM MARMOR SCHWARZ



6010 EXTREM MARMOR WEISS



6013 EXTREM SHARKY GREY



6014 EXTREM SNOW/KREIDE

Acabados en melamina

Acabados mates

Acabados brillantes

Acabados polilaminados

Wood Range + Wood Specials

Tiradores, encimeras, tablas de acabados, modelos descatalogados

Colores de la encimera

Código Art.	Nombre del acabado	ID	40 mm RK	40/60/100 mm SK	16 + 40 mm PP	Color de frente idéntico	Color de carcasa idéntico	Longitud max. en mm	Frontal del mismo color
1000	ALPINWEISS	1025	+	+	+	bianco	bianco	5000	+
1001	ANTHRAZIT SOLID COLOR	1290	-	+	+			4000	+
1002	ARKOSA SAND	276	+	+	+			5000	+
1003	ARLINTON EICHE	H3303	-	+	+	roble natural	roble natural	4000	+
1009	BETON ART PERLGRAU	44375	-	+	+	oxyde claro		4000	+
1010	BETON DUNKEL	275	+	+	+			5000	+
1011	BETON HELL	274	+	+	+			5000	+
1012	BETON NATUR	34149	-	+	+			4000	+
1013	BLOCK BOARD NOCHE	4206	+	+	+			5000	+
1015	BORDOLINO EICHE GRAU	1146	+	+	+	roble bardolino		5000	+
1017	CERAMIC ANTHRAZIT	311	+	+	+			5000	+
1018	CERAMICO ROST	6008	+	+	+			5000	+
1019	CHROMIX ANTHRAZIT	641	+	+	+			5000	+
1025	DARK NIGHT	901	-	+	+	negro	negro	4000	+
1031	EICHE SANREMO SAND	34139	-	+	+	roble sanremo		4000	+
1033	FLASH BLACK	7654	+	+	+			5000	+
1034	GLADSTONE OAK GREIGE	3326	+	+	+			5000	+
1036	GLITTERSTONE LIGHT	7655	+	+	+			5000	+
1037	GRAPHITGRAU	1257	-	+	+	orion	orion	5000	+
1039	HALIFAX EICHE WEISS	H1176	-		+	blanco Halifax		4000	+
1041	ICY WHITE SOLID COLOR	1027	-	+	+	optiwhite	optiwhite	4000	+
1043	JURAMARMOR	6442	+	+	+			5000	+
1047	KUPFER	3236	+	+	+			5000	+
1049	LICHTGRAU	1188	+	+	+	grigio	grigio	5000	+
1053	METALLO GRAUBRAUN	633	+	+	+			5000	+
1054	METALLSCHWARZ	1233	+	+	+	grafito	grafito	5000	+
1060	NATURAL LANCELOT OAK	4263	+	+	+	sherwood natural		5000	+
1062	NEGRO BRASIL	6216	-	+	+			5000	+
1068	PALE LANCELOT OAK	4262	+	+	+			5000	+
1069	PAPYRUS NUBIA BRAUN	22008	+	+	+			5000	+
1072	RAJA BLACK	3505	+	+	+			5000	+
1077	SANDGRAU	1184	+	+	+			5000	+
1095	TIVOLI	6244	+	+	+			5000	+
1100	VICENZA EICHE HELL	H3157	-	+	+	vicenza oak claire		4000	+
1104	WEISS STEINSTRUKTUR	0179	-	+	+	optiwhite	optiwhite	5000	+
1107	DELFIN	U12044	-	+	+	delfin	delfin	5000	+
1108	PIZARRA	U12986	-	+	+	pizarra	pizarra	5000	+
1109	HALIFAX EICHE NATUR	H1180	-	+	+	natural Halifax		5000	+
1110	CRUSH GOLD	F442	-	+	+	acabado dorado		5000	+
1111	HALIFAX CRACK OAK	H3183	-	+	+	halifax crack oak	halifax crack oak	5000	+
1150	CARBÓN	U201	-	+	+	carbón	carbón	5000	+
1160	GRAVA	U968	-	+	+	grava	grava	5000	+
1180	KITO BLAUSTAHL	FG76111	-	+	+	acero azul		5000	+
1181	SHELL	705	-	+	+	shell	shell	5000	+
1182	WARMIA NUSSBAUM	1307	-	+	+	nogal	nogal	5000	+

Acabados FENIX

5001	FENIX BIANCO	29	-	+	FE	bianco	bianco	4000	+
5002	FENIX BIANCO ALASKA	30	-	+	FE	optiwhite	optiwhite	4000	+
5003	FENIX GRIGIO LONDA	718	-	+	FE	londra		4000	+
5004	FENIX NERO	720	-	+	FE	negro	negro	4000	+
5005	FENIX BIANCO KOS	0032	-	+	FE	blanco kos	bianco	4000	+

Colores de la encimera

Código Art.	Nombre del acabado	ID	40 mm RK	40/60/100 mm SK	16 + 40 mm PP	Color de frente idéntico	Color de carcasa idéntico	Longitud max. en mm	Frontal del mismo color
Acabados EXTREM									
6000	EXTREM CARBON	U1233 XM	-	+	XM	grafito	grafito	4000	+
6001	EXTREM EDELWEISS	SR209 XM	-	+	XM			4000	+
6002	EXTREM ICY WHITE	U1027 XM	-	+	XM	optiwhite	optiwhite	4000	+
6003	EXTREM KASHMIRGRAU	U1168 XM	-	+	XM	cachemir	cachemir	4000	+
6008	EXTREM MAGNOLIENWEISS	U1379 XM	-	+	XM	magnolia	magnolia	4000	+
6009	EXTREM MARMOR SCHWARZ	S63028	-	+	XM			4000	+
6010	EXTREM MARMOR WEISS	S63009	-	+	XM			4000	+
6013	EXTREM SHARKY GREY	U091 XM	-	+	XM	sharky	sharky	4000	+
6014	EXTREM SNOW/KREIDE	U102 XM	-	+	XM	snow	snow	4000	+

FE Estratificado Fénix (Precio especial: ver lista de precios), **PP** Canto-PP, **RK** Postformada **SK** Canto estratificado, **WAP** Frontal, **XM** Estratificado Extrem (Precio especial: ver lista de precios)

Encimeras XM

- Estratificado decorativo de alta presión, con superficie resistente, endurecida con tratamiento de electrones y pulido inferior.
- Textura y acabado ultramate para frontales y encimeras con todas las cualidades y resistencias de un laminado de alta presión (HPL).
- Tacto cálido y sedoso, invita al contacto.
- resistente a huellas y grasa, para garantizar una óptima utilización diaria.
- Gran facilidad de limpieza, permitiendo retirar sin esfuerzo las impurezas diarias, y especialmente las manchas de grasa.

Importante:

Con el fin de prolongar al máximo la vida útil de la encimera se recomienda leer las siguientes anotaciones:

- La superficie Xtreme no es insensible al rayado.
- En acabados oscuros especialmente, cortes directos y arañazos pueden dejar marcas perennes.

Marcas y arañazos producidos por usos inadecuados (vajilla dañada, corte directo sobre la encimera,...) no suponen motivo de reclamación.

Tabla de acabados en melamina

PREMIUM LINE

KS polilaminado	Carcasa	Costado visto	W 19	WR 19	W 50	W 100	Pilastras	XW5/ XW6	Zócalos	Estantes	
arcai-red	(N) -	•	•	-	-	•	-	•	•	-	*OZ14/15 OZ36/37 OZ53/54
bianco	KS	-	•	•	-	•	K	-	•	•	K Pilastra de polilaminado
negro	KS	-	•	-	-	-	-	-	•	•	
blackblue	(N) -	•	•	-	-	•	-	•	•	-	
blackgreen	(N) -	•	•	-	-	•	-	•	•	-	
carbón	KS	-	•	-	•	•	-	•	•	•	
delfín	KS	-	•	-	•	•	-	•	•	•	
fango	-	•	•	-	•	•	-	•	•	•	
grafito	KS	-	•	-	-	-	-	-	•	•	
grigio	KS	-	•	-	•	•	-	•	•	•	
cachemir	KS	-	•	•	•	•	K	•	•	•	
grava	KS	-	•	-	•	•	-	•	•	•	
magnolia	KS	-	•	•	-	•	K	-	•	•	
musgo	-	•	•	-	-	•	-	•	•	-	
muscata	-	•	•	-	•	•	-	•	•	•	
optiwhite	KS	-	•	-	•	•	-	•	•	•	
orion	(N) KS	-	•	-	•	•	-	•	•	•	
sharky	KS	-	•	-	•	•	-	•	•	•	
shell	(N) KS	-	•	-	•	•	-	•	•	•	
pizarra	KS	-	•	-	•	•	-	•	•	•	
snow	KS	-	•	-	-	-	-	-	•	•	
stormgrey	(N) -	•	•	-	-	•	-	•	•	-	

Tabla de acabados en melamina

LITE LINE

KS polilaminado	Carcasa	Costado visto	W 19	WR 19	W 50	W 100	Pilastras	XW5/ XW6	Zócalos	Estantes
arcai-red	(N) -	•	•	-	-	•	-	•	•	-
bianco	KS	-	•	-	-	-	-	-	•	•
blackblue	(N) -	•	•	-	-	•	-	•	•	-
blackgreen	(N) -	•	•	-	-	•	-	•	•	-
carbón	KS	-	•	-	•	•	-	•	•	•
delfín	KS	-	•	-	•	•	-	•	•	•
fango	-	•	•	-	•	•	-	•	•	•
grigio	-	•	•	-	•	•	-	•	•	•
cachemir	-	•	•	-	•	•	-	•	•	•
grava	-	•	•	-	•	•	-	•	•	•
magnolia	-	-	•	-	-	-	-	-	•	•
musgo	-	•	•	-	-	•	-	•	•	-
muscata	-	•	•	-	•	•	-	•	•	•
optiwhite	-	•	•	-	•	•	-	•	•	•
orion	(N) -	•	•	-	•	•	-	•	•	•
sharky	-	•	•	-	•	•	-	•	•	•
shell	(N) -	•	•	-	•	•	-	•	•	•
pizarra	KS	-	•	-	•	•	-	•	•	•
snow	-	-	•	-	-	-	-	-	•	•
stormgrey	(N) -	•	•	-	-	•	-	•	•	-

NEW LINE

KS polilaminado	Carcasa	Costado visto	W 19	WR 19	W 50	W 100	Pilastras	XW5/ XW6	Zócalos	Estantes
arcai-red	(N) -	•	•	-	-	-	-	•	•	-
bianco	KS	-	•	-	-	-	-	-	•	•
blackblue	(N) -	•	•	-	-	-	-	•	•	-
blackgreen	(N) -	•	•	-	-	-	-	•	•	-
carbón	KS	-	•	-	-	-	-	•	•	•
delfín	KS	-	•	-	-	-	-	•	•	•
fango	-	•	•	-	-	-	-	•	•	•
grigio	-	•	•	-	-	-	-	•	•	•
cachemir	-	•	•	-	-	-	-	•	•	•
grava	-	•	•	-	-	-	-	•	•	•
magnolia	-	-	•	-	-	-	-	-	•	•
musgo	-	•	•	-	-	-	-	•	•	-
muscata	-	•	•	-	-	-	-	•	•	•
optiwhite	-	•	•	-	-	-	-	•	•	•
orion	(N) -	•	•	-	-	-	-	•	•	•
sharky	-	•	•	-	-	-	-	•	•	•
shell	(N) -	•	•	-	-	-	-	•	•	•
pizarra	KS	-	•	-	-	-	-	•	•	•
snow	-	-	•	-	-	-	-	-	•	•
stormgrey	(N) -	•	•	-	-	-	-	•	•	-

PREMIUM LINE

WL Woodline	Carcasa	Costado visto	W 19	WR 19	W 50	W 100	Pilastras	XW5/ XW6	Zócalos	Estantes
bianco	KS	•	•	-	•	•	-	•	•	•
black burned	(N) -	•	•	-	-	•	-	•	•	-
roble denver	-	•	•	-	-	•	-	•	•	-
roble bardolino	-	•	•	-	•	•	-	•	•	•
roble natural	KS	-	•	-	•	•	-	•	•	•
roble sanremo	-	•	•	-	•	•	-	•	•	•
vicenza oak claire	-	•	•	-	•	•	-	•	•	•

LITE LINE

WL Woodline	Carcasa	Costado visto	W 19	WR 19	W 50	W 100	Pilastras	XW5/ XW6	Zócalos	Estantes
bianco	KS	•	•	-	•	•	-	•	•	•
black burned	(N) -	•	•	-	-	•	-	•	•	-
roble bardolino	-	•	•	-	•	•	-	•	•	•
roble denver	-	•	•	-	-	•	-	•	•	-
roble natural	-	•	•	-	•	•	-	•	•	•
roble sanremo	-	•	•	-	•	•	-	•	•	•
vicenza oak claire	-	•	•	-	•	•	-	•	•	•

Tabla de acabados en melamina

NEW LINE

WL Woodline	Carcasa	Costado visto	W 19	WR 19	W 50	W 100	Pilastras	XW5/ XW6	Zócalos	Estantes
bianco	KS	•	•	-	-	-	-	•	•	•
black burned	(N) -	•	•	-	-	-	-	•	•	-
denver-oak	-	•	•	-	-	-	-	•	•	-
roble bardolino	-	•	•	-	-	-	-	•	•	•
roble natural	-	•	•	-	-	-	-	•	•	•
roble sanremo	-	•	•	-	-	-	-	•	•	•
vicenza oak claire	-	•	•	-	-	-	-	•	•	•

PREMIUM LINE

ST Estructur. imitando madera	Carcasa	Costado visto	W 19	WR 19	W 50	W 100	Pilastras	XW5/ XW6	Zócalos	Estantes
amber	-	•	•	-	-	•	-	•	•	•
argento	-	•	•	-	•	•	-	•	•	•
basalt oscuro	-	•	•	-	-	•	-	•	•	•
negro (Albero)	(N) KS	•	•	-	-	•	-	•	•	•
negro (Cemento)	KS	•	•	-	-	•	-	•	•	•
negro (Feelwood)	(N) KS	•	•	-	-	•	-	•	•	•
negro (Metall)	KS	•	•	-	-	•	-	•	•	•
bronce	-	•	•	-	-	•	-	•	•	•
marrón	-	•	•	-	-	•	-	•	•	•
café	(N) -	•	•	-	-	•	-	•	•	•
halifax crack oak	KS	-	•	-	•	•	-	•	•	•
natural Halifax	-	•	•	-	•	•	-	•	•	•
halifax tin dark	(N) -	•	•	-	-	•	-	•	•	•
blanco Halifax	-	•	•	-	•	•	-	•	•	•
roble nudoso	-	•	•	-	•	•	-	•	•	•
gris claro	-	•	•	-	-	•	-	•	•	•
nature	(N) -	•	•	-	-	•	-	•	•	•
noce	(N) -	•	•	-	-	•	-	•	•	•
oxyde claro	-	•	•	-	-	•	-	•	•	•
sherwood negro	KS	•	•	-	-	•	-	•	•	•
sherwood burned wood	-	•	•	-	-	•	-	•	•	-
sherwood bushy park	-	•	•	-	-	•	-	•	•	•
sherwood cigar	-	•	•	-	-	•	-	•	•	•
sherwood engadina	-	•	•	-	-	•	-	•	•	•
sherwood graphit	KS	•	•	-	-	•	-	•	•	•
sherwood greenwich	-	•	•	-	-	•	-	•	•	•
sherwood natural	-	•	•	-	-	•	-	•	•	•
acero oscuro	-	•	•	-	-	•	-	•	•	•
acero azul	-	•	•	-	-	•	-	•	•	•
umbra claro	-	•	•	-	-	•	-	•	•	•
nogal	(N) KS	-	•	-	•	•	-	•	•	•

Tabla de acabados en melamina

LITE LINE

ST Estruct. imitando madera	Carcasa	Costado visto	W 19	WR 19	W 50	W 100	Pilastras	XW5/ XW6	Zócalos	Estantes
amber	-	•	•	-	-	•	-	•	•	•
argento	-	•	•	-	•	•	-	•	•	•
basalt oscuro	-	•	•	-	-	•	-	•	•	•
negro (Albero) (N)	-	•	•	-	-	•	-	•	•	•
negro (Cemento)	-	•	•	-	-	•	-	•	•	•
negro (Feelwood)	-	•	•	-	-	•	-	•	•	•
negro (Metall)	-	•	•	-	-	•	-	•	•	•
bronce	-	•	•	-	-	•	-	•	•	•
marrón	-	•	•	-	-	•	-	•	•	•
café (N)	-	•	•	-	-	•	-	•	•	•
halifax crack oak	-	•	•	-	•	•	-	•	•	•
natural Halifax	-	•	•	-	•	•	-	•	•	•
halifax tin dark (N)	-	•	•	-	-	•	-	•	•	•
blanco Halifax	-	•	•	-	•	•	-	•	•	•
roble nudoso	-	•	•	-	•	•	-	•	•	•
gris claro	-	•	•	-	-	•	-	•	•	•
nature (N)	-	•	•	-	-	•	-	•	•	•
noce (N)	-	•	•	-	-	•	-	•	•	•
oxyde claro	-	•	•	-	-	•	-	•	•	•
sherwood black	-	•	•	-	-	•	-	•	•	•
sherwood burned wood	-	•	•	-	-	•	-	•	•	-
sherwood bushy park	-	•	•	-	-	•	-	•	•	•
sherwood cigar	-	•	•	-	-	•	-	•	•	•
sherwood engadina	-	•	•	-	-	•	-	•	•	•
sherwood grafito	-	•	•	-	-	•	-	•	•	•
sherwood greenwich	-	•	•	-	-	•	-	•	•	•
sherwood natural	-	•	•	-	-	•	-	•	•	•
acero oscuro	-	•	•	-	-	•	-	•	•	•
acero azul	-	•	•	-	-	•	-	•	•	•
umbra claro	-	•	•	-	-	•	-	•	•	•
nogal (N)	-	•	•	-	•	•	-	•	•	•

NEW LINE

ST Estruct. imitando madera	Carcasa	Costado visto	W 19	WR 19	W 50	W 100	Pilastras	XW5/ XW6	Zócalos	Estantes
amber	-	•	•	-	-	-	-	•	•	•
argento	-	•	•	-	-	-	-	•	•	•
basalt oscuro	-	•	•	-	-	-	-	•	•	•
negro	-	•	•	-	-	-	-	•	•	•
bronce	-	•	•	-	-	-	-	•	•	•
halifax crack oak	-	•	•	-	-	-	-	•	•	•
halifax nature	-	•	•	-	-	-	-	•	•	•
halifax tin dark (N)	-	•	•	-	-	-	-	•	•	•
blanco Halifax	-	•	•	-	-	-	-	•	•	•
roble nudoso	-	•	•	-	-	-	-	•	•	•
gris claro	-	•	•	-	-	-	-	•	•	•
oxyde claro	-	•	•	-	-	-	-	•	•	•
steelblue	-	•	•	-	-	-	-	•	•	•
nogal (N)	-	•	•	-	-	-	-	•	•	•

PREMIUM LINE

ES Acero inoxidable	Carcasa	Costado visto	W 19	WR 19	W 50	W 100	Pilastras	XW5/ XW6	Zócalos	Estantes
acero inoxidable	-	-	-	-	-	-	-	-	•	-

Tabla de acabados mates

PREMIUM LINE

UM Ultra mate	Carcasa	Costado visto	W 19	WR 19	W 50	W 100	Pilastras	XW5/ XW6	Zócalos	Estantes
bianco	KS	•	•	-	-	•	-	•	•	•
magnolia	KS	•	•	-	-	•	-	•	•	•
snow	KS	•	•	-	-	•	-	•	•	•

LITE LINE

UM Ultra mate	Carcasa	Costado visto	W 19	WR 19	W 50	W 100	Pilastras	XW5/ XW6	Zócalos	Estantes
bianco	KS	•	•	-	-	•	-	•	•	•
magnolia	-	•	•	-	-	•	-	•	•	•
snow	-	•	•	-	-	•	-	•	•	•

NEW LINE

UM Ultra mate	Carcasa	Costado visto	W 19	WR 19	W 50	W 100	Pilastras	XW5/ XW6	Zócalos	Estantes
bianco	KS	•	•	-	-	-	-	•	•	•
magnolia	-	•	•	-	-	-	-	•	•	•
snow	-	•	•	-	-	-	-	•	•	•

PREMIUM LINE

SM Estratificado mate	Carcasa	Costado visto	W 19	WR 19	W 50	W 100	Pilastras	XW5/ XW6	Zócalos	Estantes
bianco	KS	•	•	-	•	•	-	•	•	•
bianco kos	KS	•	•	-	•	•	-	•	•	•
magnolia	KS	•	•	-	•	•	-	•	•	•
optiwhite	KS	•	•	-	•	•	-	•	•	•
shell	KS	•	•	-	•	•	-	•	•	•

LITE LINE

SM Estratificado mate	Carcasa	Costado visto	W 19	WR 19	W 50	W 100	Pilastras	XW5/ XW6	Zócalos	Estantes
bianco	KS	•	•	-	•	•	-	•	•	•
magnolia	-	•	•	-	•	•	-	•	•	•
optiwhite	-	•	•	-	•	•	-	•	•	•
shell	-	•	•	-	•	•	-	•	•	•

NEW LINE

SM Estratificado mate	Carcasa	Costado visto	W 19	WR 19	W 50	W 100	Pilastras	XW5/ XW6	Zócalos	Estantes
bianco	KS	•	•	-	-	-	-	•	•	•
magnolia	-	•	•	-	-	-	-	•	•	•
optiwhite	-	•	•	-	-	-	-	•	•	•
shell	-	•	•	-	-	-	-	•	•	•

PREMIUM LINE

SMF Fenix	Carcasa	Costado visto	W 19	WR 19	W 50	W 100	Pilastras	XW5/ XW6	Zócalos	Estantes
bianco	KS	•	•	-	•	-	-	•	•	-
negro	KS	•	•	-	•	-	-	•	•	-
bromo	-	•	•	-	•	-	-	•	•	-
cacao	-	•	•	-	•	-	-	•	•	-
gris claro	-	•	•	-	•	-	-	•	•	-
blanco kos	KS	•	•	-	•	-	-	•	•	-
londra	-	•	•	-	•	-	-	•	•	-
azul noche	-	•	•	-	•	-	-	•	•	-
optiwhite	KS	•	•	-	•	-	-	•	•	-
rosso	-	•	•	-	•	-	-	•	•	-
verde	-	•	•	-	•	-	-	•	•	-
cemento blanco	-	SZ	SZ	-	SZ	SZ	-	•	SZ	-

SZ HPL cemento claro

Acabados en melamina

Acabados mates

Acabados brillantes

Acabados polilaminados

Wood Range + Wood Specials

Tiradores, encimeras, tablas de acabados, modelos descatalogados

Tabla de acabados mates

PREMIUM LINE

XTR Xtreme	Carcasa	Costado visto	W 19	WR 19	W 50	W 100	Pilastras	XW5/ XW6	Zócalos	Estantes
negro	KS	•	•	-	•	•	-	•	•	-
grafito	KS	•	•	-	•	•	-	•	•	-
optiwhite	KS	•	•	-	•	•	-	•	•	-
orion	KS	•	•	-	•	•	-	•	•	-
shell	KS	•	•	-	•	•	-	•	•	-
snow	KS	•	•	-	•	•	-	•	•	-

PREMIUM LINE

ACM - Acrílico mate	Carcasa	Costado visto	W 19	WR 19	W 50	W 100	Pilastras	XW5/ XW6	Zócalos	Estantes
aureo	KS kiesel	•	•	-	-	-	-	•	•	KS kiesel
bianco	KS	•	•	-	-	-	-	•	•	KS*
negro	KS	•	•	-	-	-	-	•	•	KS*
grafito	KS	•	•	-	-	-	-	•	•	KS*
luminoso	•	•	•	-	-	-	-	•	•	-
opale	•	•	•	-	-	-	-	•	•	-
snow	KS	•	•	-	-	-	-	•	•	KS*
terricio	-	•	•	-	-	-	-	•	•	-
titanio	-	•	•	-	-	-	-	•	•	-

KS* Únicamente colores homogéneos, disponibles para carcasa. Los estantes solo están disponibles en acabados KS solamente.

PREMIUM LINE

ML Lacado mate	Carcasa	Costado visto	W 19	WR 19	W 50	W 100	Pilastras	XW5/ XW6	Zócalos	Estantes
cobre	-	•	•	-	-	-	-	-	•	-
cobre cepillado	-	•	•	-	-	-	-	-	•	-
oro	-	•	•	-	-	-	-	-	•	-
oro cepillado	-	•	•	-	-	-	-	-	•	-
snow	KS	•	•	-	•	-	-	•	•	-
RAL, Sikkens, NCS	-	•	•	-	•	-	-	•	•	-

LITE LINE

ML Lacado mate	Carcasa	Costado visto	W 19	WR 19	W 50	W 100	Pilastras	XW5/ XW6	Zócalos	Estantes
snow	-	•	•	-	•	-	-	•	•	-

PREMIUM LINE

MLMi Laca estructurada Micron	Carcasa	Costado visto	W 19	WR 19	W 50	W 100	Pilastras	XW5/ XW6	Zócalos	Estantes
bianco	KS	•	•	•	•	-	-	•	•	KS
negro	KS	•	•	•	•	-	-	•	•	KS
carbón	KS	•	•	•	•	-	-	•	•	KS
grafito	KS	•	•	•	•	-	-	•	•	KS
cachemir	KS	•	•	•	•	-	-	•	•	KS
grava	KS	•	•	•	•	-	-	•	•	KS
londra	*	•	•	•	•	-	-	•	•	*
marone	*	•	•	•	•	-	-	•	•	*
azul noche	*	•	•	•	•	-	-	•	•	*
musgo	*	•	•	•	•	-	-	•	•	*
oliva	*	•	•	•	•	-	-	•	•	*
orion	(N) KS	•	•	•	•	-	-	•	•	KS
seta	*	•	•	•	•	-	-	•	•	*
shell	(N) KS	•	•	•	•	-	-	•	•	KS
snow	(N) KS	•	•	•	•	-	-	•	•	KS
verde abeto	*	•	•	•	•	-	-	•	•	*
urbano	*	•	•	•	•	-	-	•	•	*
RAL, Sikkens, NCS	*	•	•	•	•	-	-	•	•	*

Tabla de acabados mates

PREMIUM LINE

MLSO Lacado mate/Soft	Carcasa	Costado visto	W 19	WR 19	W 50	W 100	Pilastras	XW5/ XW6	Zócalos	Estantes
bianco	KS	•	•	•	•	-	-	•	•	KS
negro	KS	•	•	•	•	-	-	•	•	KS
carbón	KS	•	•	•	•	-	-	•	•	KS
grafito	KS	•	•	•	•	-	-	•	•	KS
cachemir	KS	•	•	•	•	-	-	•	•	KS
grava	KS	•	•	•	•	-	-	•	•	KS
londra	*	•	•	•	•	-	-	•	•	*
marone	*	•	•	•	•	-	-	•	•	*
azul noche	*	•	•	•	•	-	-	•	•	*
musgo	*	•	•	•	•	-	-	•	•	*
oliva	*	•	•	•	•	-	-	•	•	*
orion	(N) KS	•	•	•	•	-	-	•	•	KS
seta	*	•	•	•	•	-	-	•	•	*
shell	(N) KS	•	•	•	•	-	-	•	•	KS
snow	(N) KS	•	•	•	•	-	-	•	•	KS
verde abeto	*	•	•	•	•	-	-	•	•	*
urbano	*	•	•	•	•	-	-	•	•	*

PREMIUM LINE

Lacado mate UVM	Carcasa	Costado visto	W 19	WR 19	W 50	W 100	Pilastras	XW5/ XW6	Zócalos	Estantes
aqua	-	•	•	-	-	-	-	•	•	-
bianco	KS	•	•	-	-	-	-	•	•	KS*
negro	KS	•	•	-	-	-	-	•	•	KS*
carbón	KS	•	•	-	-	-	-	•	•	KS*
acabado dorado	-	•	•	-	-	-	-	•	•	-
delfín	KS	•	•	-	-	-	-	•	•	KS*
fango	-	•	•	-	-	-	-	•	•	KS*
cachemir	KS	•	•	-	-	-	-	•	•	KS*
grava	KS	•	•	-	-	-	-	•	•	KS*
laguna	-	•	•	-	-	-	-	•	•	-
océano	-	•	•	-	-	-	-	•	•	-
pizarra	KS	•	•	-	-	-	-	•	•	KS*
snow	KS	•	•	-	-	-	-	•	•	KS*
acero dorado-marrón	-	•	•	-	-	-	-	•	•	-

KS* Únicamente colores homogéneos, disponibles para carcasa. Los estantes solo están disponibles en acabados KS solamente.

LITE LINE

Lacado mate UVM	Carcasa	Costado visto	W 19	WR 19	W 50	W 100	Pilastras	XW5/ XW6	Zócalos	Estantes
aqua	-	•	•	-	-	-	-	•	•	-
bianco	KS	•	•	-	-	-	-	•	•	KS*
negro	-	•	•	-	-	-	-	•	•	KS*
carbón	KS	•	•	-	-	-	-	•	•	KS*
acabado dorado	-	•	•	-	-	-	-	•	•	-
delfín	KS	•	•	-	-	-	-	•	•	KS*
fango	-	•	•	-	-	-	-	•	•	KS*
cachemir	-	•	•	-	-	-	-	•	•	KS*
grava	-	•	•	-	-	-	-	•	•	KS*
laguna	-	•	•	-	-	-	-	•	•	-
océano	-	•	•	-	-	-	-	•	•	-
pizarra	KS	•	•	-	-	-	-	•	•	KS*
snow	-	•	•	-	-	-	-	•	•	KS*
acero dorado-marrón	-	•	•	-	-	-	-	•	•	-

KS* Únicamente colores homogéneos, disponibles para carcasa. Los estantes solo están disponibles en acabados KS solamente.

Tabla de acabados brillantes

PREMIUM LINE

LM Lacado metálico	Carcasa	Costado visto	W 19	WR 19	W 50	W 100	Pilastras	XW5/ XW6	Zócalos	Estantes
bronce oscuro	-	•	•	-	•	•	-	•	•	-
bronce claro	-	•	•	-	•	•	-	•	•	-
silver	-	•	•	-	•	•	-	•	•	-
titan	-	•	•	-	•	•	-	•	•	-

PREMIUM LINE

BT Superficie Béton	Carcasa	Costado visto	W 19	WR 19	W 50	W 100	Pilastras	XW5/ XW6	Zócalos	Estantes
claro	-	•	•	-	•	•	-	•	•	-
oscuro	-	•	•	-	•	•	-	•	•	-
medio	-	•	•	-	•	•	-	•	•	-
superclaro	-	•	•	-	•	•	-	•	•	-

PREMIUM LINE

EG Melamina brillante	Carcasa	Costado visto	W 19	WR 19	W 50	W 100	Pilastras	XW5/ XW6	Zócalos	Estantes
bianco	KS	•	•	-	•	•	-	•	•	•
cachemir	KS	•	•	-	•	•	-	•	•	•
optiwhite	KS	•	•	-	•	•	-	•	•	•

LITE LINE

EG Melamina brillante	Carcasa	Costado visto	W 19	WR 19	W 50	W 100	Pilastras	XW5/ XW6	Zócalos	Estantes
bianco	KS	•	•	-	•	•	-	•	•	•
cachemir	-	•	•	-	•	•	-	•	•	•
optiwhite	-	•	•	-	•	•	-	•	•	•

NEW LINE

EG Melamina brillante	Carcasa	Costado visto	W 19	WR 19	W 50	W 100	Pilastras	XW5/ XW6	Zócalos	Estantes
bianco	KS	•	•	-	-	-	-	•	•	•
cachemir	-	•	•	-	-	-	-	•	•	•
optiwhite	-	•	•	-	-	-	-	•	•	•

PREMIUM LINE

SG Estratificado brillante	Carcasa	Costado visto	W 19	WR 19	W 50	W 100	Pilastras	XW5/ XW6	Zócalos	Estantes
bianco	KS	•	•	-	•	•	-	•	•	•
magnolia	KS	•	•	-	•	•	-	•	•	•
optiwhite	KS	•	•	-	•	•	-	•	•	•
snow	KS	•	•	-	•	•	-	•	•	•

LITE LINE

SG Estratificado brillante	Carcasa	Costado visto	W 19	WR 19	W 50	W 100	Pilastras	XW5/ XW6	Zócalos	Estantes
bianco	KS	•	•	-	•	•	-	•	•	•
magnolia	-	•	•	-	•	•	-	•	•	•
optiwhite	-	•	•	-	•	•	-	•	•	•
snow	-	•	•	-	•	•	-	•	•	•

NEW LINE

SG Estratificado brillante	Carcasa	Costado visto	W 19	WR 19	W 50	W 100	Pilastras	XW5/ XW6	Zócalos	Estantes
bianco	KS	•	•	-	-	-	-	•	•	•
magnolia	-	•	•	-	-	-	-	•	•	•
optiwhite	-	•	•	-	-	-	-	•	•	•
snow	-	•	•	-	-	-	-	•	•	•

Tabla de acabados brillantes

PREMIUM LINE

UVHG UV-Lacado brillante	Carcasa	Costado visto	W 19	WR 19	W 50	W 100	Pilastras	XW5/ XW6	Zócalos	Estantes
bianco	KS	•	•	-	-	-	-	•	-	SG
grigio	KS	•	•	-	-	-	-	•	•	-
cachemir	KS	•	•	-	-	-	-	•	-	EG
optiwhite	KS	•	•	-	-	-	-	•	-	SG
snow	KS	•	•	-	-	-	-	•	-	SG

LITE LINE

UVHG UV-Lacado brillante	Carcasa	Costado visto	W 19	WR 19	W 50	W 100	Pilastras	XW5/ XW6	Zócalos	Estantes
bianco	KS	•	•	-	-	-	-	•	-	SG
grigio	-	•	•	-	-	-	-	•	•	-
cachemir	-	•	•	-	-	-	-	•	-	EG
optiwhite	-	•	•	-	-	-	-	•	-	SG
snow	-	•	•	-	-	-	-	•	-	SG

NEW LINE

UVHG UV-Lacado brillante	Carcasa	Costado visto	W 19	WR 19	W 50	W 100	Pilastras	XW5/ XW6	Zócalos	Estantes
bianco	KS	•	•	-	-	-	-	•	-	SG
grigio	-	•	•	-	-	-	-	•	•	-
cachemir	-	•	•	-	-	-	-	•	-	EG
optiwhite	-	•	•	-	-	-	-	•	-	SG
snow	-	•	•	-	-	-	-	•	-	SG

PREMIUM LINE

LG Lacado brillante	Carcasa	Costado visto	W 19	WR 19	W 50	W 100	Pilastras	XW5/ XW6	Zócalos	Estantes
bianco	KS	•	•	-	•	-	-	•	•	SG
snow	KS	•	•	-	•	-	-	•	•	SG
RAL, Sikkens, NCS	-	•	•	-	•	-	-	•	•	-

Los acabados en laca brillante LG se pueden combinar con materiales en acabado estratificado brillante SG

LITE LINE

LG Lacado brillante	Carcasa	Costado visto	W 19	WR 19	W 50	W 100	Pilastras	XW5/ XW6	Zócalos	Estantes
bianco	KS	•	•	-	•	-	-	•	•	SG
snow	-	•	•	-	•	-	-	•	•	SG

Los acabados en laca brillante LG se pueden combinar con materiales en acabado estratificado brillante SG

PREMIUM LINE

ACG - Acrílico brillante	Carcasa	Costado visto	W 19	WR 19	W 50	W 100	Pilastras	XW5/ XW6	Zócalos	Estantes
bianco	KS	•	•	-	-	-	-	•	•	-
negro	KS	•	•	-	-	-	-	•	•	-
fumo	-	•	•	-	-	-	-	•	•	-
cachemir	KS	•	•	-	-	-	-	•	•	-
snow	KS	•	•	-	-	-	-	•	•	-

PREMIUM LINE

F1 Knotty raw, Rechapado grueso nudoso, arenado y cepillado	Carcasa	Costado visto	Costados decorativos	Costados ranurados	XW5/ XW6	Zócalos	Estantes
beachwood	-	•	•	•	•	•	-
bianco	KS	•	•	•	•	•	-
negro	KS	•	•	•	•	•	-
tiza	-	•	•	•	•	•	-
castaño	-	•	•	•	•	•	-
driftwood	-	•	•	•	•	•	-
grafito	KS	•	•	•	XW5	•	-
nature	-	•	•	•	•	•	-
oliva	-	•	•	•	•	•	-
pastell loam	-	•	•	•	XW5	•	-
pastell shadow	-	•	•	•	XW5	•	-
pastell smoke	-	•	•	•	XW5	•	-
playa	-	•	•	•	XW5	•	-
shell	KS	•	•	•	•	•	-
RAL, Sikkens, NCS	-	•	•	•	•	•	-

Tabla de acabados Wood Range + Wood Specials

F2 Knotty brushed, Rechapado nudoso, cepillado profundo	Carcasa	Costado visto	Costados decorativos	Costados ranurados	XW5/XW6	KL/LL	Pilastras	Casa de Campo	Zócalos	Estantes	M
beachwood	-	•	•	•	•	-	-	-	•	•	Pilastra cuadrada
bianco	KS	•	•	•	•	40/41	M	•	•	•	
negro	KS	•	•	•	•	40/41	M	•	•	•	
chalk	-	•	•	•	•	-	-	-	•	•	
castaño	-	•	•	•	•	-	-	-	•	•	
driftwood	-	•	•	•	•	-	-	-	•	•	
nature	-	•	•	•	•	-	-	-	•	•	
real-nature	-	•	•	-	•	-	-	-	•	•	
oliva	-	•	•	•	•	40/41	M	•	•	•	
shell (N)	KS	•	•	•	•	40/41	M	•	•	•	
nogal	-	•	•	•	•	-	-	-	•	•	
RAL, Sikkens, NCS	-	•	•	•	•	40/41	M	•	•	•	

F3 Striped brushed, Rechapado fino poco nudoso, cepillado superficial	Carcasa	Costado visto	Costados decorativos	Costados ranurados	XW5/XW6	KL/LL	Pilastras	Casa de Campo	Zócalos	Estantes	M
beachwood	-	•	•	•	•	-	-	-	•	•	Pilastra cuadrada
bianco	KS	•	•	•	•	40/41	M	•	•	•	
negro	KS	•	•	•	•	40/41	M	•	•	•	
chalk	-	•	•	•	•	-	-	-	•	•	
castaño	-	•	•	•	•	-	-	-	•	•	
driftwood	-	•	•	•	•	-	-	-	•	•	
nature	-	•	•	•	•	-	-	-	•	•	
oliva	-	•	•	•	•	40/41	M	•	•	•	
shell (N)	KS	•	•	•	•	40/41	M	•	•	•	
nogal	-	•	•	•	•	-	-	-	•	•	
RAL, Sikkens, NCS	-	•	•	•	•	40/41	M	•	•	•	

F4 Silky smart, Satinado, lacado	Carcasa	Costado visto	Costados decorativos	Costados ranurados	XW5/XW6	KL/LL	Pilastras	Casa de Campo	Zócalos	Estantes	M
bianco	KS	•	•	•	-	40/41	M	•	•	•	Pilastra cuadrada
negro	KS	•	•	•	-	40/41	M	•	•	•	
oliva	-	•	•	•	-	40/41	M	•	•	•	
shell (N)	KS	•	•	•	-	40/41	M	•	•	•	
RAL, Sikkens, NCS	-	•	•	•	-	40/41	M	•	•	•	

Tabla de conversión

Oak-Line → Wood Range + Wood Specials

NUEVA DENOMINACIÓN		ANTERIORMENTE			
Nombre del modelo		Wood Range	Wood Specials	Equivalente	Nombre en Oak Line
MERINO H/V	F1	•		< >	LEGNO H/V
SPLIT-PLANK OAK V	F1	•		< >	PLANK-OAK anticato
TELAIO	F1	•		< >	TELAIO anticato
CADRE	F1	•		< >	CADRE anticato
ORBITA	F1		•	< >	ORBITA anticato
STRETTO	F1	•		< >	STRETTO anticato
RIPIENO	F1		•	< >	RIPIENO anticato
ROUGH ZERO+R15	F1		•	< >	ROUGH ZERO+R15
MERINO H/V	F2	•		< >	MERINO anticato
SPLIT OAK H/V	F2	•		< >	SPLIT-OAK H/V
LAMELLA	F2	•		< >	LAMELLA anticato
REAL-OAK H/V	F2		•	< >	REAL-OAK H/V anticato
BLACK-LINE	F3		•	< >	BLACK-LINE
NOTCHO	F3		•	< >	NOTCHO
TOSCANA	F4	•		< >	TOSCANA (normal, nicht PM)

Información más detallada en página 55

Modelos descatalogados 2022

PREMIUM LINE

Frentes/Puertas			
CASTLE grafito	CASTLE snow	CROSS reno	EDGE REAL-OAK completo
EDGE SHERWOOD completo	EDGE SINCRONO completo	ELEGANCE SOFT magnolia	EXTREM cachemir
EXTREM sharky	GROOVE grafito	GROOVE snow	INCAVO completo
INSPIRATION SOFT magnolia	INTENSE completo	LUNA MICRON gris azulado	LUNA MICRON melocotón
LUNA MICRON óxido	LUNA MICRON sharky	LUNA MICRON taupe	LUNA SOFT magnolia
MEDA grafito	MEDA snow	MERINO grafito	MERINO loam
METALLICO completo	MILA SOFT magnolia	MODERNO grafito	MODERNO snow
OPACO antracita	PORTO w/ grafito	PLANK-OAK loam	REAL-OAK H/V tiramisú
RIPIENO loam	RUPE ash	RUPE sand	SHERWOOD richmond
SINCRONO darkwood	SINCRONO nordic	SINCRONO roble stormy	STEP completo
STYLE Extrem optiwhite	STYLE Fenix optiwhite	STYLE Touch white	TELAIO grafito
TOSCANA grafito	TOSCANA magnolia		

Anotación:
Los modelos de la siguiente lista se encuentran disponibles hasta diciembre de 2022!

Colores de carcasa			
fango 014	vicenza oak claire 153		

Modelos descatalogados 2022

LITE LINE

Frentes/Puertas			
EDGE SHERWOOD completo	EDGE SINCRONO completo	OPACO antracita	RUPE ash
RUPE sand	SINCRONO roble stormy		

Anotación:
Los modelos de la siguiente lista se encuentran disponibles hasta diciembre de 2022!

Modelos descatalogados 2022

NEW LINE

Frentes/Puertas			
PORTO w/ grafito	SINCRONO nordic		

Anotación:
Los modelos de la siguiente lista se encuentran disponibles hasta diciembre de 2022!

Modelos descatalogados 2022

LITE LINE**PREMIUM LINE****NEW LINE**

Tiradores			
226	313	425	440
441			

Colores de la encimera			
1020 CODY WEISS	1032 ESCHE MOLINA SAND	1046 KRISTALLWEISS SOLID COLOR	5000 FENIX ACCIAIO HAMILTON

Schröder Küchen GmbH & Co. KG

Oepings Brink 7 – D-32278 Kirchlengern
Fon +49 (0) 52 23 / 97 35-0 – Fax +49 (0) 52 23 / 97 35-35/-341
info@schroeder-kuechen.de – www.schroeder-kuechen.de